

SKILL[®]

Surgical Instruments

CARDIOVASCULAR & THORACIC INSTRUMENTS

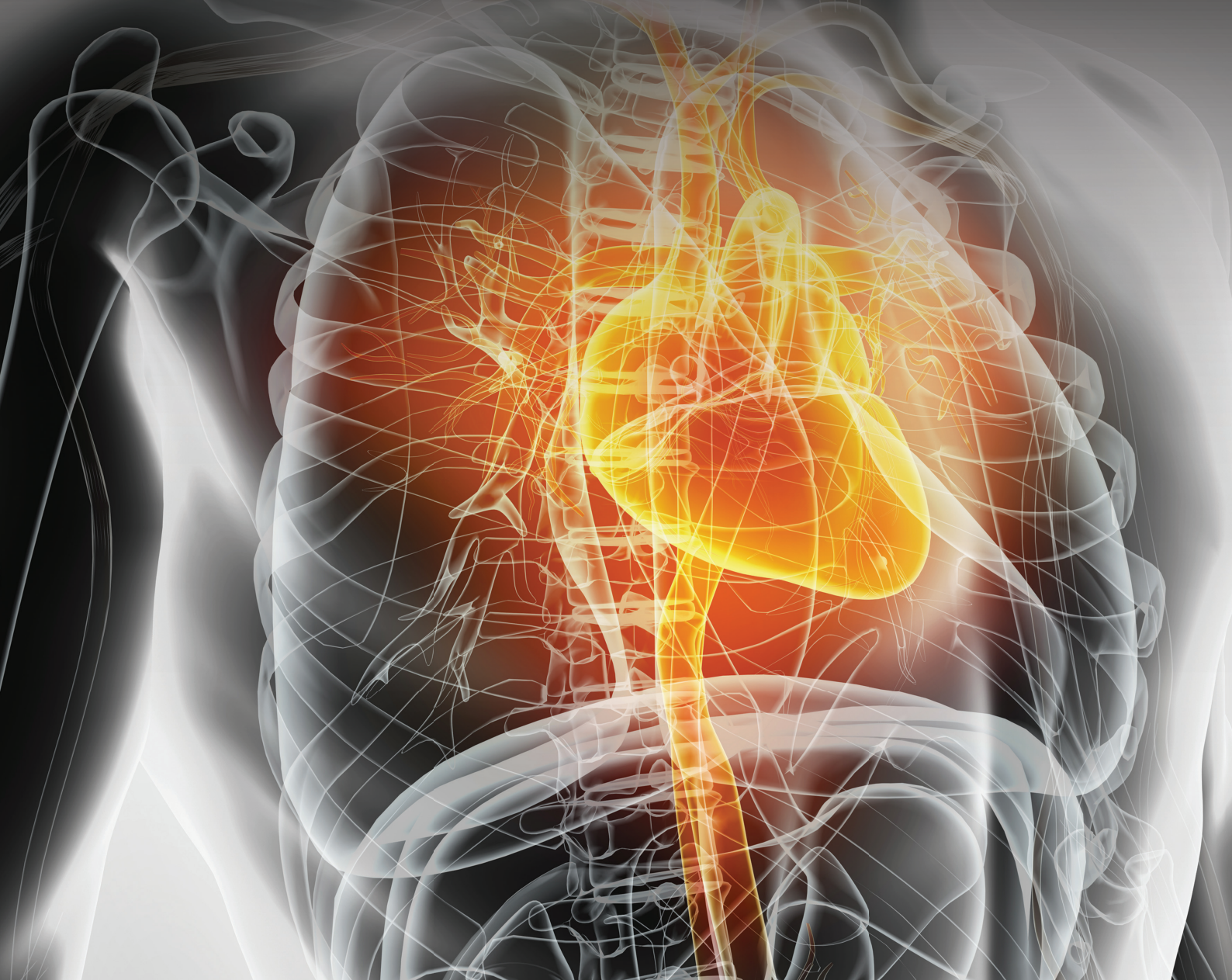



SKILL® The World's Best Surgical Instruments

All **SKILL®** Instruments are manufactured on a three-pillar principle, namely raw material quality, skilled craftsmanship as well as precise and validated heat treatment and tempering.

Our goal is achieved by using German Forgings and German Steel for the production of our **SKILL®** Instruments. Using only German Craftsmanship, engineering and know-how throughout the manufacturing process along with the validated heat treatment is a necessity in the production of our **SKILL®** Instruments.

SKILL® Instruments are manufactured in Germany according to the EU Directive 93/42/EWG, as well as the following ISO Standards;

ISO: 9001
ISO:13458
ISO: 7153-1

No compromise is made on the quality of a **SKILL®** Surgical Instrument. The **SKILL®** short chain of supply allows clients to purchase the highest quality of Instrument at the most competitive pricing.

SKILL® Instruments offer the Surgeon a heightened sense of Instrument control allowing the Surgeon to greatly reduce the trauma and risk associated with Surgery.

OPERATE WITH SKILL®, OPERATE WITH US.

SKILL® Instruments carry a Lifetime warranty which covers any material defect or faulty manufacturing.

SKILL® Instruments will be repaired or replaced free of charge without compromise to the product in the event of a valid claim.

SKILL® Instruments are to be returned to the authorised distributor for maintenance, any work carried out by an unauthorised person will void the warranty.

No part of the Catalogue may be copied, forwarded or distributed without the express written consent given by the Manufacturer or its Distributor.

Operate with **SKILL®**
Surgical Instruments

INDEX

MICRO SCISSORS	5
MICRO FORCEPS	113
MICRO NEEDLE HOLDERS	133
MICRO VASCULAR CLAMPS	171
CARDIOVASCULAR RETRACTORS	261
MICS & VATS CARDIAC INSTRUMENTS	363
SPECIALITY INSTRUMENTS	453



BLACK COATED SURGICAL INSTRUMENTS



TUNGSTEN CARBIDE INSERTS



TITANIUM SURGICAL INSTRUMENTS



DIAMOND DUST/TC DUST INSERTS

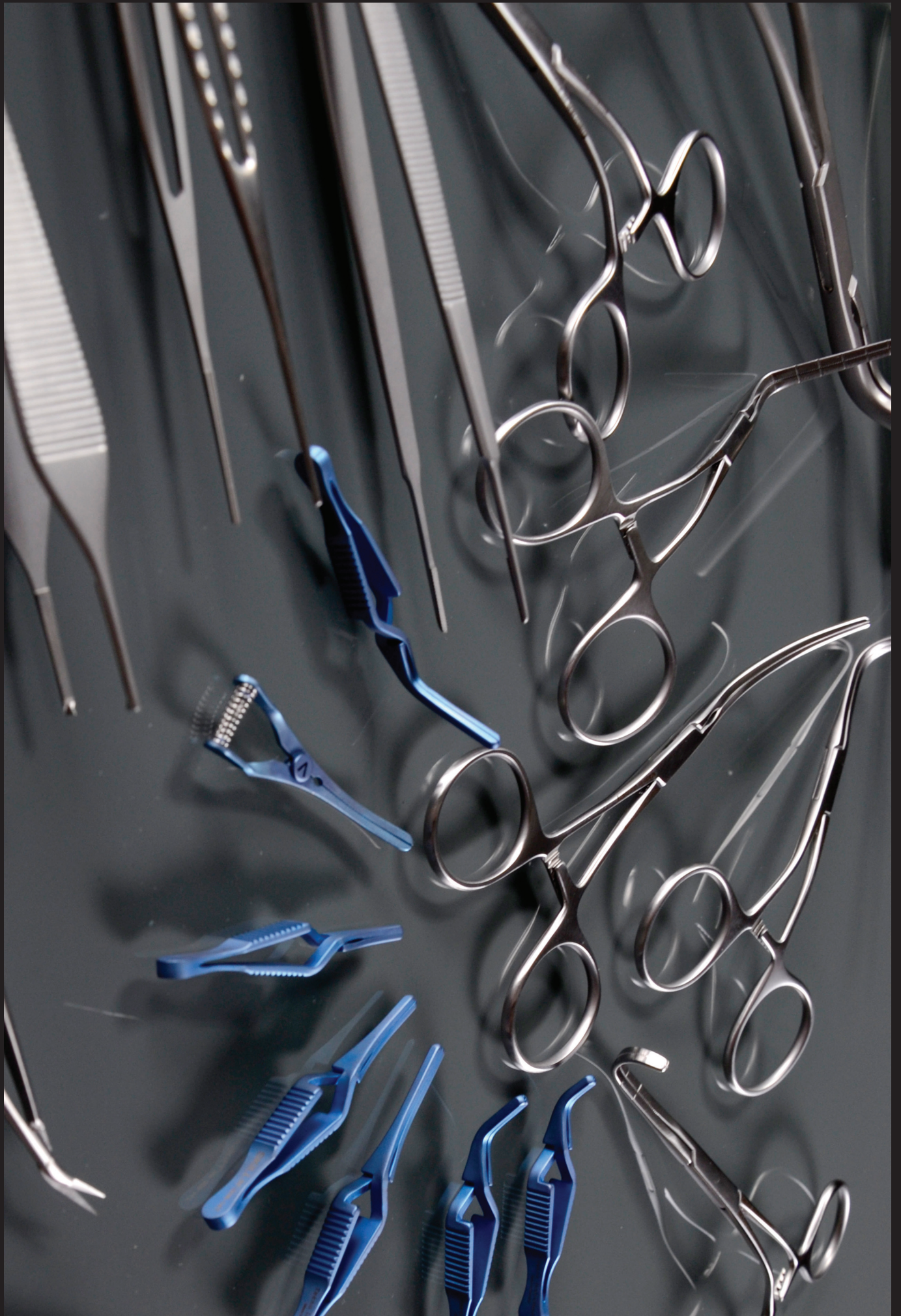

SKILL[®]

Surgical Instruments

SCISSORS

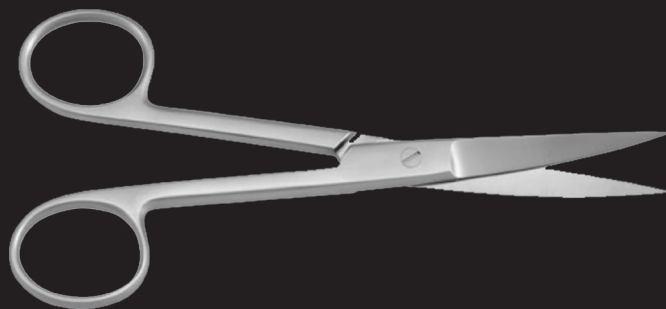
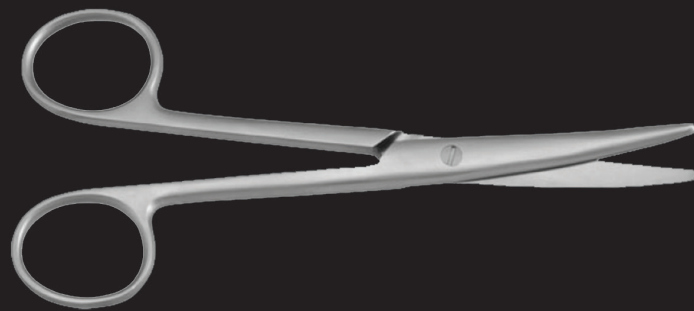
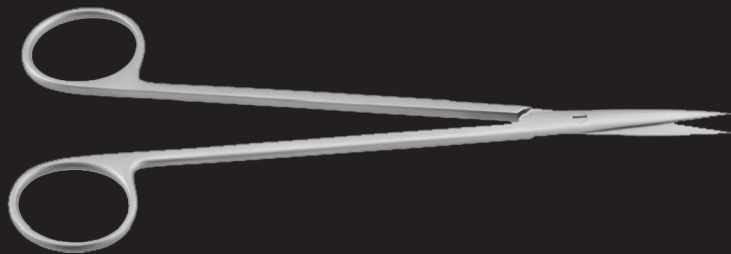

Index Scissors

SURGICAL SCISSORS

Standard	9-10
Grazil	10-12
Deaver Mixer Richter Fergusson	12-13
Doyen	13-14
Sims	14-16
Dubois Wertheim	16
Crafoord Braun-Stadler Waldmann	17
Mod. USA Schumacher	18
Bush	18-19
Mayo	19-21
Resano	21
Lloyd-Davies	22
Stelzner	23
Metzenbaum	24-26
Lillehei-Potts	26
Metzenbaum-Fino-S	27
Lexer Starbismus	28
Thorek Gorney Kilner (Ragnell)	29
Jameson Reynolds	30
Toennis	30-31
DeBakey Aufricht McIndoe	31
Boettcher Martin Prince Dean	32
Good Potts-Smith Kahn	33
Salyer Kaye	34
Fomon Fomon-Fino	34-35
Cottle Heymann Olivecrona	36
Tessier Knight Fomon Landolt	37
Cottle-Masing Cottle Wilmer-Walter	38
Kelly Joseph Peck-Joseph Chadwich	39
Quinby Sanvenero La Grange	40
Goldmann-Fox Goldmann-Fox-S	41
Wagner Wagner-Standard Kilner Litler	41-42
Stevens Tenotomy	43
Iris Iris Standard	43-44
O'Brien	44
Iris-Fino Iris-Anatomy Bonn Graefe	45
Ribbon-Stevens Tenotomy Ribbon-Iris Jabaley	46
Satinsky Bozemann Klinkenbergh-Loth Strully	47
Church Jorgenson Dandy Classon	48
Potts-Smith Locklin	49, 52
Schmieden-Taylor	49
DeBakey Favaloro	50-51
Potts-De Martel	52
Mills Dietrich-Hegemann	53
Spencer-Fino Spencer Shortbrent Locklin Northbent	54
Littauer Littler Buck Eiselsberg Heath Schoemaker-Loth	55
Beebee Guilford-Wright Universal Harvey	56

SUPERCUT SCISSORS

Standard Sims	58
Sims-Siebold-S Waldmann Mayo	59
Mayo-Harrington Mayo-Stille	60
Metzenbaum Metzenbaum-Fino	61
Metzenbaum-Baby Lexer Kilner (Ragnell) Jameson	62
Reynolds Heymann Kelly Stevens Tenotomy	63
Iris Jabaley	64
Potts-Smith Dietrich-Hegemann	65

SCISSORS WITH TUNGSTEN CARBIDE EDGES

Standard	67
Mixer Waldmann	68
Sims	69-70
Mayo Mayo-Harrington Wertheim	71-72
Mayo-Stille Metzenbaum Metzenbaum-Fino Metzenbaum-Fino-S	73-76
Mayo-Lexer Lexer Lexer Thorek	77
Joseph Kilner Jameson Reynolds	78-79
Metzenbaum-Lahey Toennis-Adson	79
Dean Fomon Cottle	80
Gorney Fomon Kaye Stella	81
Gorney-Freeman Freeman-Kaye Freeman-Gorney	82
Kelly Joseph Goldman-Fox Wagner	83
Iris Locklin Locklin-S	84
DeBakey Potts-Smith	85
Dietrich-Hegemann Universal Smith	86
Mayo Metzenbaum	87

SUPERCUT TITANIUM-NITRIDE SCISSORS

Sims Mayo Mayo-Harrington	89
Mayo-Stille Metzenbaum	90
Metzenbaum-Fino Lexer	91
Jameson Reynolds Toennis-Adson Fomon	92
Heymann Gregory Kelly Joseph	93
Stevens Tenotomy Iris Dietrich-Hegemann	94
Potts-de Martel	95
Micro Scissors Round Handle Scissors Flat Handle 18 cm	96-98
Micro Scissors Flat Handle	99
Micro Scissors Round Handle 18 cm	100
Titanium Micro Scissors Bayonet Flat Handle 23 cm	101
Micro Vascular Scissors Flat Handle 7 mm Micro Blades 10 cm	102
Micro Vascular Scissors Flat Handle 10 mm Blades 16 cm 14 mm Blades 12 cm	103
Micro Vascular Scissors Flat Handle 18 cm	104
Micro Vascular Scissors Flat Handle 21 cm	105, 106
Micro Vascular Scissors Round Handle 16 cm	107
Micro Vascular Scissors Round Handle 18 cm	108
Micro Vascular Scissors Round Handle 21 cm	109
Jacobson Micro Scissors Flat Handle Bayonet	110
Jacobson Micro Scissors Flat Handle Bayonet	111

SCISSORS

Surgical Scissors

- Every pair of SKILL scissors is manufactured from high-quality cutter-grade steel. Specially tempered blades, consistent hardness and cutting tests to ensure quality before shipping guaranteed outstanding and continuing cutting performance.

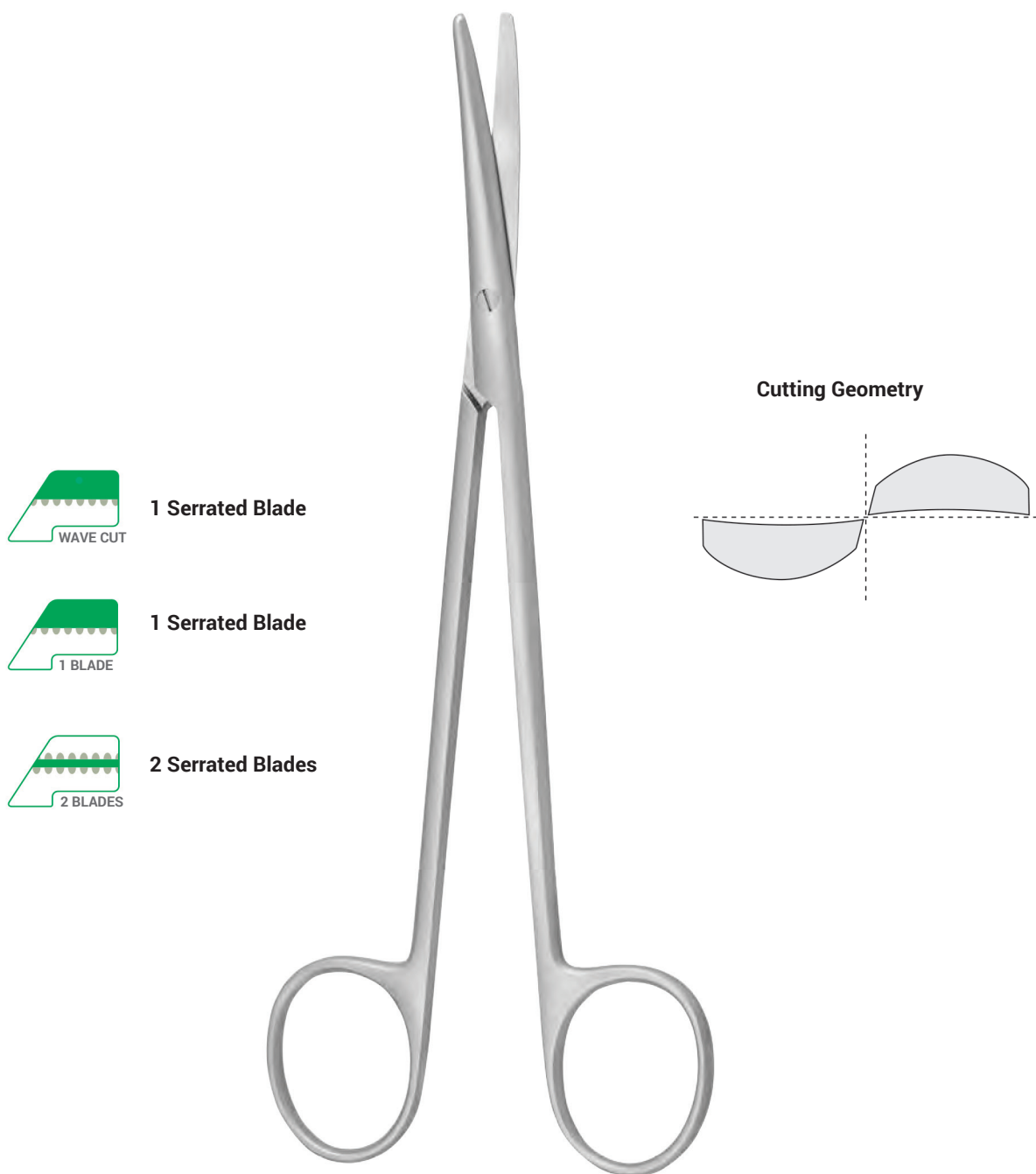



Standard

Fig. 1

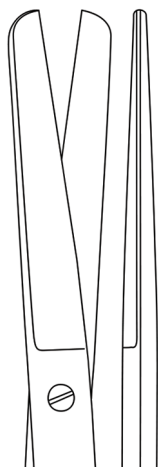

Length	Code
10 cm	BB-0606-10
11 cm	BB-0606-11
13 cm	BB-0606-13
14 cm	BB-0606-14
15 cm	BB-0606-15
16 cm	BB-0606-16
17 cm	BB-0606-17
18 cm	BB-0606-18
20 cm	BB-0606-20



Fig. 1



Length	Code
10 cm	BB-0607-10
11 cm	BB-0607-11
13 cm	BB-0607-13
14 cm	BB-0607-14
15 cm	BB-0607-15
16 cm	BB-0607-16
17 cm	BB-0607-17
18 cm	BB-0607-18
20 cm	BB-0607-20



Fig. 2

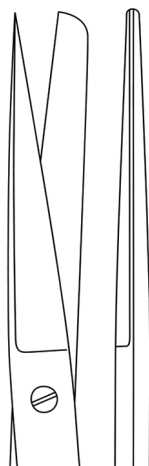

Length	Code
10 cm	BB-0608-10
11 cm	BB-0608-11
13 cm	BB-0608-13
14 cm	BB-0608-14
15 cm	BB-0608-15
16 cm	BB-0608-16
17 cm	BB-0608-17
18 cm	BB-0608-18
20 cm	BB-0608-20



Fig. 2



Length	Code
10 cm	BB-0609-10
11 cm	BB-0609-11
13 cm	BB-0609-13
14 cm	BB-0609-14
15 cm	BB-0609-15
16 cm	BB-0609-16
17 cm	BB-0609-17
18 cm	BB-0609-18
20 cm	BB-0609-20





SCISSORS

Standard

Fig. 3

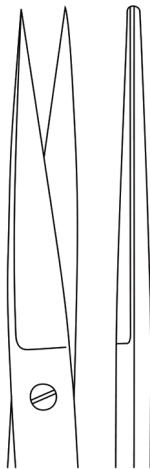

Length	Code
10 cm	BB-0610-10
11 cm	BB-0610-11
13 cm	BB-0610-13
14 cm	BB-0610-14
15 cm	BB-0610-15
16 cm	BB-0610-16
17 cm	BB-0610-17
18 cm	BB-0610-18
20 cm	BB-0610-20

Fig. 3



Length	Code
10 cm	BB-0611-10
11 cm	BB-0611-11
13 cm	BB-0611-13
14 cm	BB-0611-14
15 cm	BB-0611-15
16 cm	BB-0611-16
17 cm	BB-0611-17
18 cm	BB-0611-18
20 cm	BB-0611-20

Grazil

Fig. 1

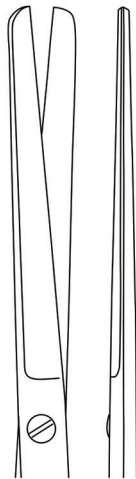

Delicate Pattern

Length	Code
13 cm	BB-0612-13
14 cm	BB-0612-14

Fig. 1

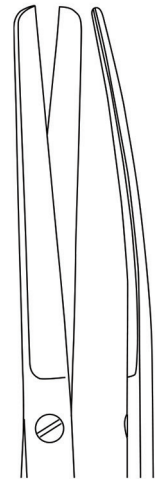

Delicate Pattern

Length	Code
13 cm	BB-0613-13
14 cm	BB-0613-14



Grazil

Fig. 2

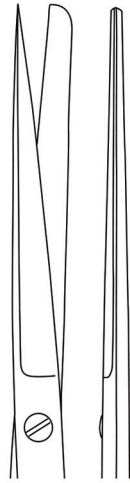

Delicate Pattern

Fig. 2



Delicate Pattern

Length	Code
13 cm	BB-0614-13
14 cm	BB-0614-14

Length	Code
13 cm	BB-0615-13
14 cm	BB-0615-14

Grazil

Fig.3

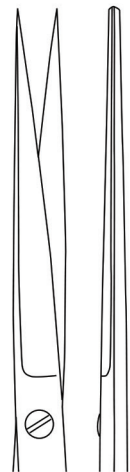

Delicate Pattern

Fig.3



Delicate Pattern

Length	Code
13 cm	BB-0616-13
14 cm	BB-0616-14

Length	Code
13 cm	BB-0617-13
14 cm	BB-0617-14



SCISSORS

Grazil

Fig. 2

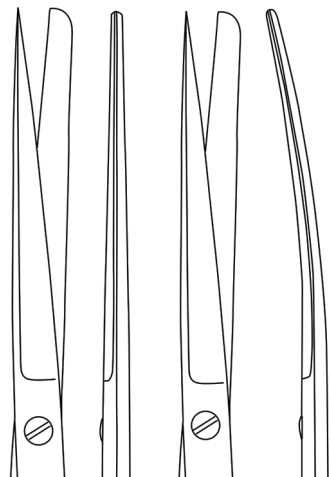

Code
BB-0618-13

Code
BB-0619-13

Delicate Pattern



Length	Code
13 cm	BB-0618-13
13 cm	BB-0619-13

Fig. 2

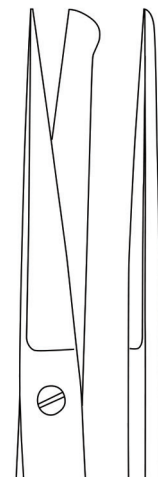

Incision Scissors

Length	Code
13 cm	BB-0620-13
14 cm	BB-0620-14
15 cm	BB-0620-15

Deaver



Code
BB-0340-14

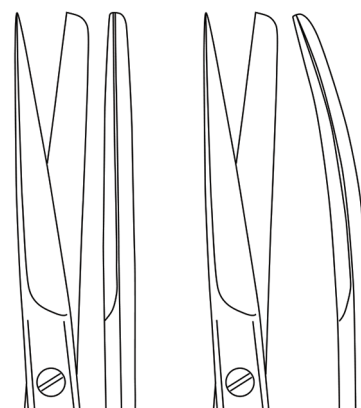

Code
BB-0334-13

Code
BB-0334-14

Length	Code
13 cm	BB-0340-13

Length	Code
13 cm	BB-0334-13
14 cm	BB-0334-14



SCISSORS

Mixer

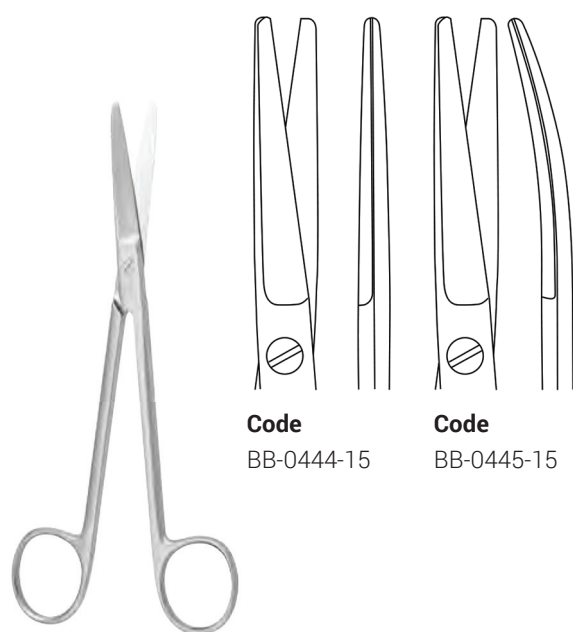

Code
BB-0444-15

Code
BB-0445-15

Length **Code**
15 cm BB-0444-15 - BB-0445-15

Richter

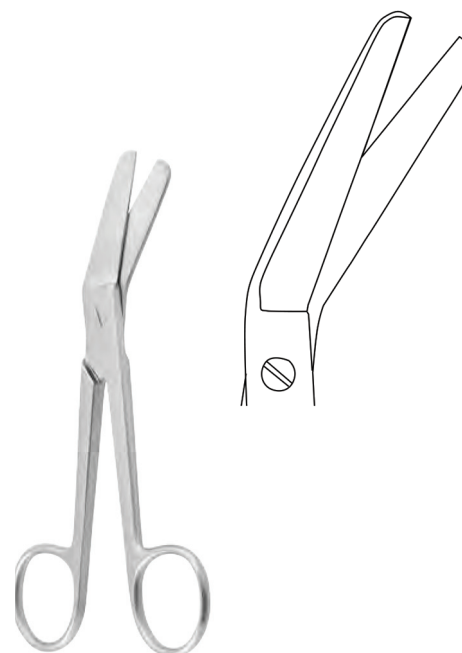

Length **Code**
14 cm BB-0450-14

Fergusson

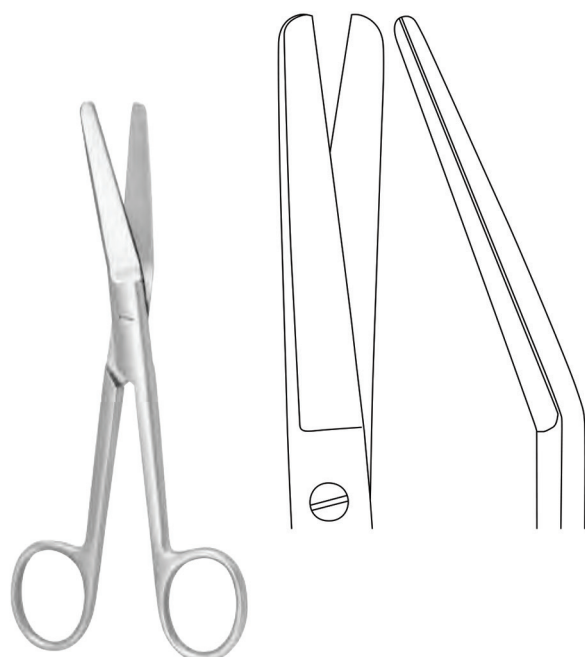

Length **Code**
16 cm BB-0551-16
18 cm BB-0551-18

Doyen

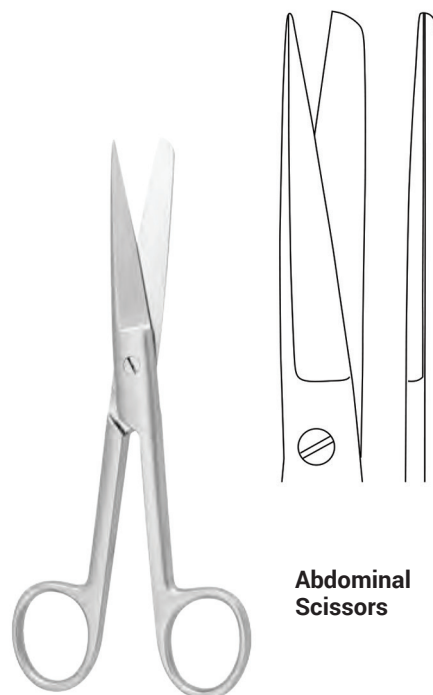

**Abdominal
Scissors**

Length **Code**
16 cm BB-0242-16

SCISSORS

Abdominal Scissors, Uterine Scissors



Doyen

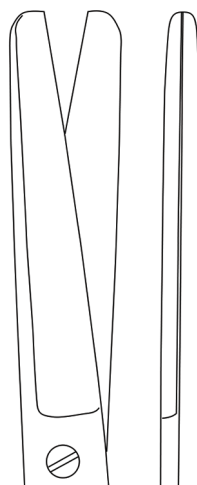

Code
BB-0243-16
BB-0243-18

Abdominal Scissors



Code
BB-0244-16
BB-0244-18

Abdominal Scissors

Length	Code
16 cm	BB-0243-16 - BB-0244-16
18 cm	BB-0243-18 - BB-0244-18

Sims

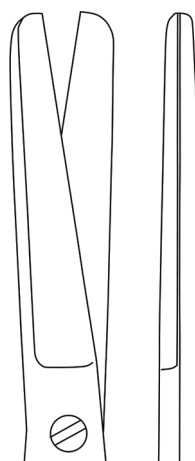

Code
BB-0500-20
BB-0500-23
BB-0500-25

Uterine Scissors



Code
BB-0509-20
BB-0509-23
BB-0509-25

Uterine Scissors

Length	Code
20 cm	BB-0500-20 - BB-0509-20
23 cm	BB-0500-23 - BB-0509-23
25 cm	BB-0500-25 - BB-0509-25



Sims

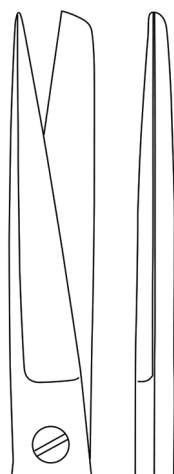

Code
 BB-0510-20
 BB-0510-23
 BB-0510-25



Code
 BB-0511-20
 BB-0511-23
 BB-0511-25

Uterine Scissors

Uterine Scissors

Length	Code
20 cm	BB-0510-20 - BB-0511-20
23 cm	BB-0510-23 - BB-0511-23
25 cm	BB-0510-25 - BB-0511-25



Code
 BB-0512-20
 BB-0512-23
 BB-0512-25



Code
 BB-0513-20
 BB-0513-23
 BB-0513-25

Uterine Scissors

Uterine Scissors

Length	Code
20 cm	BB-0512-20 - BB-0513-20
23 cm	BB-0512-23 - BB-0513-23
25 cm	BB-0512-25 - BB-0513-25



Dubois

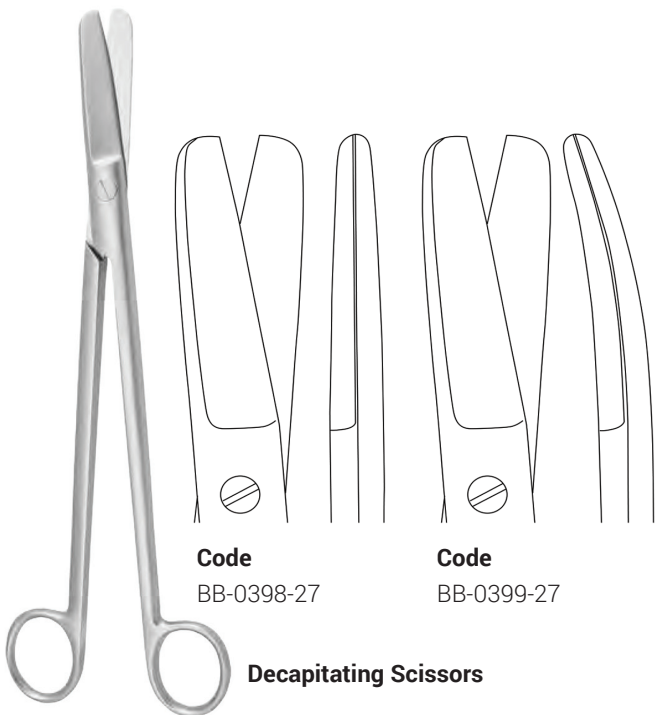

Code
BB-0398-27

Code
BB-0399-27

Decapitating Scissors

Length **Code**
27 cm BB-0398-27 - BB-0399-27

Wertheim

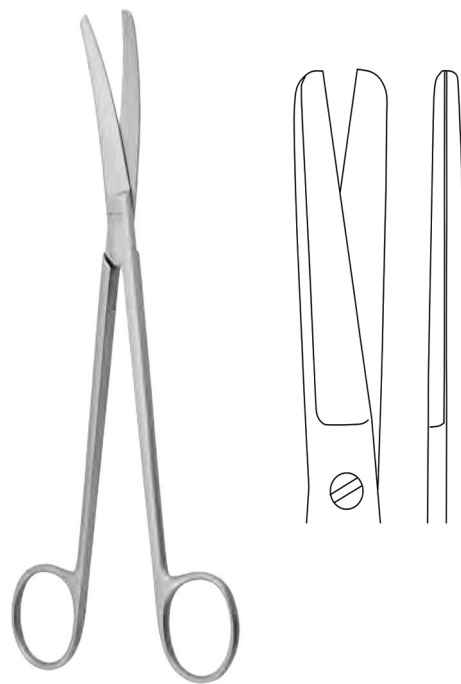

Length **Code**
14 cm BB-0383-14
20 cm BB-0383-20
22 cm BB-0383-22

Sims Siebold-S

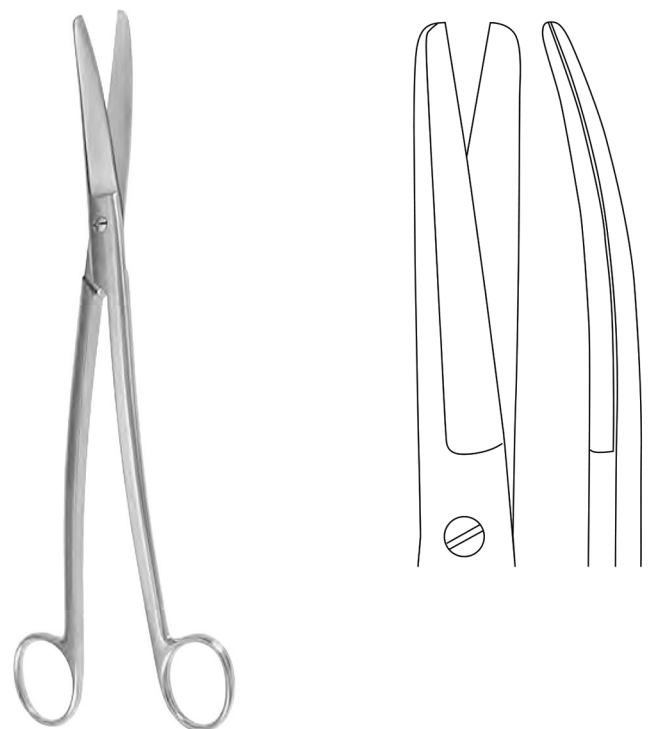

Length **Code**
24 cm BB-0990-24

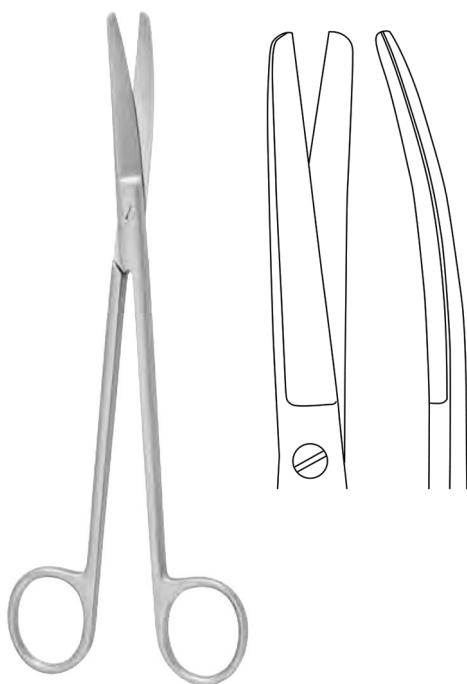

Length **Code**
14 cm BB-0384-14
20 cm BB-0386-20
22 cm BB-0387-22



Crafoord

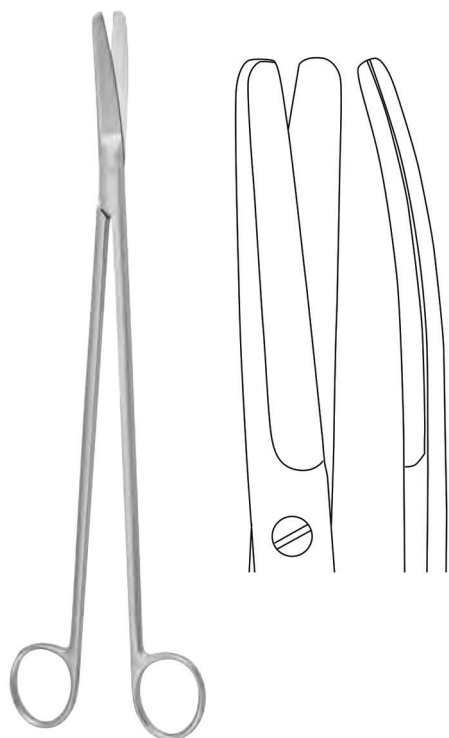

Length	Code
30 cm	BB-0382-30

Braun-Stadler



Perineum Scissors (Episiotomy)

Length	Code
14 cm	BB-0390-14
22 cm	BB-0390-22

Waldmann

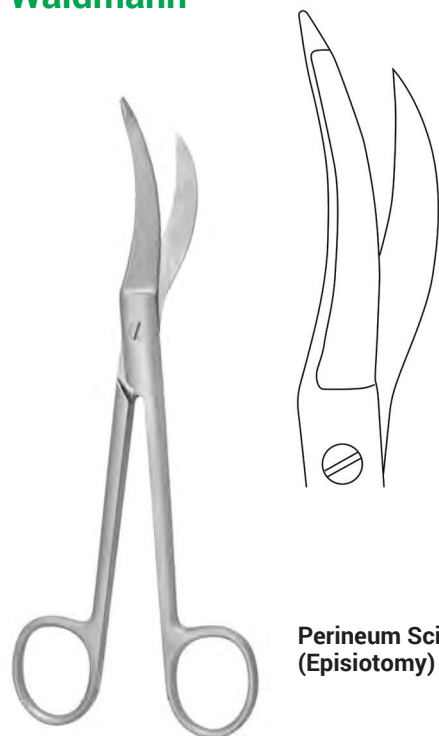

Perineum Scissors (Episiotomy)

Length	Code
18 cm	BB-0396-18

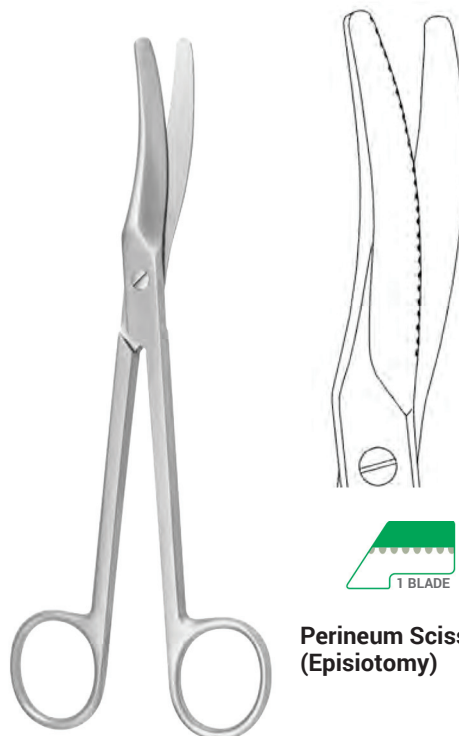

Perineum Scissors (Episiotomy)

Length	Code
18 cm	BB-0397-18



SCISSORS

Surgical Scissors



Mod. USA

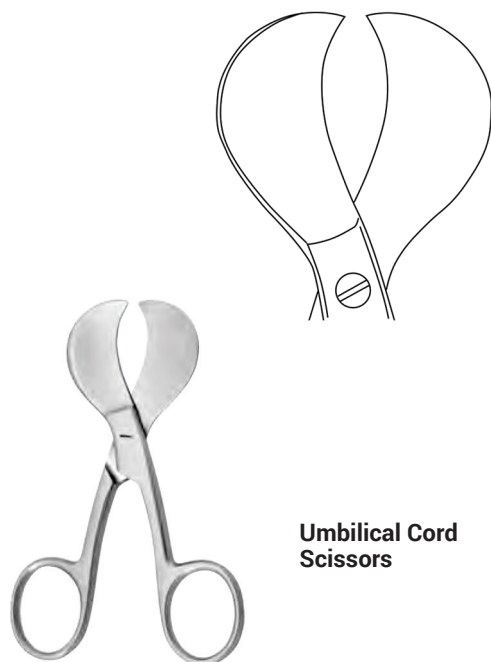

Umbilical Cord Scissors

Length	Code
10 cm	BB-0398-10

Schumacher

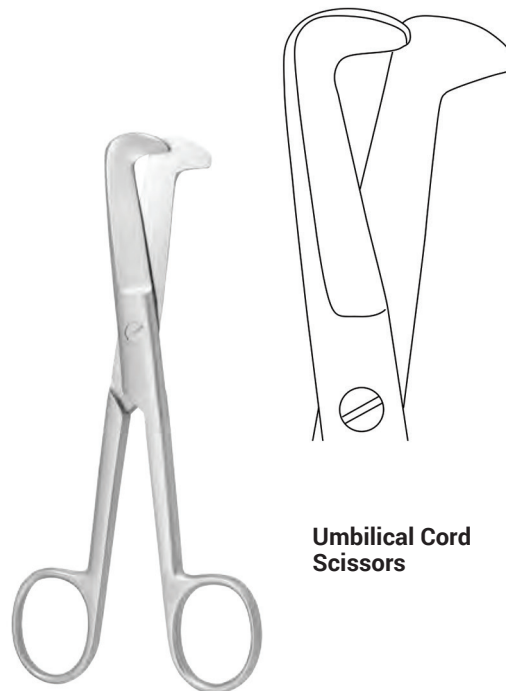

Umbilical Cord Scissors

Length	Code
16 cm	BB-0006-16

Bush



Umbilical Cord Scissors

Length	Code
13 cm	BB-0003-13
16 cm	BB-0003-16

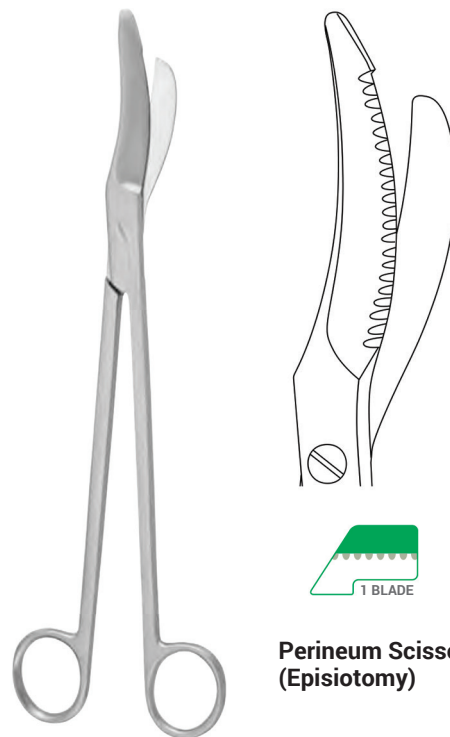

Perineum Scissors (Episiotomy)

Length	Code
24 cm	BB-0004-24



Bush



Length	Code
21 cm	BB-0005-21



Length	Code
21 cm	BB-0006-21



Length	Code
21 cm	BB-0007-21

Mayo

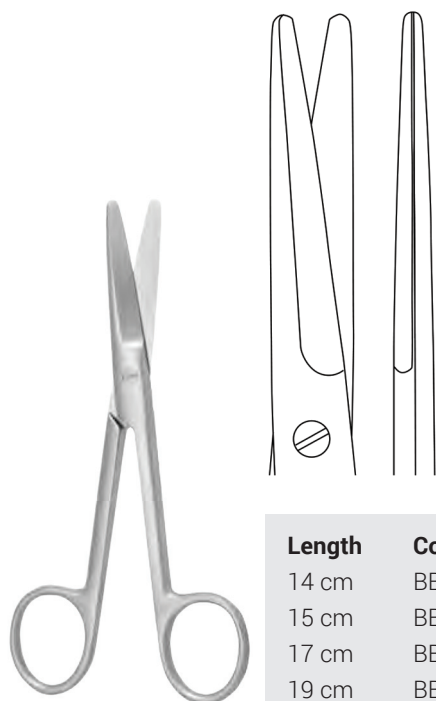

Length	Code
14 cm	BB-0366-14
15 cm	BB-0366-15
17 cm	BB-0366-17
19 cm	BB-0366-19
23 cm	BB-0366-23
30 cm	BB-0366-30

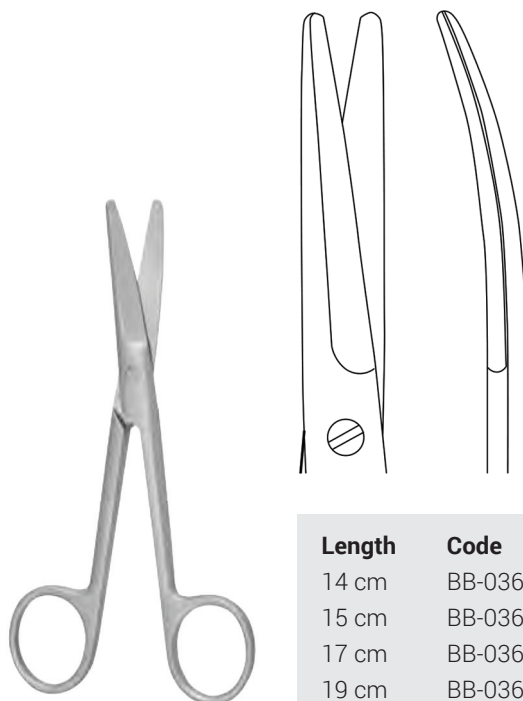

Length	Code
14 cm	BB-0369-14
15 cm	BB-0369-15
17 cm	BB-0369-17
19 cm	BB-0369-19
23 cm	BB-0369-23
30 cm	BB-0369-30



SCISSORS

Mayo-Stille

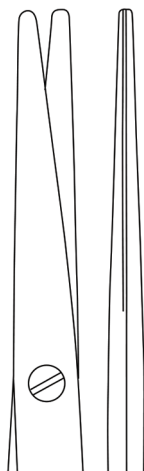

Length	Code
15 cm	BB-0360-15
17 cm	BB-0360-17
19 cm	BB-0360-19
21 cm	BB-0360-21
23 cm	BB-0360-23



Length	Code
15 cm	BB-0361-15
17 cm	BB-0361-17
19 cm	BB-0361-19
21 cm	BB-0361-21
23 cm	BB-0361-23

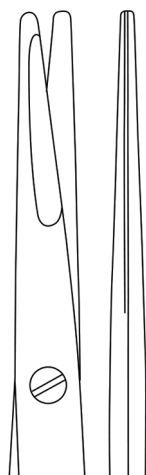

Chamfered Blades

Length	Code
14 cm	BB-0362-14
17 cm	BB-0362-17
19 cm	BB-0362-19
21 cm	BB-0362-21



Chamfered Blades

Length	Code
14 cm	BB-0363-14
17 cm	BB-0363-17
19 cm	BB-0363-19
21 cm	BB-0363-21



SCISSORS

Mayo-Harrington

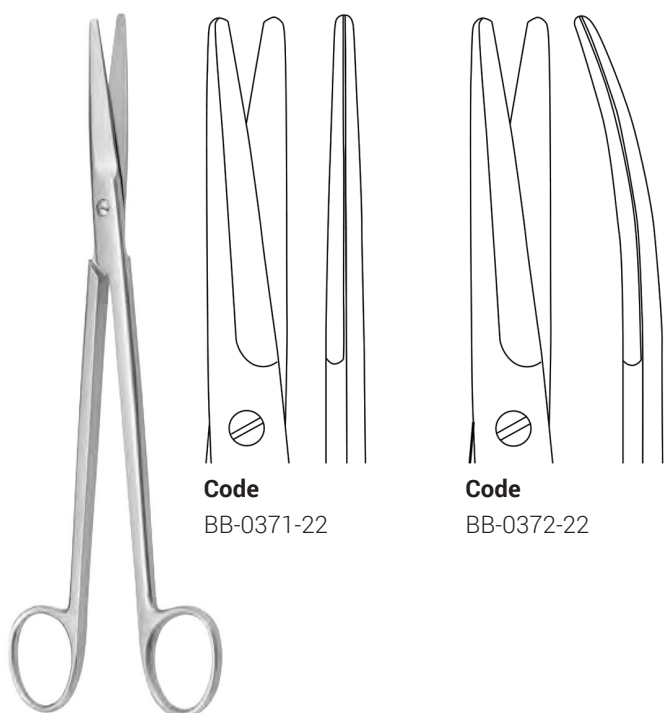

Code
BB-0371-22

Code
BB-0372-22

Length **Code**
22 cm BB-0371-22 - BB-0372-22

Mayo-Noble

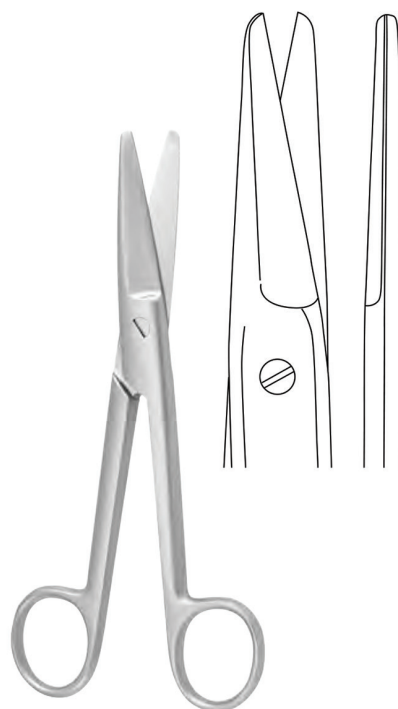

Length **Code**
17 cm BB-0972-17

Resano

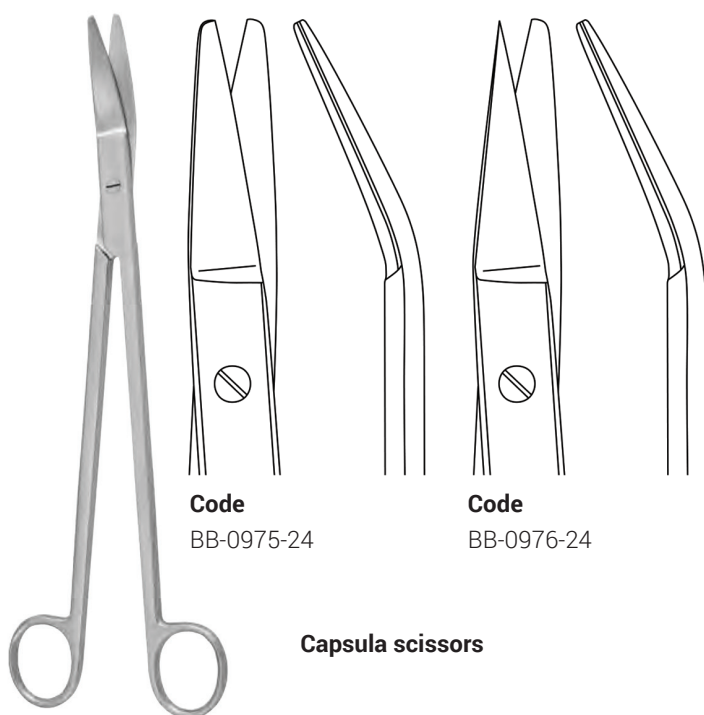

Code
BB-0975-24

Code
BB-0976-24

Capsula scissors

Length **Code**
24 cm BB-0975-24 - BB-0976-24

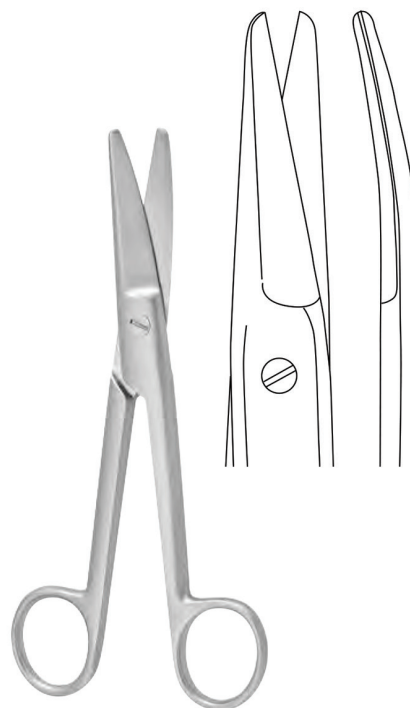

Length **Code**
17 cm BB-0974-17



SCISSORS

Lloyd-Davies



Length	Code
26 cm	BB-0958-26

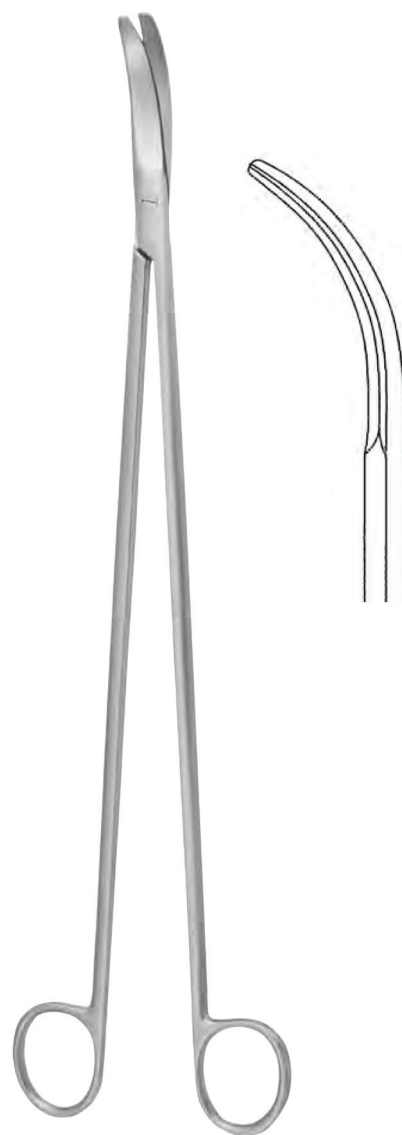

Length	Code
26 cm	BB-0959-26





SCISSORS

Stelzner



Code
BB-0952-31



Code
BB-0954-31

Length	Code
31 cm	BB-0952-31 - BB-0954-31

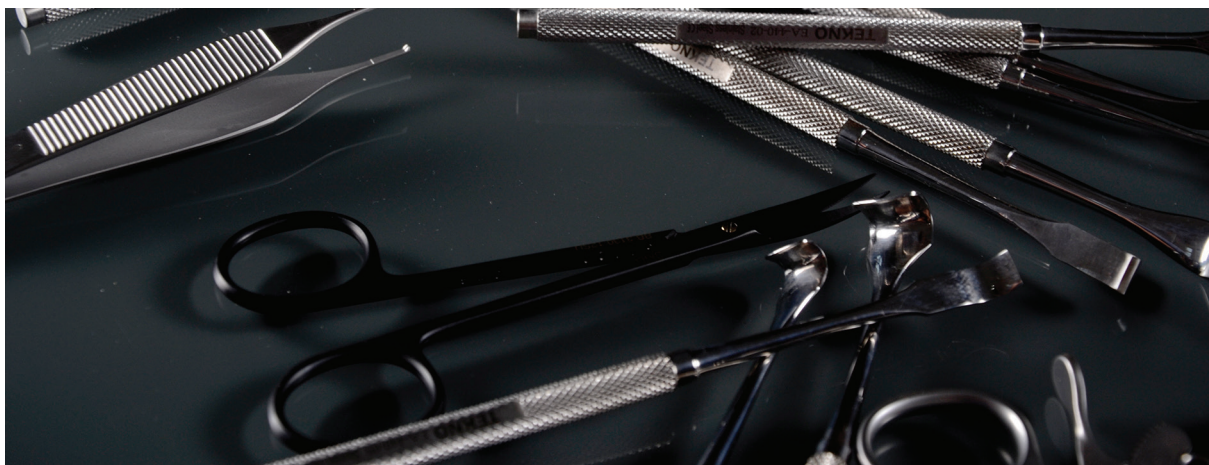



SCISSORS

Metzenbaum

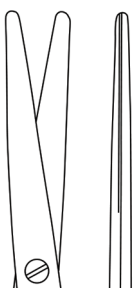

Length	Code
14 cm	BB-0200-14
18 cm	BB-0200-18
20 cm	BB-0200-20
23 cm	BB-0200-23
25 cm	BB-0200-25
28 cm	BB-0200-28
30 cm	BB-0200-30
36 cm	BB-0200-36



Length	Code
14 cm	BB-0201-14
18 cm	BB-0201-18
20 cm	BB-0201-20
23 cm	BB-0201-23
25 cm	BB-0201-25
28 cm	BB-0201-28
30 cm	BB-0201-30
36 cm	BB-0201-36

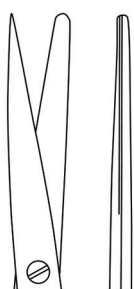

Length	Code
14 cm	BB-0182-14
18 cm	BB-0182-18
20 cm	BB-0182-20

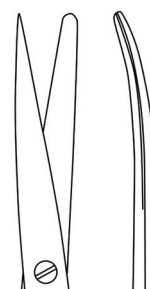

Length	Code
14 cm	BB-0183-14
18 cm	BB-0183-18
20 cm	BB-0183-20



Metzenbaum

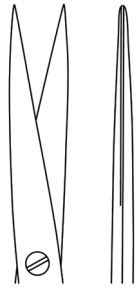

Length	Code
14 cm	BB-0185-14
18 cm	BB-0185-18
20 cm	BB-0185-20
23 cm	BB-0185-23

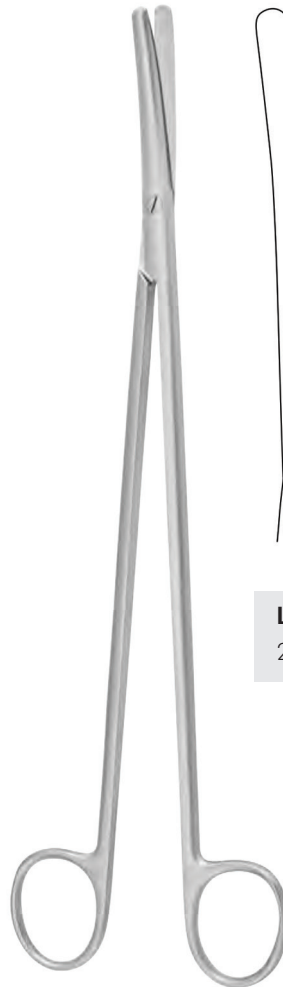

Length	Code
28 cm	BB-0220-28

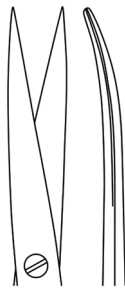

Length	Code
14 cm	BB-0182-14

SCISSORS

Metzenbaum-Fino

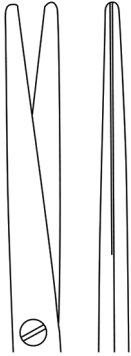

Length	Code
12 cm	BB-0197-12
14 cm	BB-0197-14
18 cm	BB-0197-18
20 cm	BB-0197-20
23 cm	BB-0197-23
25 cm	BB-0197-25



Length	Code
12 cm	BB-0198-12
14 cm	BB-0198-14
18 cm	BB-0198-18
20 cm	BB-0198-20
23 cm	BB-0198-23
25 cm	BB-0198-25
28 cm	BB-0198-28
30 cm	BB-0198-30

Lillehei-Potts

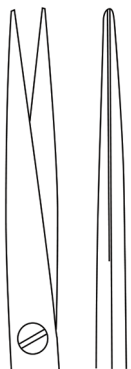
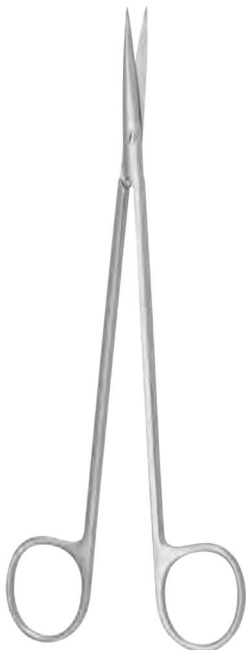

Length	Code
14 cm	BB-0239-14
18 cm	BB-0239-18
20 cm	BB-0239-20
23 cm	BB-0239-23

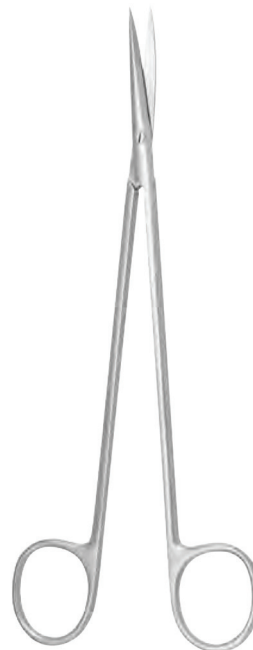

Length	Code
14 cm	BB-0240-14
18 cm	BB-0240-18
20 cm	BB-0240-20
23 cm	BB-0240-23



Metzenbaum-Fino-S



Length	Code
14 cm	BB-0172-14
18 cm	BB-0172-18
20 cm	BB-0172-20
23 cm	BB-0172-23
25 cm	BB-0172-25

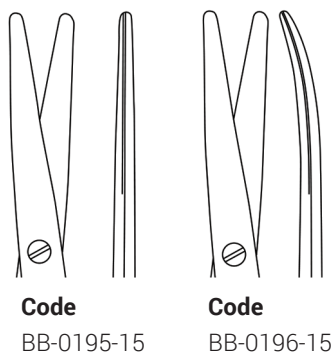

Code
BB-0195-15

Code
BB-0196-15

Short Blades

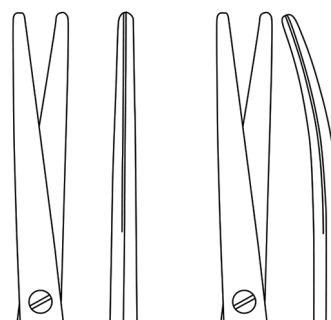

Code
BB-0197-11

Code
BB-0198-11

Length	Code
15 cm	BB-0195-15 - BB-0196-15

Length	Code
11 cm	BB-0197-11 - BB-0198-11

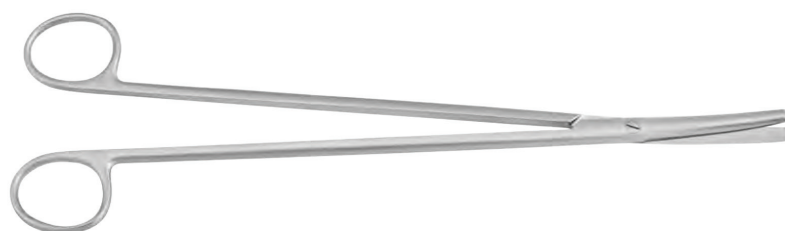

SCISSORS

Dissecting Scissors



Lexer

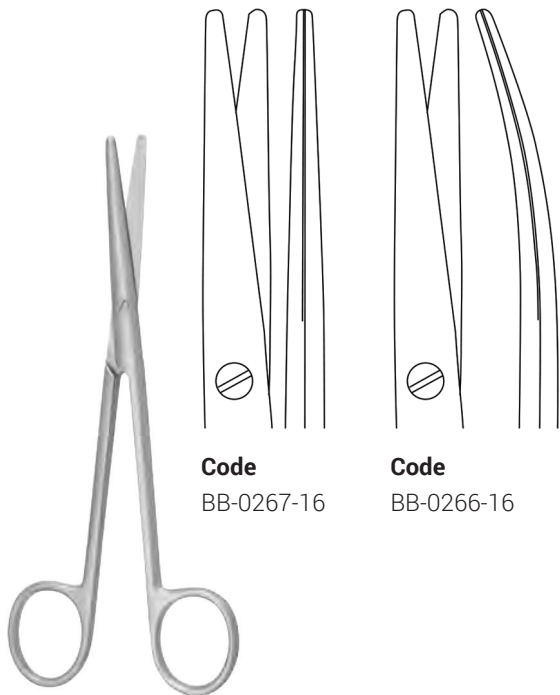

Code
BB-0267-16

Code
BB-0266-16

Length **Code**
16 cm BB-0267-16 - BB-0266-16

Lexer-Fino

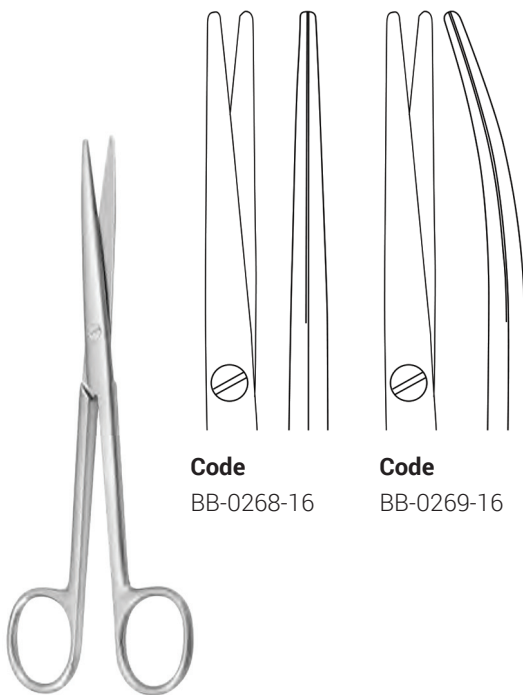

Code
BB-0268-16

Code
BB-0269-16

Length **Code**
16 cm BB-0268-16 - BB-0269-16

Lexer-Baby

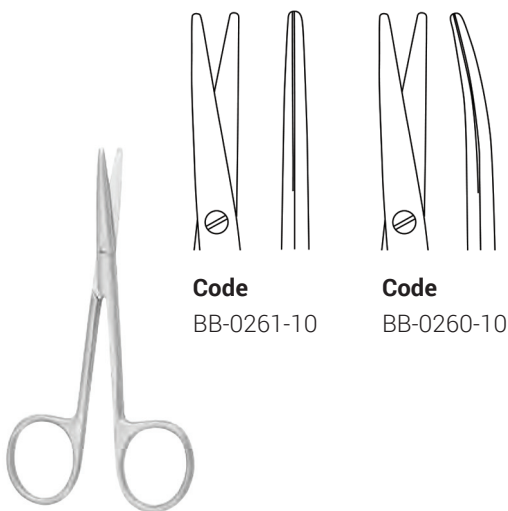

Code
BB-0261-10

Code
BB-0260-10

Length **Code**
10 cm BB-0261-10 - BB-0260-10

Starbismus

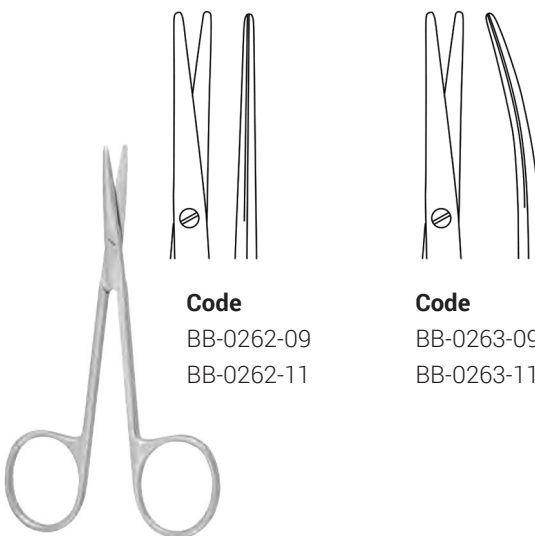

Code
BB-0262-09
BB-0262-11

Code
BB-0263-09
BB-0263-11

Length **Code**
09 cm BB-0262-09 - BB-0263-09
11 cm BB-0262-11 - BB-0263-11



Thorek



Length	Code
19 cm	BB-BB-0304--19
25 cm	BB-BB-0304--25

Gorney

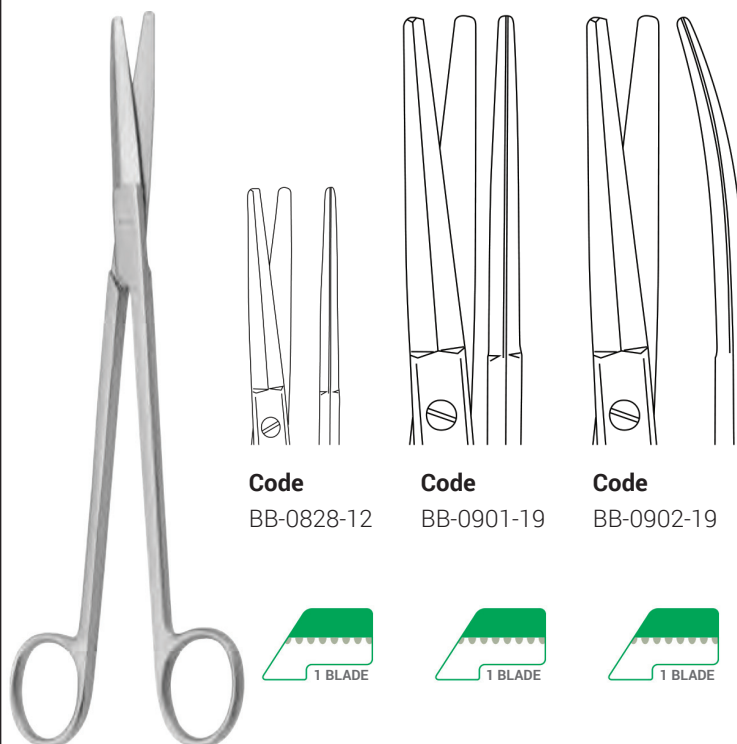

Length	Code
12 cm	BB-0828-12
19 cm	BB-0901-19 - BB-0902-19

Code
BB-0828-12

Code
BB-0901-19

Code
BB-0902-19



Kilner (Ragnell)



Length	Code
12 cm	BB-0299-12
14 cm	BB-0299-14

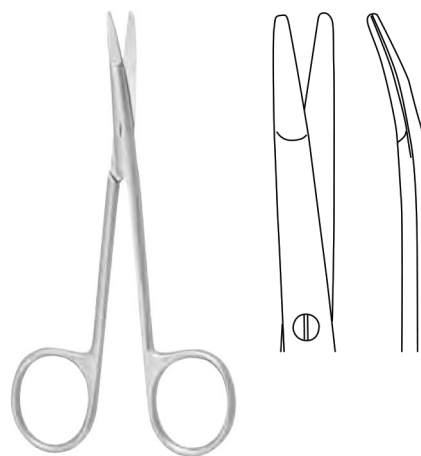

Length	Code
12 cm	BB-0300-12
14 cm	BB-0300-14
18 cm	BB-0300-18
20 cm	BB-0300-20

SCISSORS

Dissecting Scissors



Jameson



Code
BB-0312-13
BB-0312-15

Length	Code
13 cm	BB-0312-13
15 cm	BB-0312-15

Reynolds

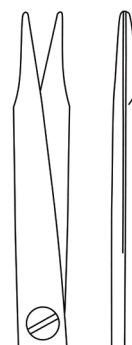

Code
BB-0313-13
BB-0313-15
BB-0313-18

Code
BB-0314-13
BB-0314-15
BB-0314-18

Length	Code
13 cm	BB-0313-13 - BB-0314-13
15 cm	BB-0313-15 - BB-0314-15
18 cm	BB-0313-18 - BB-0314-18

Toennis

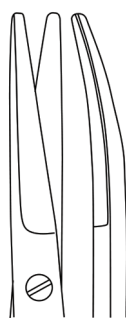
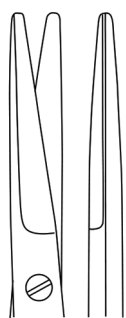
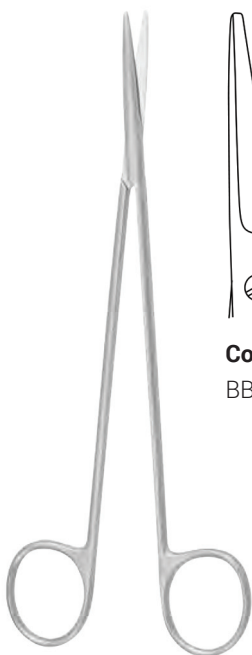

Code
BB-0294-18

Code
BB-0295-18

Length	Code
18 cm	BB-0294-18 - BB-0295-18

Toennis-Fino



Length	Code
18 cm	BB-0296-18



SCISSORS

Toennis-Adson



Code
BB-0297-17



Code
BB-0298-17

Dissecting Scissors

Length 17 cm
Code BB-0297-17 - BB-0298-17

DeBakey



Code
BB-0299-17

Dissecting Scissors

Length 17 cm
Code BB-0299-17

Aufricht

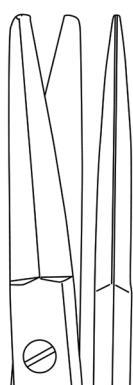

Code
BB-0898-15

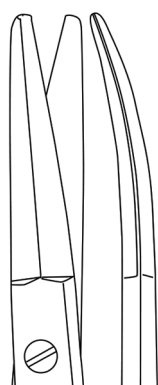

Code
BB-0899-15

Plastic Surgery Scissors

Length 15 cm
Code BB-0898-15 - BB-0899-15

McIndoe

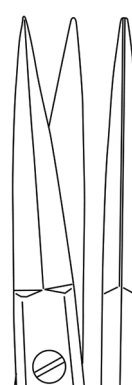
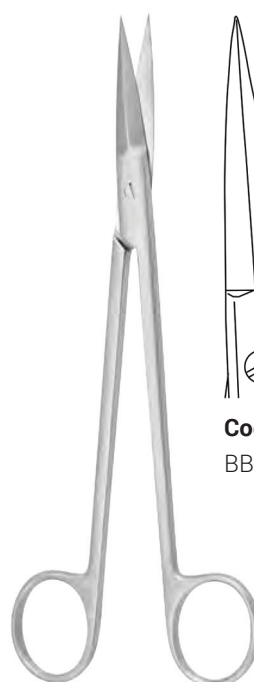

Code
BB-0900-19

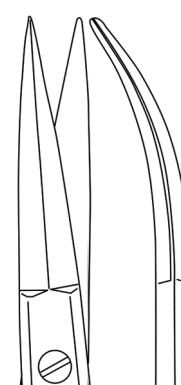

Code
BB-0901-19

Cartilage Scissors

Length 19 cm
Code BB-0900-19 - BB-0901-19

SCISSORS

Tonsil Scissors, Cartilage Scissors



Boettcher

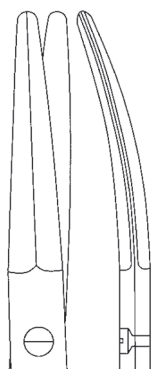

Tonsil Scissors

Length 18 cm
Code BB-0245-18

Martin

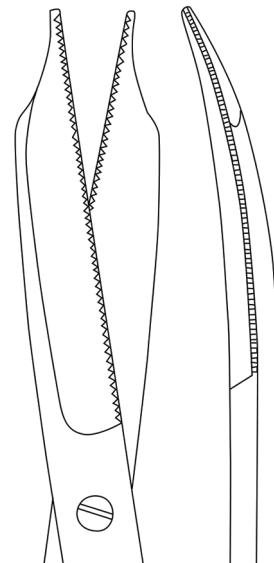

Cartilage Scissors

Length 20 cm
Code BB-0307-18



Prince

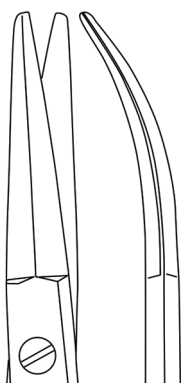

Tonsil Scissors

Length 17 cm
Code BB-0246-17

Dean

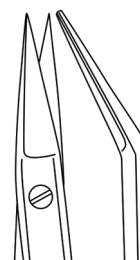

Code
BB-0250-17

Code
BB-0251-17

Tonsil Scissors

Length 17 cm
Code BB-0250-17 - BB-0251-17





Good

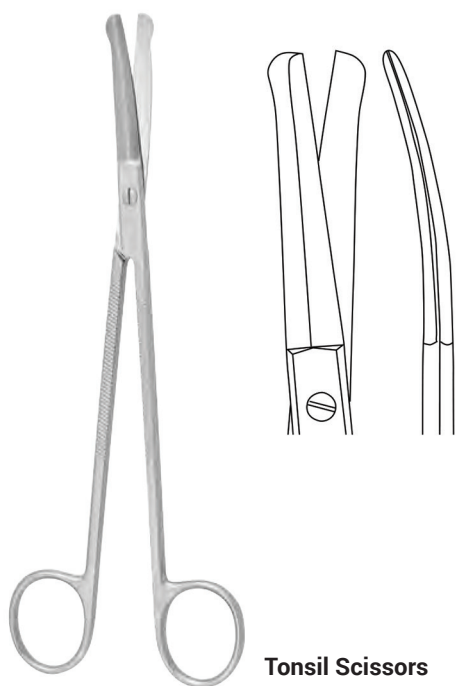

Tonsil Scissors

Length	Code
19 cm	BB-0248-19

Good-Schwekendieck

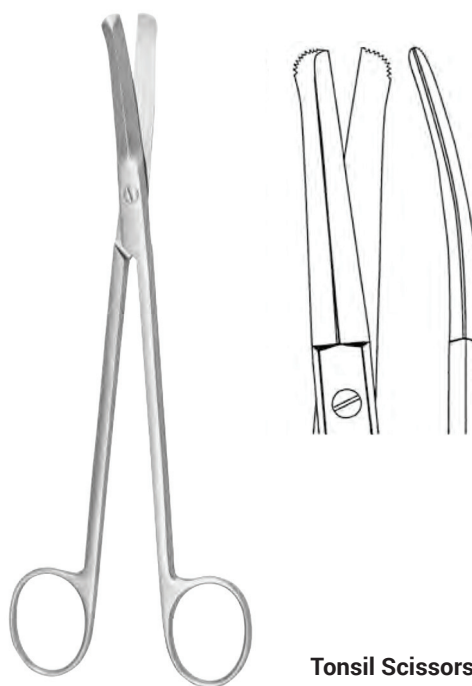

Tonsil Scissors

Length	Code
19 cm	BB-0249-19

Potts-Smith

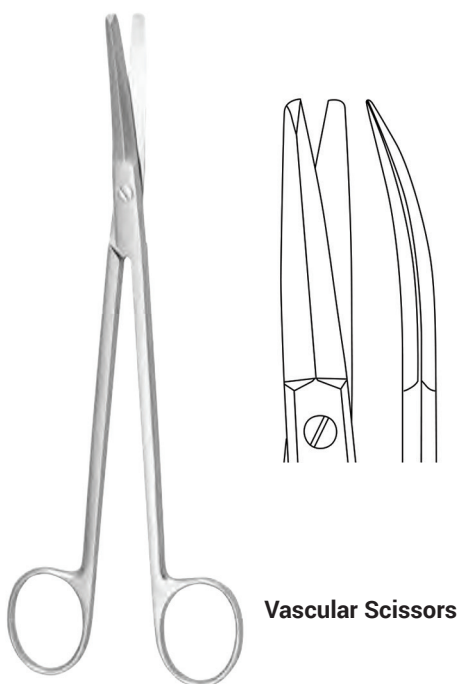

Vascular Scissors

Length	Code
19 cm	BB-0293-19

Kahn

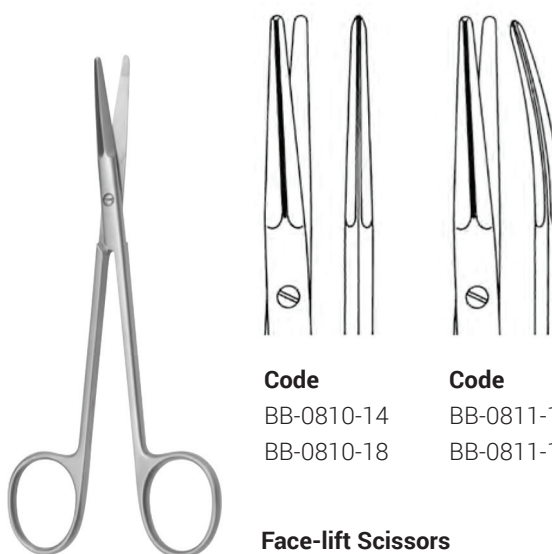

Code	Code
BB-0810-14	BB-0811-14
BB-0810-18	BB-0811-18

Face-lift Scissors

Length	Code
14 cm	BB-0810-14 - BB-0811-14
18 cm	BB-0810-18 - BB-0811-18



Salyer



Face-lift Scissors

Length 9 cm
Code BB-0864-09



Face-lift Scissors

Length 10 cm
Code BB-0865-10

Kaye



Face-lift Scissors

Length 11 cm
Code BB-0866-11

Fomon



Nasal Scissors

Length 13 cm
Code BB-0946-13

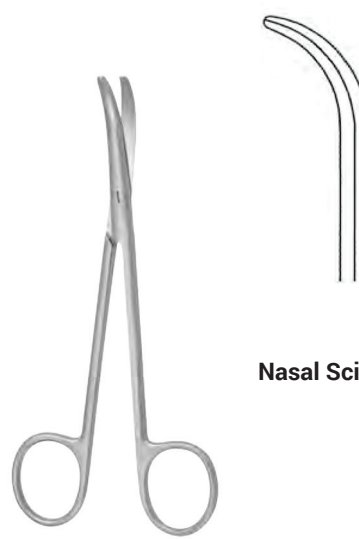

Nasal Scissors

Length 13 cm
Code BB-0947-13

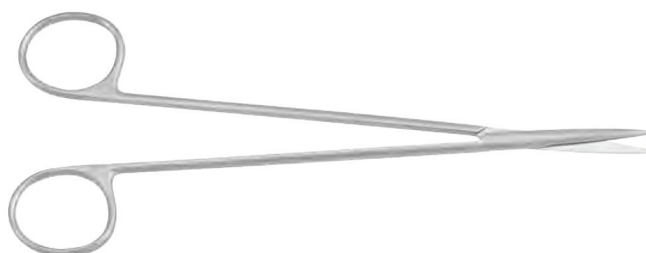



SCISSORS

Fomon-Fino

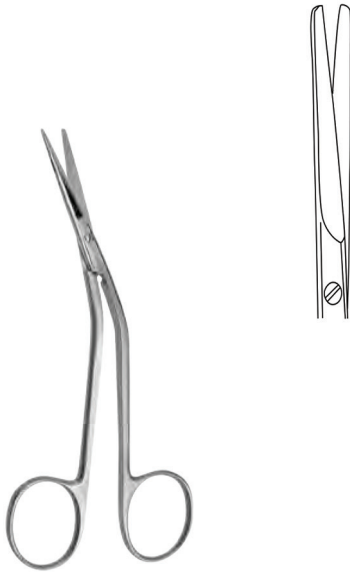

Length	Code
13 cm	BB-0236-13

Fomon

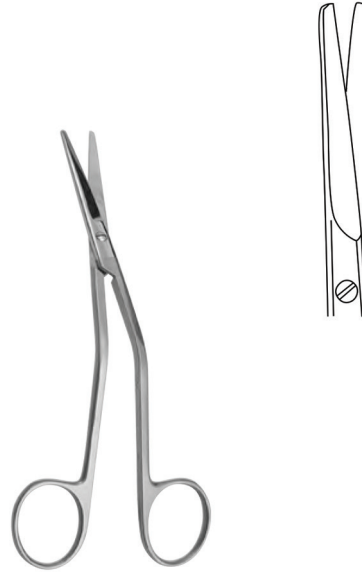

Length	Code
14 cm	BB-0327-14

Fomon

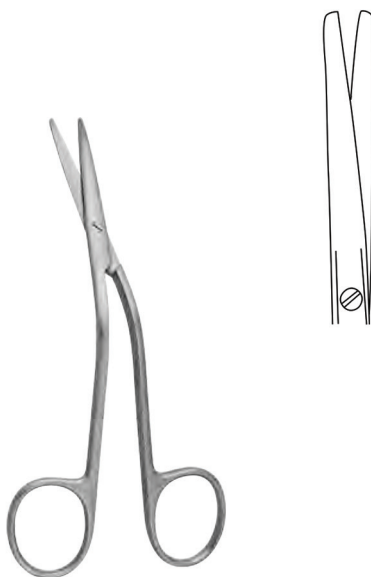

Length	Code
13 cm	BB-0328-13

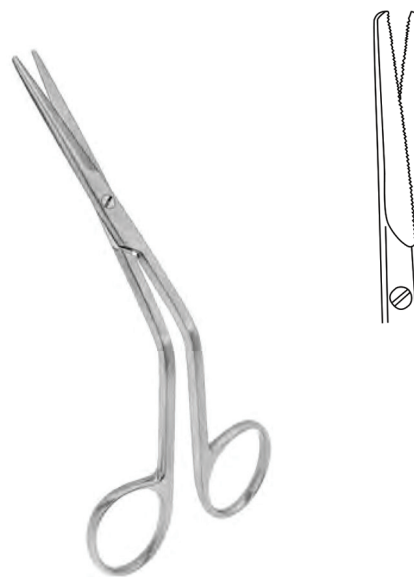

Length	Code
15 cm	BB-0329-15

SCISSORS

Nasal Scissors 

Cottle



Length	Code
16 cm	BB-0328-16

Heymann



Length	Code
17cm	BB-0320-17
18 cm	BB-0320-18
20 cm	BB-0320-20

Heymann

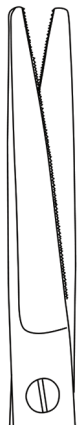
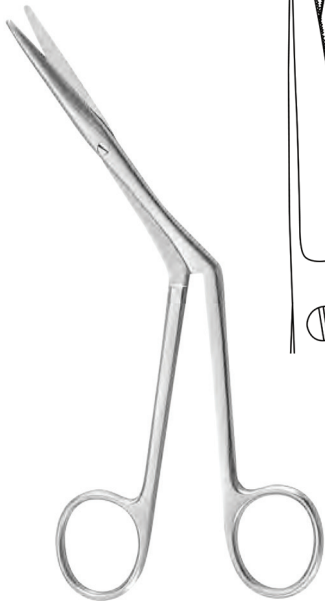

Length	Code
18 cm	BB-0321-18

Olivecrona



Length	Code
23 cm	BB-0323-23



SCISSORS

Tessier

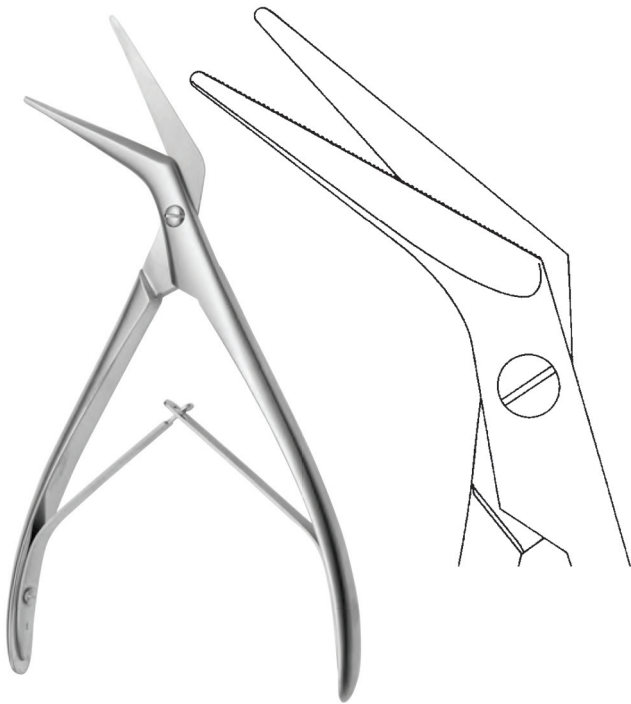

Length	Code
20 cm	BB-0305-20

Knight



Length	Code
18 cm	BB-0306-18

Fomon



Length	Code
11 cm	BB-0945-11

Landolt



Code
BB-0307-11

Code
BB-0307-12

Length	Code
11 cm	BB-0307-11
12 cm	BB-0307-12



Cottle-Masing



Code
BB-0651-11

Code
BB-0652-11

Length **Code**
10 cm BB-0650-10

Length **Code**
11 cm BB-0651-11 - BB-0652-11

Cottle

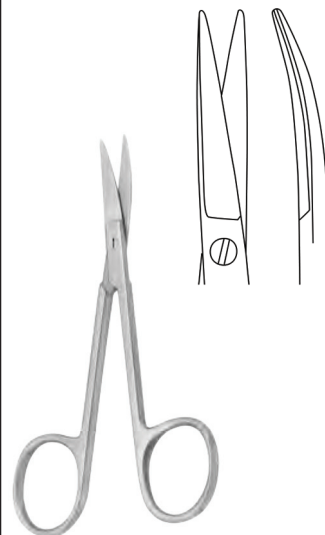

Length **Code**
12cm BB-0653-12

Cottle-Knapp

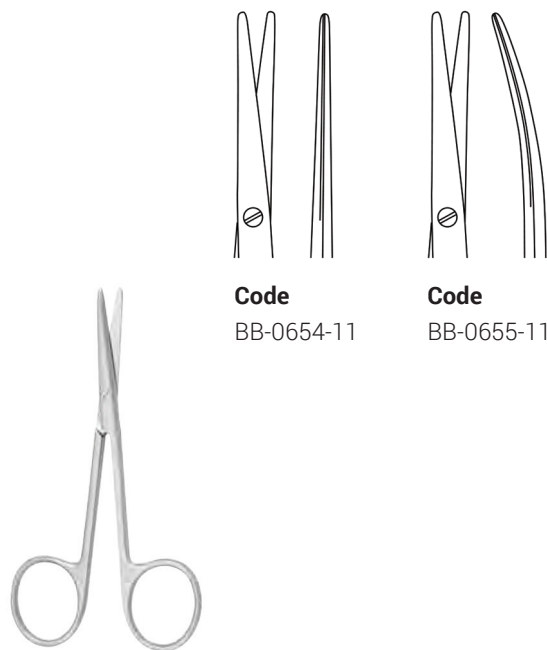

Code
BB-0654-11

Code
BB-0655-11

Length **Code**
11 cm BB-0654-11 - BB-0655-11

Wilmer-Walter

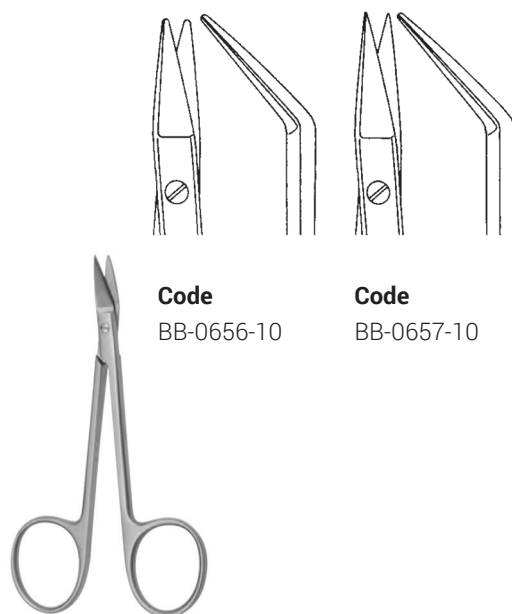

Code
BB-0656-10

Code
BB-0657-10

Length **Code**
10 cm BB-0656-10 - BB-0657-10

Delicate Surgical Scissors



SCISSORS

Kelly

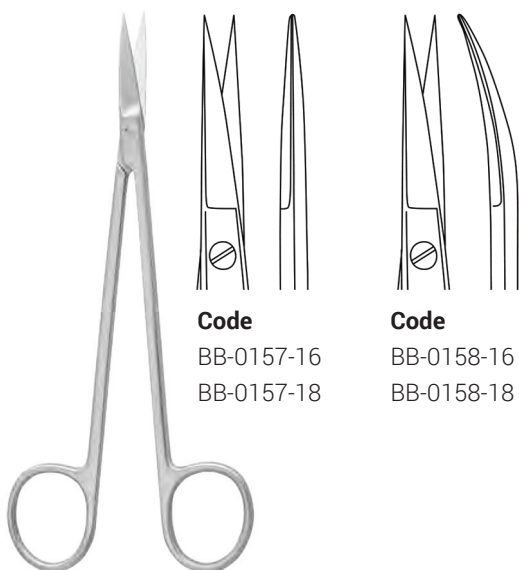

Code

BB-0157-16
BB-0157-18

Code

BB-0158-16
BB-0158-18

Length

16 cm
18 cm

Code

BB-0157-16 - BB-0158-16
BB-0157-18 - BB-0158-18

Joseph

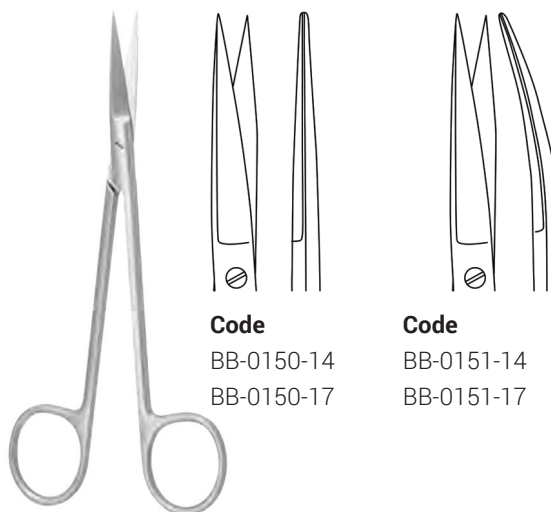

Code

BB-0150-14
BB-0150-17

Code

BB-0151-14
BB-0151-17

Length

14 cm
17 cm

Code

BB-0150-14 - BB-0151-14
BB-0150-17 - BB-0151-17

Peck-Joseph

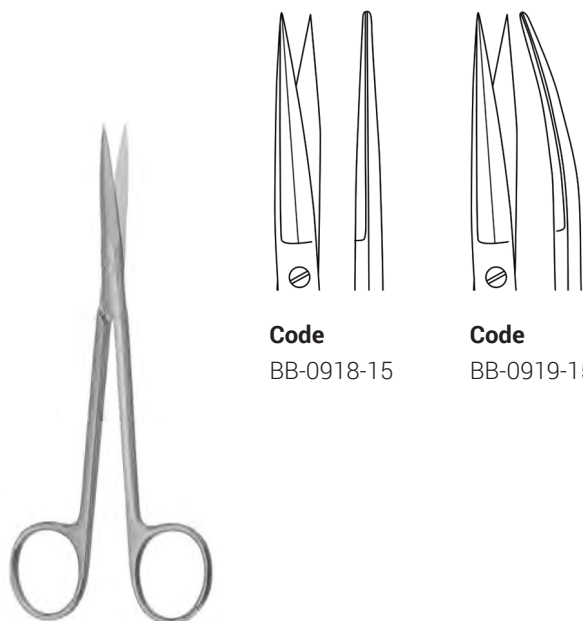

Code

BB-0918-15

Code

BB-0919-15

Length

15 cm

Code

BB-0918-15 - BB-0919-15

Chadwick



Length

11 cm

Code

BB-0539-11

SCISSORS

Delicate Surgical Scissors



Quinby



Code
BB-0525-13



Code
BB-0526-13

Gum Scissors

Length	Code
13 cm	BB-0525-13 - BB-0526-13

Sanvenero



Code
BB-0148-14



Code
BB-0149-14

Length	Code
14 cm	BB-0148-14 - BB-0149-14

Sanvenero

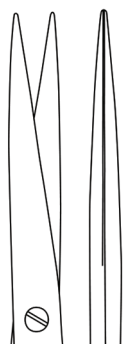
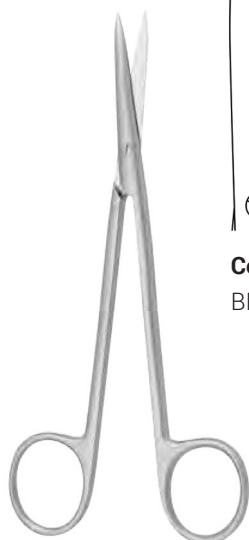

Code
BB-0660-15



Code
BB-0661-15

Length	Code
15 cm	BB-0660-15 - BB-0661-15

La Grange

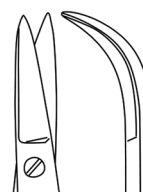

Gum Scissors

Length	Code
11 cm	BB-0540-11

Delicate Surgical Scissors



SCISSORS

Goldmann-Fox

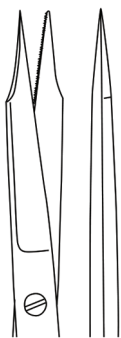

Code
BB-0520-13



Gum Scissors



Code
BB-0521-13



Length 13 cm
Code BB-0520-13 - BB-0521-13

Goldmann-Fox-S

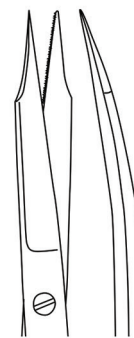

Gum Scissors

Length 12 cm
Code BB-0522-12



Goldmann-Fox



Code
BB-0523-11



Code
BB-0524-11

Length 11 cm
Code BB-0523-11 - BB-0524-11

Wagner



Code
BB-0750-12



Code
BB-0751-12

Flat Screw Lock

Length 12 cm
Code BB-0750-12 - BB-0751-12



Wagner-Standard



Fig. 1

Code
BB-0751-12



Fig. 1

Code
BB-0752-12



Fig. 2

Code
BB-0753-12



Fig. 2

Code
BB-0754-12

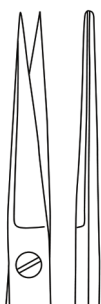

Fig. 3

Code
BB-0755-12



Fig. 3

Code
BB-0756-12

Length	Code
12 cm	BB-0751-12 - BB-0752-12 - BB-0753-12 - BB-0754-12 - BB-0755-12 - BB-0756-12

Kilner



Code
BB-0303-11



Code
BB-0304-11

Length	Code
11 cm	BB-0303-11 - BB-0304-11

Littler



Code
BB-0854-12
BB-0854-14

Length	Code
12 cm	BB-0854-12
14 cm	BB-0854-14



Stevens Tenotomy

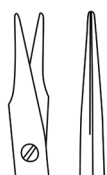

Fig. 1

Code

BB-0167-12
BB-0167-13
BB-0167-18



Fig. 1

Code

BB-0168-12
BB-0168-13
BB-0168-18

Length

Code

12 cm	BB-0167-12 - BB-0168-12
13 cm	BB-0167-13 - BB-0168-13
18 cm	BB-0167-18 - BB-0168-18

Iris

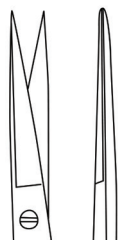

Length

Code

09 cm	BB-0110-09
10 cm	BB-0110-10
11 cm	BB-0110-11

Length

Code

09 cm	BB-0111-09
10 cm	BB-0111-10
11 cm	BB-0111-11



SCISSORS

Delicate Surgical Scissors



Iris



Code
BB-0113-11



Code
BB-0112-11

Length	Code
11 cm	BB-0113-11 - BB-0112-11

O'Brien



Length	Code
09 cm	BB-1206-09

Iris Standard

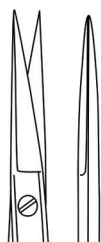

Length	Code
09 cm	BB-0125-09
10 cm	BB-0125-10
11 cm	BB-0125-11
12 cm	BB-0125-12



Length	Code
09 cm	BB-0126-09
10 cm	BB-0126-10
11 cm	BB-0126-11
12 cm	BB-0126-12

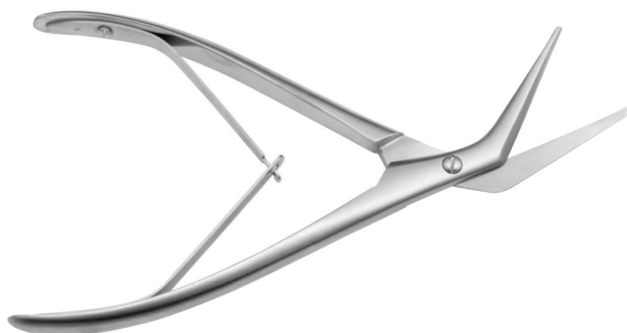

Delicate Surgical Scissors



SCISSORS

Iris-Fino

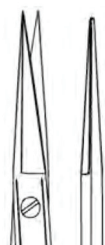
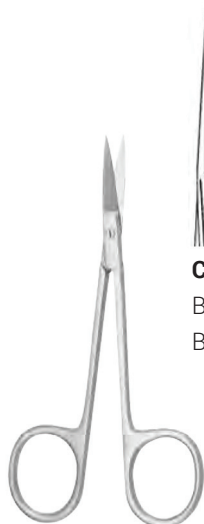

Code
BB-0127-10
BB-0127-11

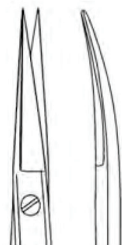

Code
BB-0128-10
BB-0128-11

Length	Code
10 cm	BB-0127-10 - BB-0128-10
11 cm	BB-0127-11 - BB-0128-11

Iris-Anatomy



Code
BB-0129-11



Code
BB-0130-11

Length	Code
11 cm	BB-0129-11 - BB-0130-11

Bonn



Code
BB-0131-08
BB-0131-09



Code
BB-0132-08
BB-0132-09

Length	Code
08 cm	BB-0131-08 - BB-0132-08
09 cm	BB-0131-09 - BB-0132-09

Graefe

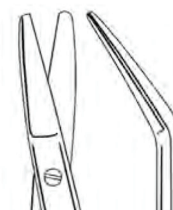

Length	Code
10 cm	BB-0133-10

Ribbon-Stevens Tenotomy



Code
BB-0164-10



Code
BB-0165-10

Length	Code
10 cm	BB-0164-10 - BB-0165-10

Ribbon-Iris



Code
BB-0141-10



Code
BB-0142-10



Code
BB-0143-10



Code
BB-0144-10

Length	Code
10 cm	BB-0141-10 - BB-0142-10 - BB-0143-10 - BB-0144-10

Jabaley



Code
BB-0145-13



Code
BB-0146-13

Length	Code
13 cm	BB-0145-13 - BB-0146-13



SCISSORS

Satinsky



Length	Code
24 cm	BB-0306-24

Bozemann



Length	Code
23 cm	BB-0307-23

Klinkenbergh-Loth

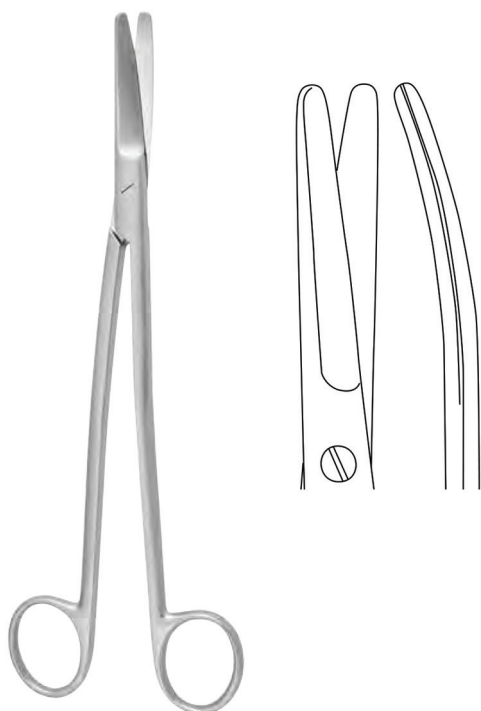

Length	Code
23 cm	BB-0308-23

Strully

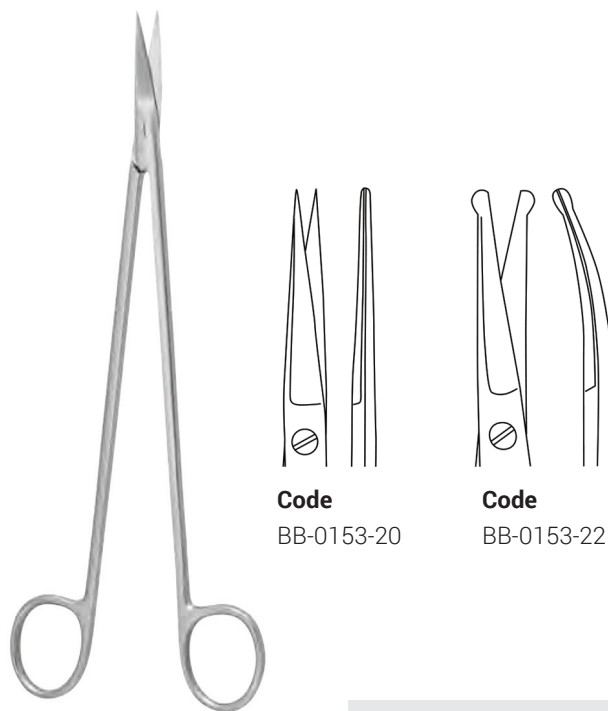

Code
BB-0153-20

Code
BB-0153-22

Length	Code
20 cm	BB-0153-20
22 cm	BB-0153-22



SCISSORS

Church

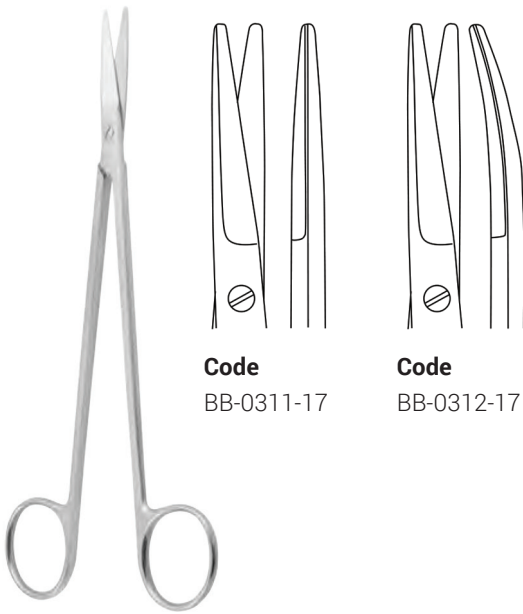

Code
BB-0311-17

Code
BB-0312-17

Length **Code**
17 cm BB-0311-17 - BB-0312-17

Jorgenson

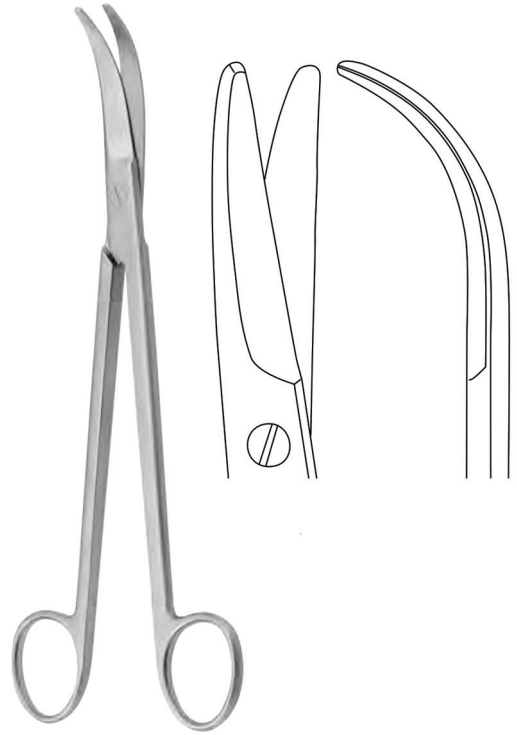

Length **Code**
23 cm BB-0313-23

Dandy

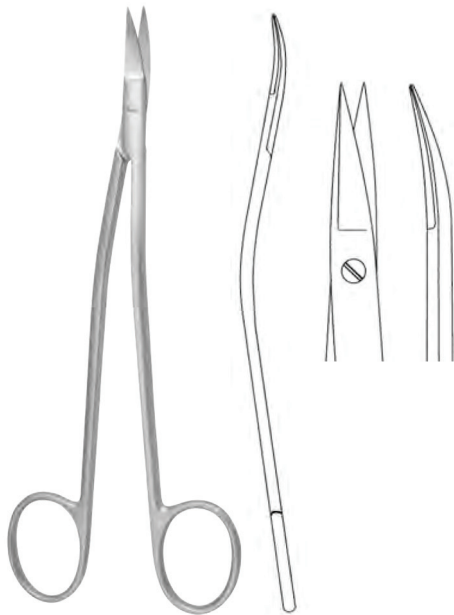

Length **Code**
17 cm BB-0297-17

Classon



Length **Code**
17 cm BB-0295-17



SCISSORS

Potts-Smith

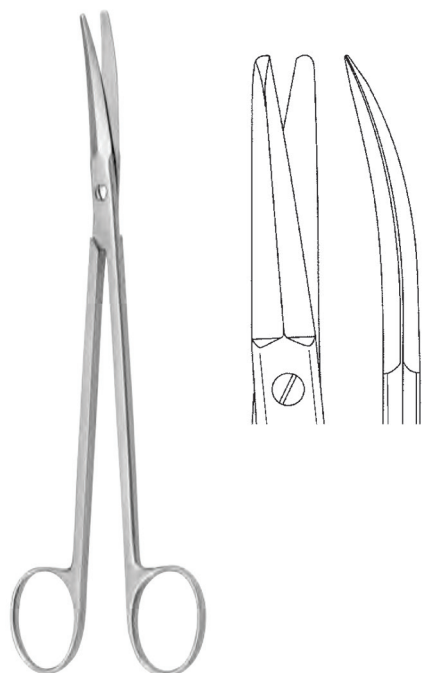

Length	Code
19 cm	BB-0293-19

Locklin

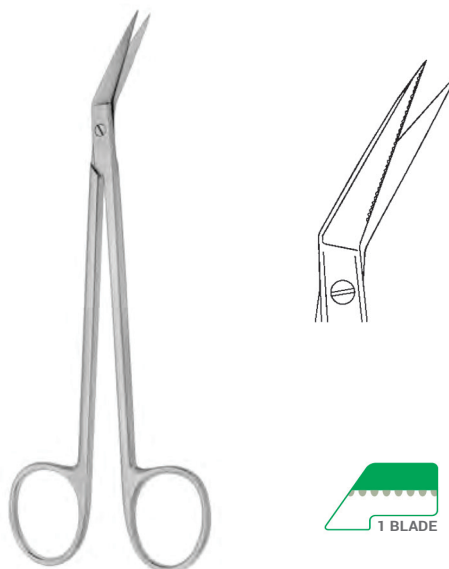

Length	Code
16 cm	BB-0534-16

Locklin

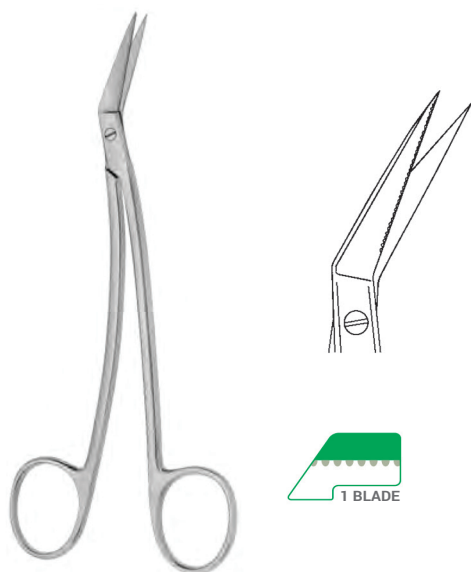

Length	Code
16 cm	BB-0536-16

Schmieden-Taylor



Length	Code
14 cm	BB-0290-14
17 cm	BB-0290-17



SCISSORS

DeBakey

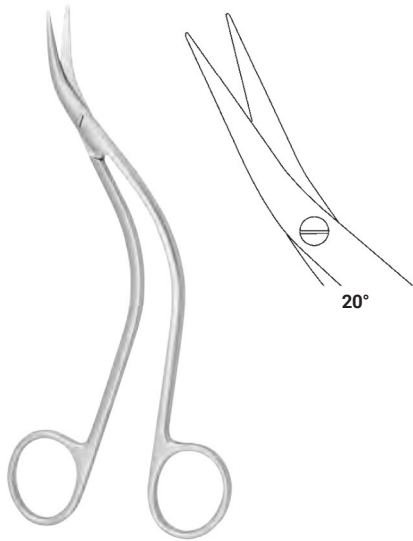

Length	Code
15 cm	BB-0996-15

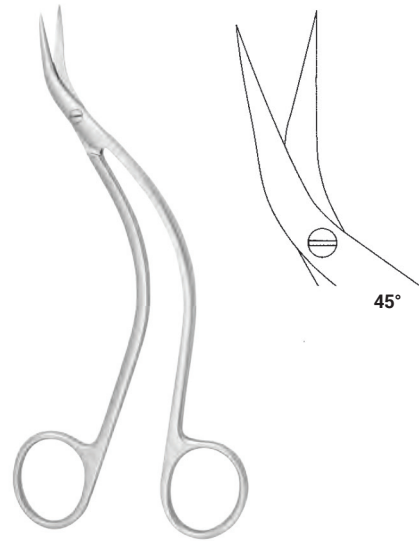

Length	Code
16 cm	BB-0998-16

DeBakey

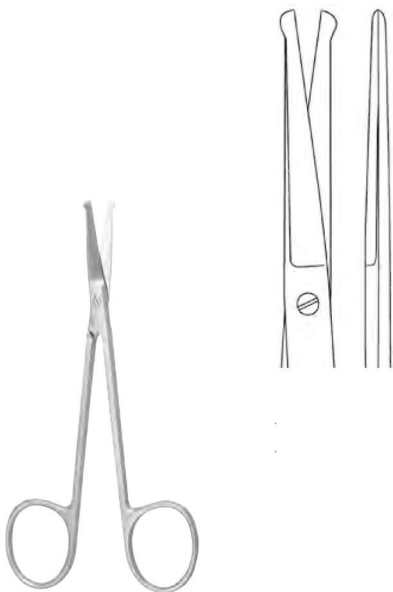

Length	Code
10 cm	BB-0001-10
11 cm	BB-0001-11

Favaloro

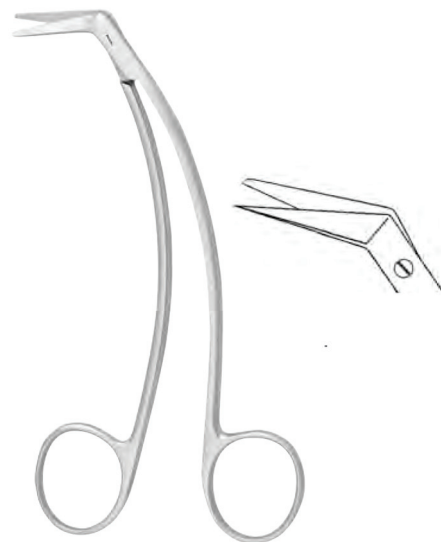

Length	Code
15 cm	BB-0002-15



Favaloro

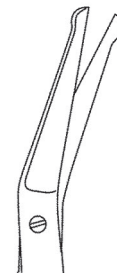

Length **Code**
11 cm BB-0003-11

Length **Code**
11 cm BB-0004-11

Favaloro



Length **Code**
14 cm BB-0004-14

DeBakey

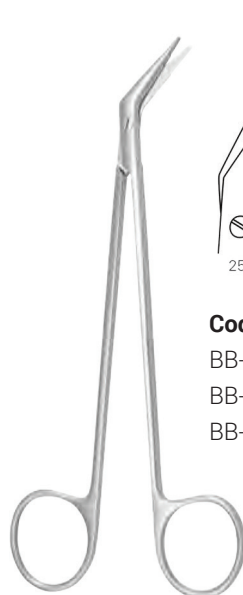

Code
BB-0410-16
BB-0410-19
BB-0410-23

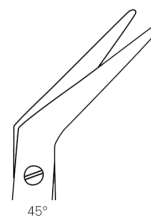

Code
BB-0420-16
BB-0420-19
BB-0420-23

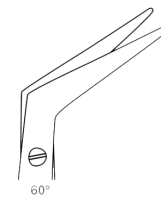

Code
BB-11-0430-16
BB-11-0430-19
BB-11-0430-23

Length **Code**
16 cm BB-0410-16 - BB-0420-16 - BB-11-0430-16
19 cm BB-0410-19 - BB-0420-19 - BB-11-0430-19
23 cm BB-0410-23 - BB-0420-23 - BB-11-0430-23

SCISSORS

Potts-Smith



Code
BB-0154-19

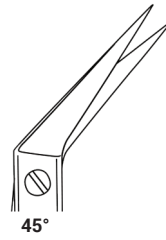

Code
BB-0155-19

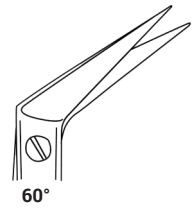

Code
BB-0156-19



Code
BB-0154-19B

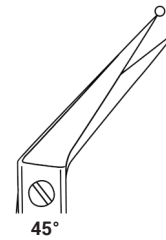

Code
BB-0155-19B

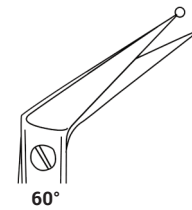

Code
BB-0156-19B

Length	Code
18 cm	BB-0154-19 - BB-0155-19 - BB-0156-19 - BB-0154-19B - BB-0155-19B - BB-0156-19B

Potts-Smith

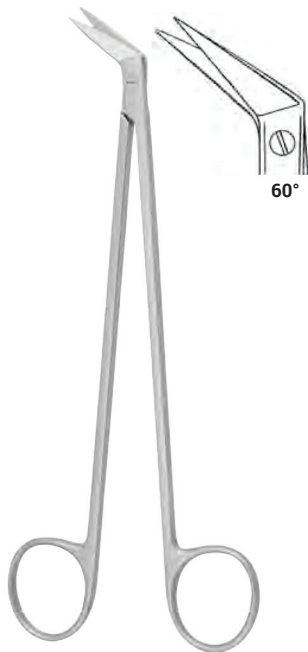

60°

Length	Code
18 cm	BB-0158-18

Potts-De Martel

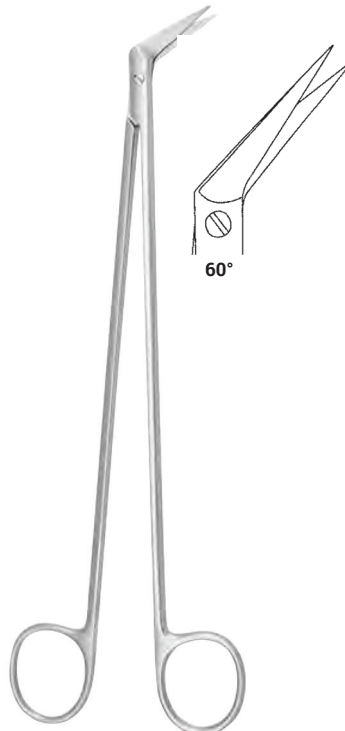

60°

Length	Code
22 cm	BB-0159-22

Potts-Smith

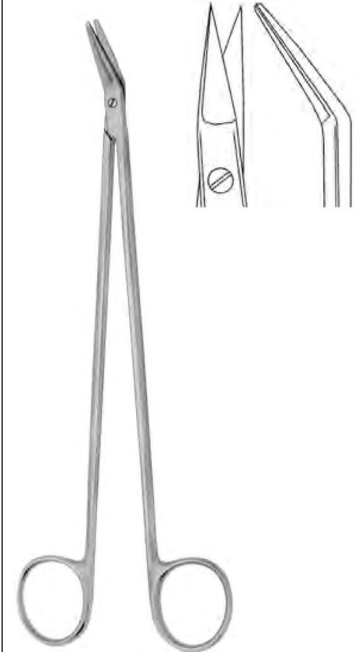

Length	Code
18 cm	BB-0160-18

Vascular Scissors



SCISSORS

Mills

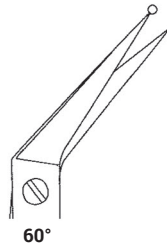
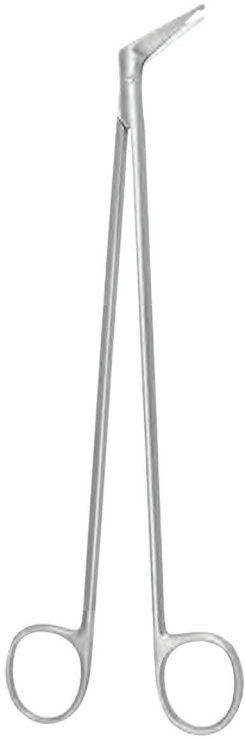

60°

Length 22 cm
Code BB-0161-22

Dietrich-Hegemann

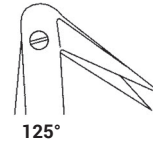

125°

Dietrich-Hegemann available in petite point paediatric blades

Length 19 cm
Code BB-0162-19

Dietrich-Hegemann

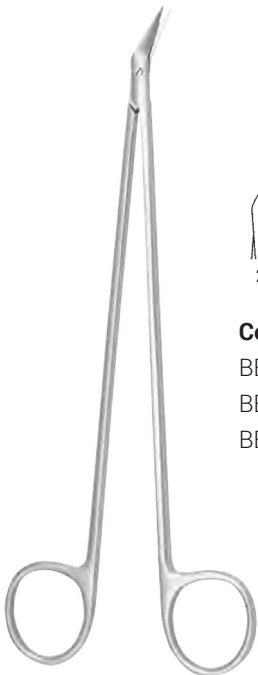

25°

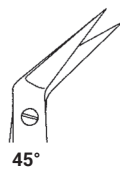

45°

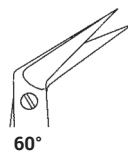

60°

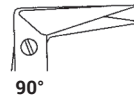

90°

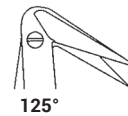

125°

Code
BB-0400-13
BB-0400-16
BB-0400-19

Code
BB-0401-13
BB-0401-16
BB-0401-19

Code
BB-0402-13
BB-0402-16
BB-0402-19

Code
BB-0403-13
BB-0403-16
BB-0403-19

Code
BB-0404-13
BB-0404-16
BB-0404-19

Dietrich-Hegemann available in petite point paediatric blades

Length 13 cm BB-0400-13 - BB-0401-13 - BB-0402-13 - BB-0403-13 - BB-0404-13
16 cm BB-0400-16 - BB-0401-16 - BB-0402-16 - BB-0403-16 - BB-0404-16
19 cm BB-0400-19 - BB-0401-19 - BB-0402-19 - BB-0403-19 - BB-0404-19

SCISSORS

Spencer-Fino



Length	Code
11 cm	BB-0276-11

Spencer



Length	Code
09 cm	BB-0278-09
11 cm	BB-0278-11
13 cm	BB-0278-13



Length	Code
11 cm	BB-0281-11

Shortbrent



Length	Code
09 cm	BB-0279-09

Locklin



Length	Code
15 cm	BB-0532-15

Northbent



Length	Code
13 cm	BB-0276-13

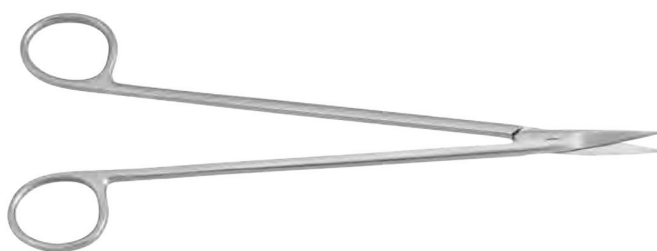

Ligature Scissors



SCISSORS

Littauer



Length	Code
14 cm	BB-0285-14

Littler

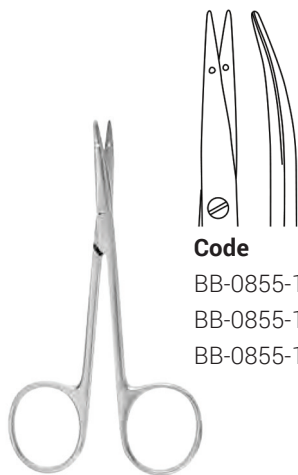

Code
 BB-0855-11
 BB-0855-14
 BB-0855-18

Length	Code
11 cm	BB-0855-11
14 cm	BB-0855-14
18 cm	BB-0855-18

Buck

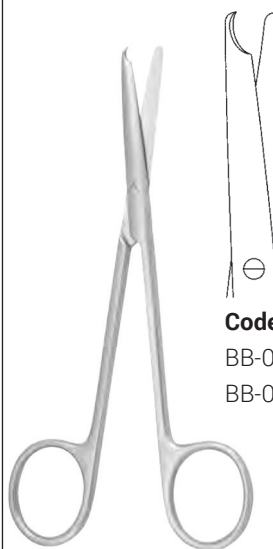

Code
 BB-0282-14
 BB-0282-18

Length	Code
14 cm	BB-0282-14
18 cm	BB-0282-18

Eiselsberg



Length	Code
12 cm	BB-0286-12

Heath

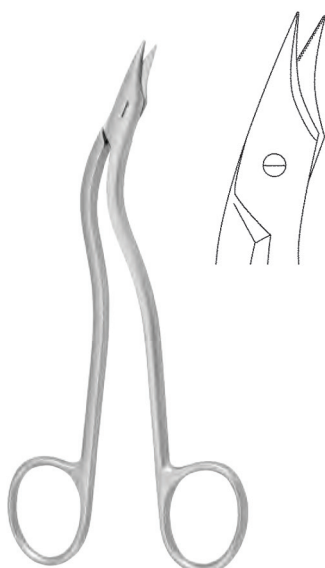

Length	Code
15 cm	BB-0287-15

Schoemaker-Loth



Length	Code
12 cm	BB-0288-12



Beebee

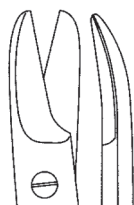

Code
BB-0701-10



Code
BB-0702-10

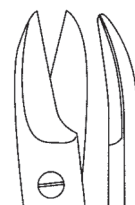

Code
BB-0703-10

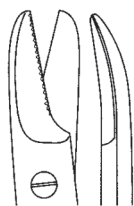

Code
BB-0704-12

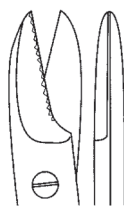

Code
BB-0705-12

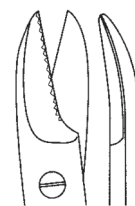

Code
BB-0706-12



Length	Code
10 cm	BB-0701-10 - BB-0702-10 - BB-0703-10
12 cm	BB-0704-12 - BB-0705-12 - BB-0706-12

Guilford-Wright



Length	Code
12 cm	BB-0545-12

Universal



Length	Code
12 cm	BB-0546-12

Harvey

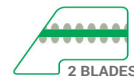
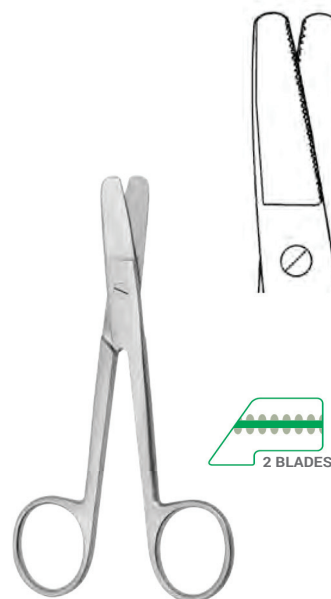

Length	Code
12 cm	BB-0547-12

Supercut Scissors

- SUPERCUT Scissors have one razor blade which allows an easy and clean cut.
- The micro serration at the opposite blade prevents sliding off the tissue.

Characteristic: Golden Screw



Cutting Geometry

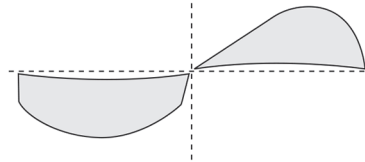



SCISSORS

Standard

Fig. 2

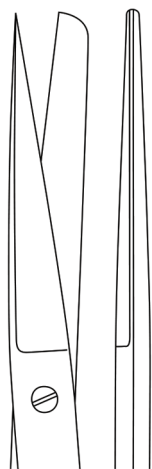

Surgical Scissors

Length	Code
13 cm	BB-3608-13
14 cm	BB-3608-14



Fig. 2



Surgical Scissors

Length	Code
13 cm	BB-3609-13
14 cm	BB-3609-14



Sims



Uterine Scissors

Length	Code
20 cm	BB-3500-20 - BB-3509-20
23 cm	BB-3500-23 - BB-3509-23

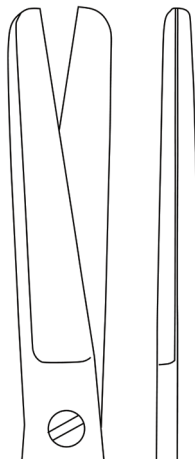

Code
BB-3500-20
BB-3500-23



Code
BB-3509-20
BB-3509-23





SCISSORS

Sims-Siebold-S

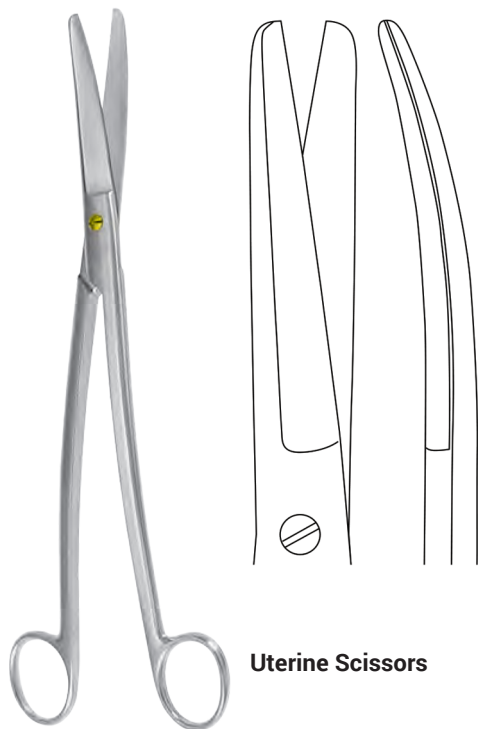

Uterine Scissors

Length 24 cm
Code BB-3990-24



Waldmann

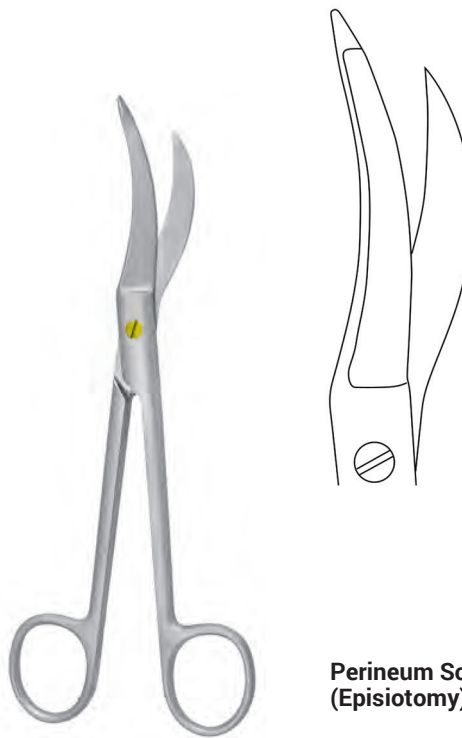

Perineum Scissors (Episiotomy)

Length 18 cm
Code BB-3396-18



Mayo



Surgical Scissors

Length 14 cm
15 cm
17 cm
23 cm
Code BB-3266-14
BB-3266-15
BB-3266-17
BB-3266-23

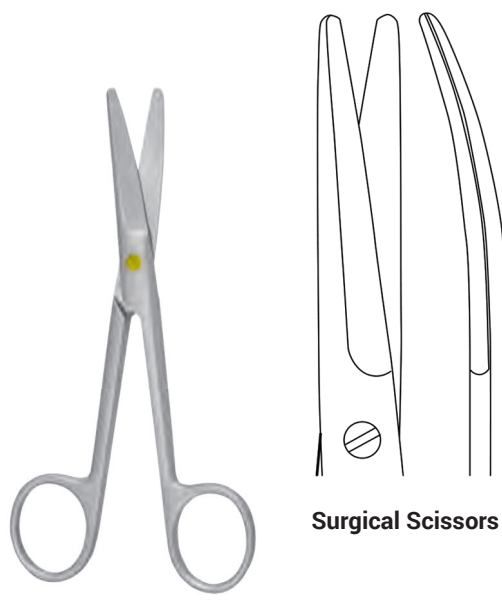

Surgical Scissors

Length 14 cm
15 cm
17 cm
23 cm
Code BB-3269-14
BB-3269-15
BB-3269-17
BB-3269-23





SCISSORS

Mayo-Harrington

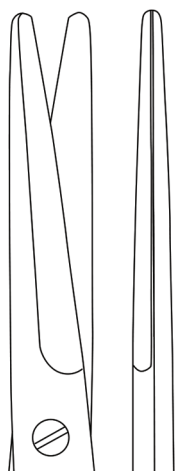

Code
BB-3371-22



Code
BB-3373-22

Surgical Scissors



Surgical Scissors

Length	Code
22 cm	BB-3371-22 - BB-3373-22

Mayo-Stille

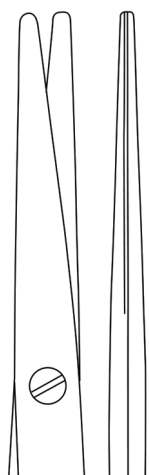

Surgical Scissors



Surgical Scissors

Length	Code
15 cm	BB-3360-15
17 cm	BB-3360-17



Length	Code
15 cm	BB-3361-15
17 cm	BB-3361-17





Metzenbaum

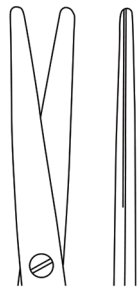

Dissecting Scissors



Length	Code
14 cm	BB-3200-14
18 cm	BB-3200-18
20 cm	BB-3200-20
23 cm	BB-3200-23
25 cm	BB-3200-25
30 cm	BB-3200-30

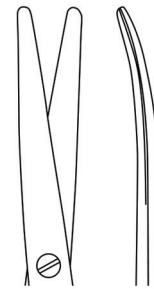

Dissecting Scissors



Length	Code
14 cm	BB-3201-14
18 cm	BB-3201-18
20 cm	BB-3201-20
23 cm	BB-3201-23
25 cm	BB-3201-25
30 cm	BB-3201-30

Metzenbaum-Fino

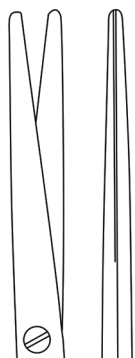

Dissecting Scissors



Length	Code
12 cm	BB-3197-12
14 cm	BB-3197-14
18 cm	BB-3197-18
20 cm	BB-3197-20
23 cm	BB-3197-23



Dissecting Scissors



Length	Code
12 cm	BB-3198-12
14 cm	BB-3198-14
18 cm	BB-3198-18
20 cm	BB-3198-20
23 cm	BB-3198-23

SCISSORS

Metzenbaum-Baby

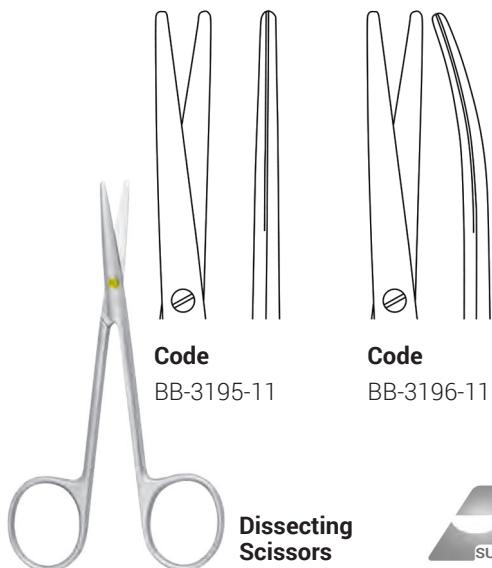

Code
BB-3195-11

Code
BB-3196-11

Dissecting Scissors



Length **Code**
11 cm BB-3195-11 - BB-3196-11

Lexer

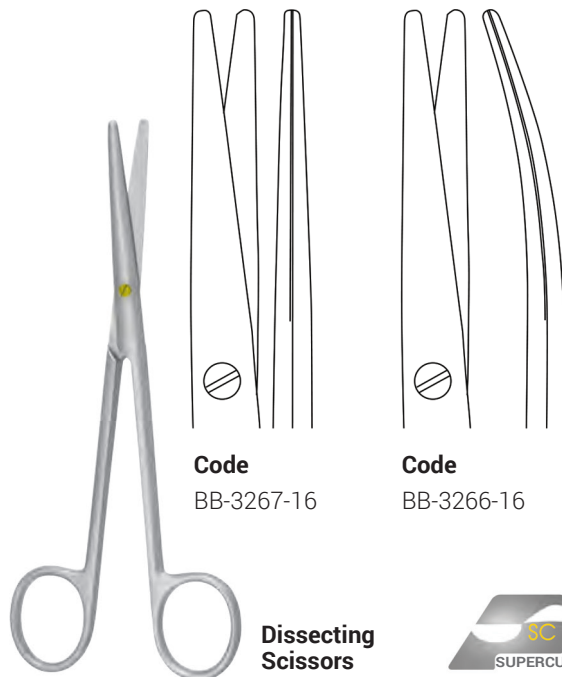

Code
BB-3267-16

Code
BB-3266-16

Dissecting Scissors



Length **Code**
16 cm BB-3267-16 - BB-3266-16

Kilner (Ragnell)

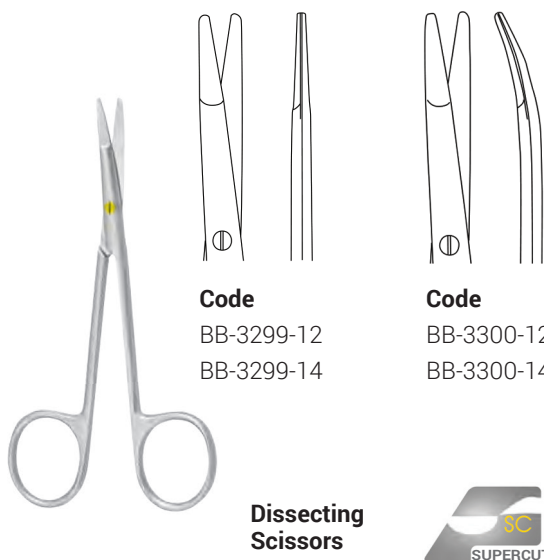

Code
BB-3299-12
BB-3299-14

Code
BB-3300-12
BB-3300-14

Dissecting Scissors



Length **Code**
12 cm BB-3299-12 - BB-3300-12
14 cm BB-3299-14 - BB-3300-14

Jameson

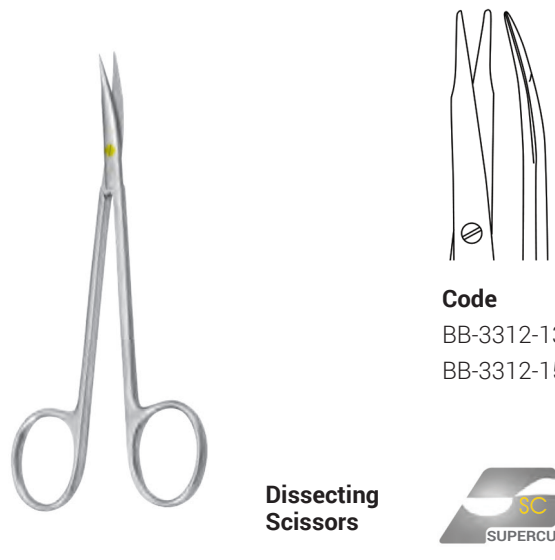

Code
BB-3312-13
BB-3312-15

Dissecting Scissors



Length **Code**
13 cm BB-3312-13 - BB-3312-15

Supercut Scissors 

SCISSORS

Reynolds

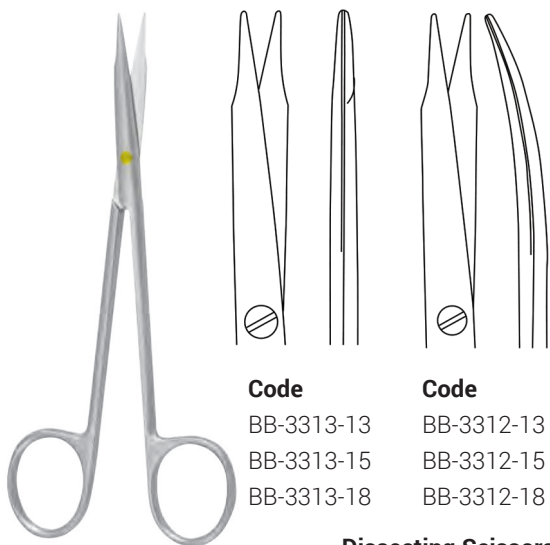

Code	Code
BB-3313-13	BB-3312-13
BB-3313-15	BB-3312-15
BB-3313-18	BB-3312-18

Dissecting Scissors

Length	Code
13 cm	BB-3313-13 - BB-3312-13
15 cm	BB-3313-15 - BB-3312-15
18 cm	BB-3313-18 - BB-3312-18



Heymann

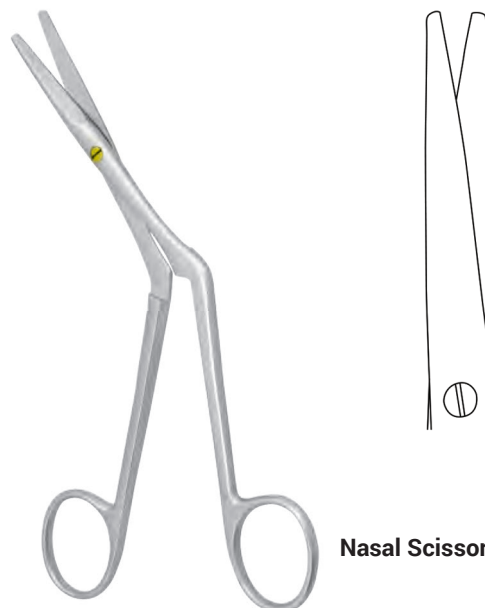

Nasal Scissors

Length	Code
18 cm	BB-3320-18



Kelly

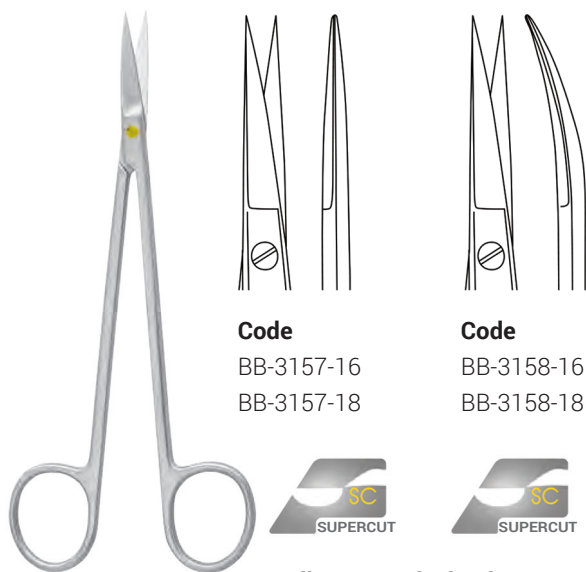

Code	Code
BB-3157-16	BB-3158-16
BB-3157-18	BB-3158-18

Delicate Surgical Scissors

Length	Code
16 cm	BB-3157-16 - BB-3158-16
18 cm	BB-3157-18 - BB-3158-18



Stevens Tenotomy

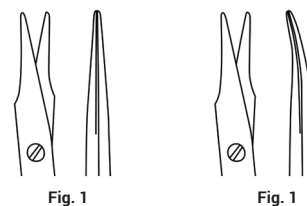

Code	Code
BB-3167-12	BB-3168-12
BB-3167-13	BB-3168-13
BB-3167-18	BB-3168-18

Delicate Surgical Scissors

Length	Code
12 cm	BB-3167-12 - BB-3168-12
13 cm	BB-3167-13 - BB-3168-13
18 cm	BB-3167-18 - BB-3168-18



SCISSORS

Iris

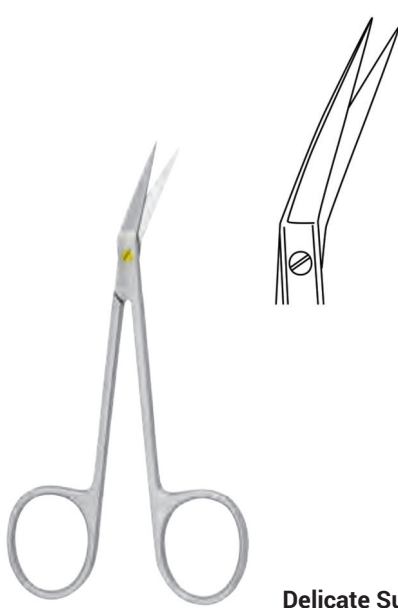

Delicate Surgical Scissors

Length	Code
11 cm	BB-3113-11

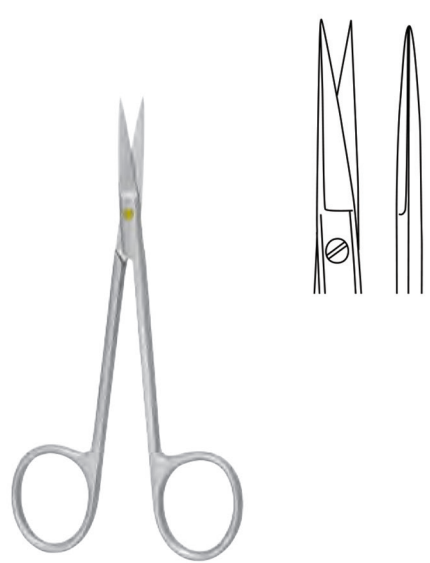

Delicate Surgical Scissors

Length	Code
09 cm	BB-3125-09
11 cm	BB-3125-11



Iris



Delicate Surgical Scissors

Length	Code
09 cm	BB-3126-09
11 cm	BB-3126-11



Jabaley

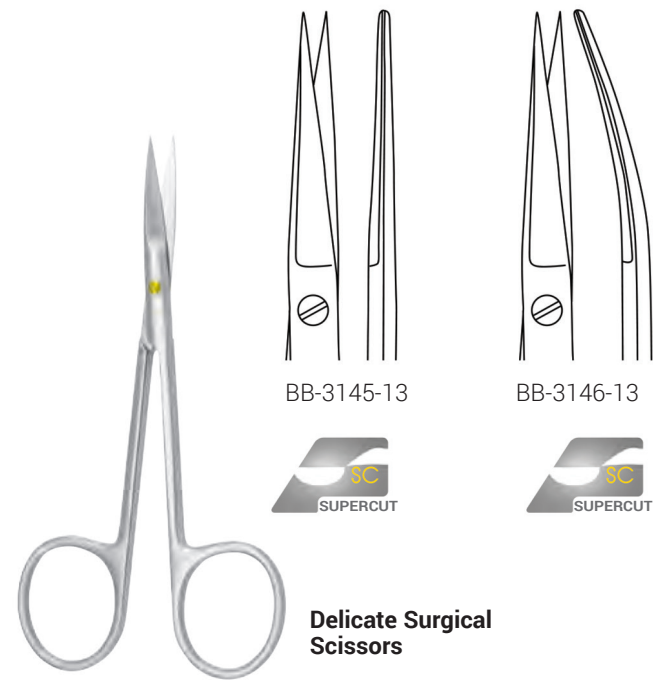

Delicate Surgical Scissors

Length	Code
13 cm	BB-3145-13 - BB-3146-13



Potts-Smith

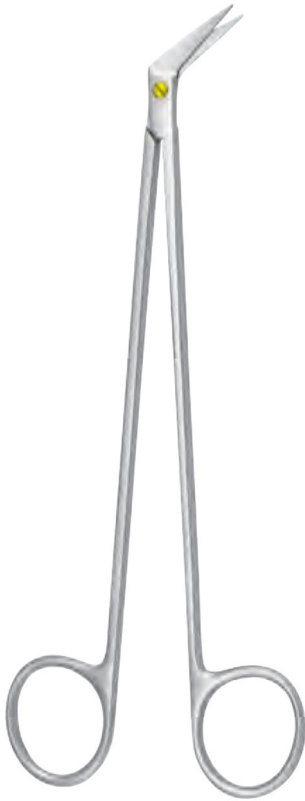

25°

Code

BB-0154-19

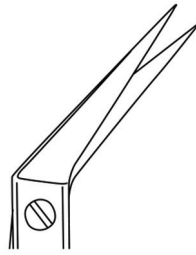

45°

Code

BB-0155-19

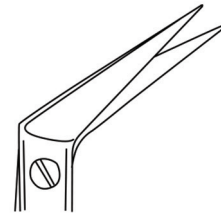

60°

Code

BB-0156-19



Vascular Scissors

Length

19 cm

Code

BB-0154-19 - BB-0155-19 - BB-0156-19

Dietrich-Hegemann

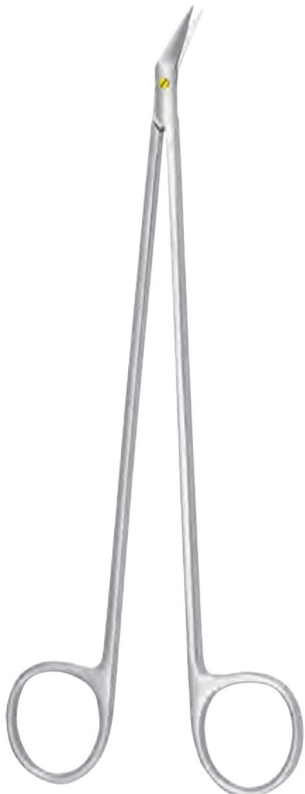

25°

Code

BB-3400-19

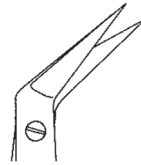

45°

Code

BB-3401-19

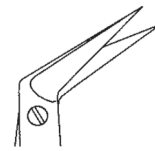

60°

Code

BB-3402-19

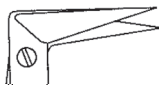

90°

Code

BB-3403-19

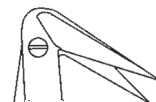

125°

Code

BB-3404-19



Dietrich-Hegemann available in petite point paediatric blades

Vascular Scissors

Length

19 cm

Code

BB-3400-19 - BB-3401-19 - BB-3402-19 - BB-3403-19 - BB-3404-19

Scissors with Tungsten Carbide Edges

- Welded Tungsten Carbide Cutting Edges, therefore no seam tending to corrosion.
- Durable sharp cutting edge.
- Regular and smooth function.

Cutting Geometry

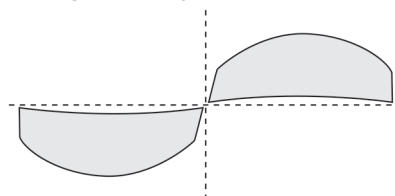

Characteristic: Golden Rings



1 Serrated Blade

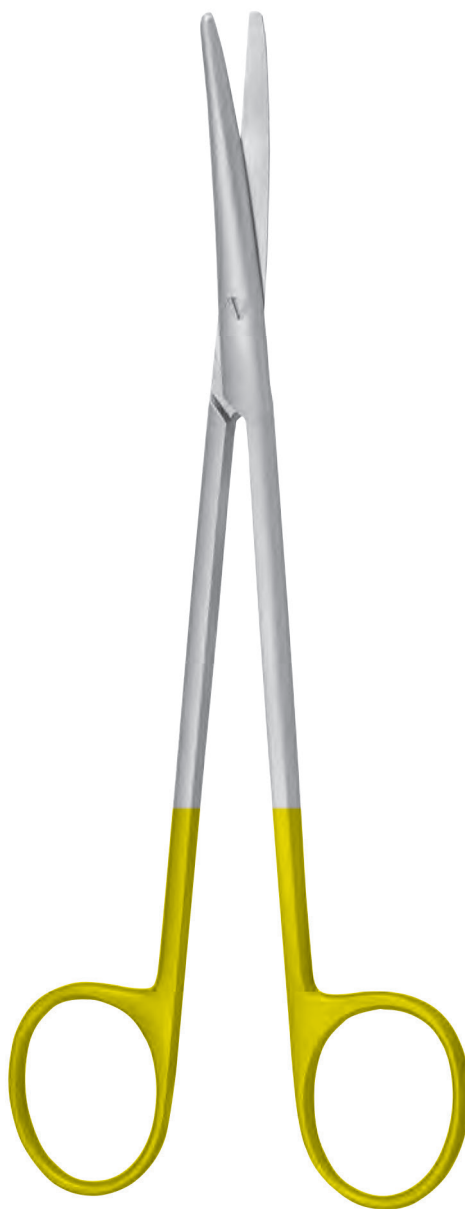



Standard

Fig. 1

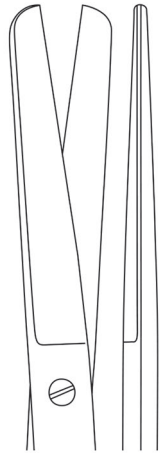

Length	Code
14 cm	BB-2606-14
16 cm	BB-2606-16
18 cm	BB-2606-18

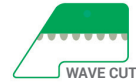

Length	Code
14 cm	BB-2607-14
16 cm	BB-2607-16
18 cm	BB-2607-18

Standard

Fig. 2

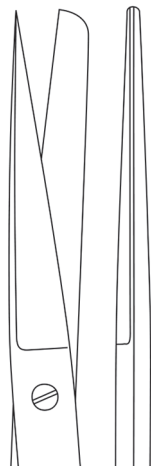

Length	Code
11 cm	BB-2608-11
14 cm	BB-2608-14
16 cm	BB-2608-16
18 cm	BB-2608-18

Fig. 2



Length	Code
14 cm	BB-2609-14
16 cm	BB-2609-16
18 cm	BB-2609-18



SCISSORS

Standard



Fig. 3

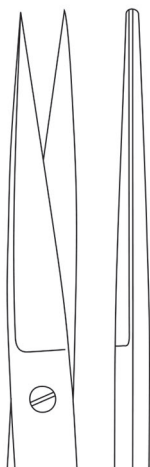

Length	Code
14 cm	BB-2610-14
16 cm	BB-2610-16
18 cm	BB-2610-18



Length	Code
14 cm	BB-2611-14
16 cm	BB-2611-16
18 cm	BB-2611-18

Mixer

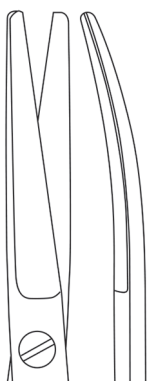

Length	Code
15 cm	BB-2444-15

Waldmann

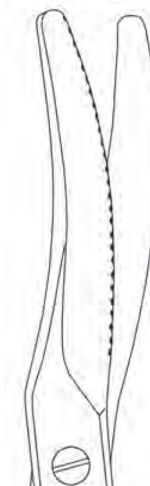

Length	Code
20 cm	BB-2396-20

Perineum Scissors (Episiotomy)

Sims

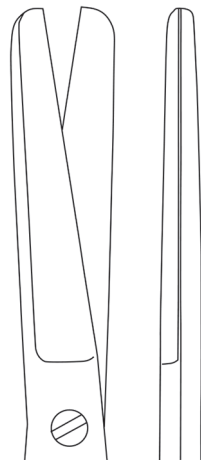

Code
BB-2500-20
BB-2500-23



Code
BB-2509-20
BB-2509-23



Length	Code
20 cm	BB-2500-20 - BB-2509-20
23 cm	BB-2500-23 - BB-2509-23

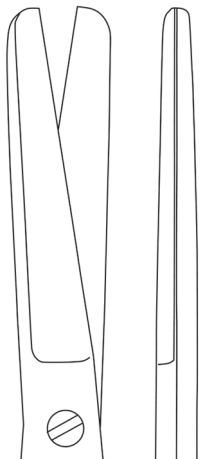

Code
BB-2500-20W
BB-2500-23W



Code
BB-2509-20W
BB-2509-23W



Length	Code
20 cm	BB-2500-20W - BB-2509-20W
23 cm	BB-2500-23W - BB-2509-23W

SCISSORS

Sims

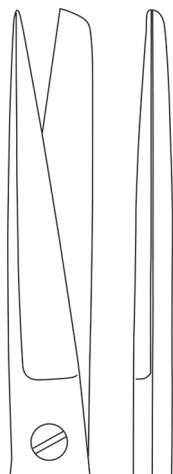

Code
BB-2501-20
BB-2501-23



Code
BB-2502-20
BB-2502-23



Length	Code
20 cm	BB-2501-20 - BB-2502-20
23 cm	BB-2501-23 - BB-2502-23

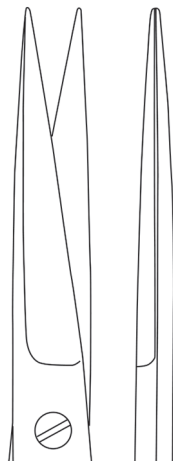

Code
BB-2503-20
BB-2503-23



Code
BB-2504-20
BB-2504-23



Length	Code
20 cm	BB-2503-20 - BB-2504-20
23 cm	BB-2503-23 - BB-2504-23



Mayo

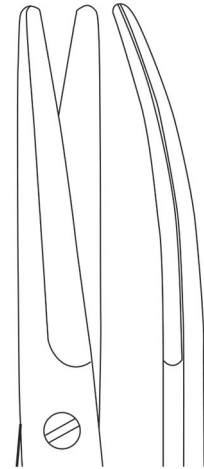
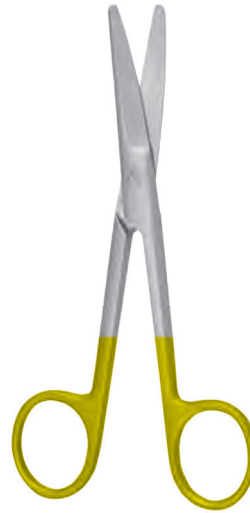
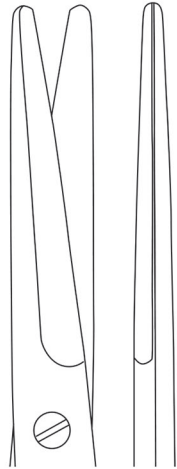

Length	Code
14 cm	BB-2366-14
17 cm	BB-2366-17
23 cm	BB-2366-23
25 cm	BB-2366-25



Length	Code
14 cm	BB-2369-14
17 cm	BB-2369-17
23 cm	BB-2369-23
36 cm	BB-2369-36
40 cm	BB-2369-40



Mayo

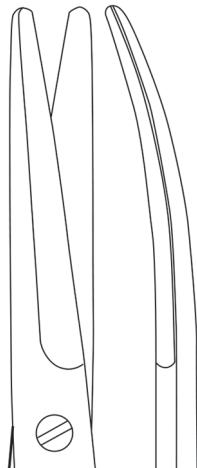

Length	Code
17 cm	BB-2369-17W



Mayo-Harrington

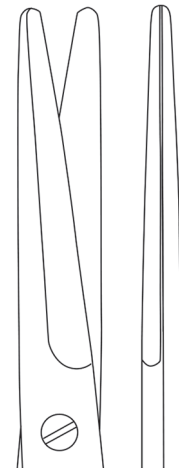

Length	Code
22 cm	BB-2366-22W





Mayo-Harrington

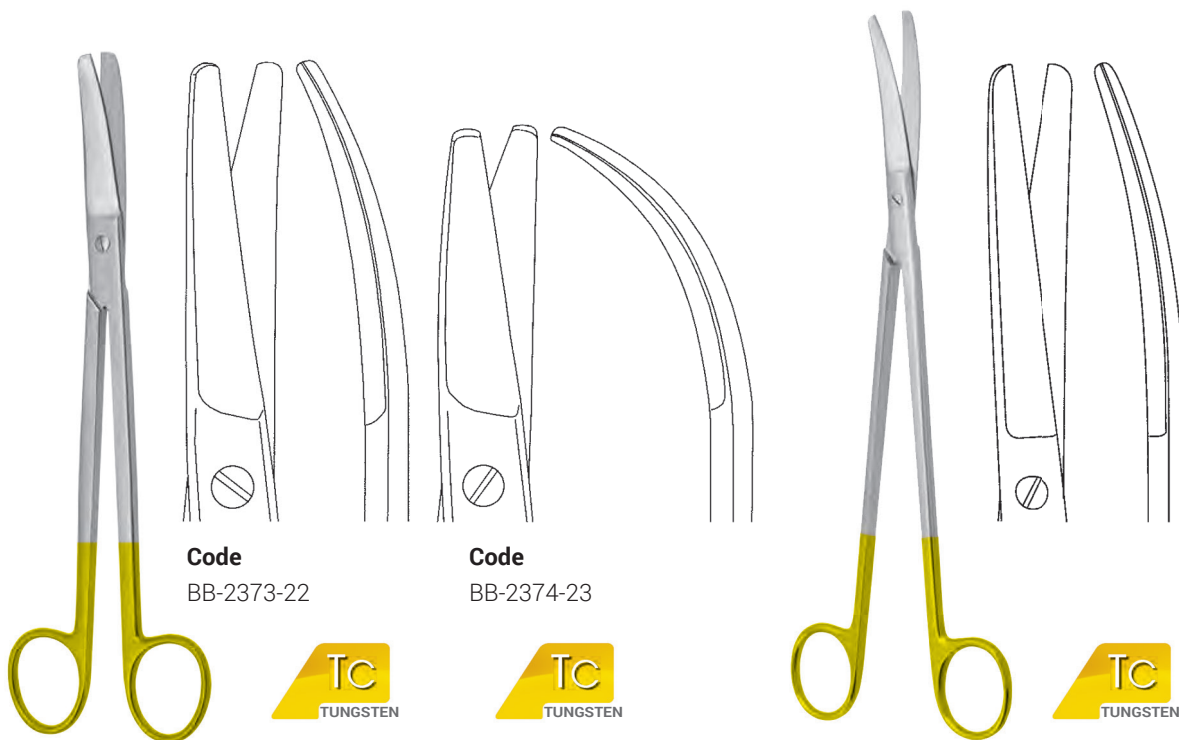

Code
BB-2373-22

Code
BB-2374-23

Length **Code**
23 cm BB-2375-23

Length **Code**
22 cm BB-2373-22
23 cm BB-2374-23

Mayo-Harrington



Length **Code**
25 cm BB-2376-25

Wertheim



Length **Code**
25 cm BB-2378-25



Mayo-Stille

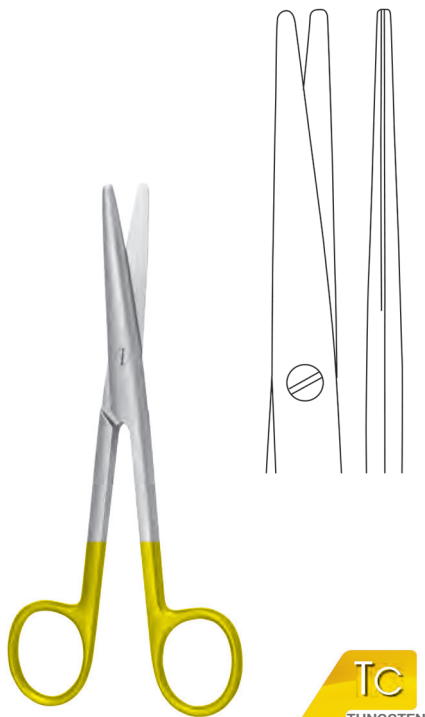

Length	Code
15 cm	BB-2360-15
17 cm	BB-2360-17
21 cm	BB-2360-21

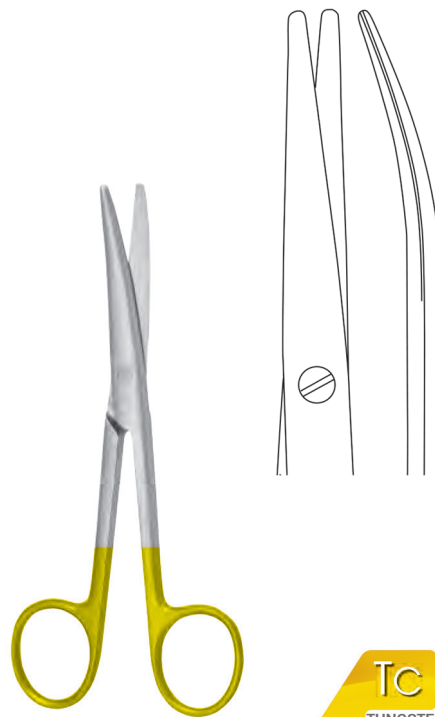

Length	Code
15 cm	BB-2361-15
17 cm	BB-2361-17
21 cm	BB-2361-21

Metzenbaum



Length	Code
11 cm	BB-2200-11
14 cm	BB-2200-14
18 cm	BB-2200-18
20 cm	BB-2200-20
22 cm	BB-2200-22
23 cm	BB-2200-23
25 cm	BB-2200-25
28 cm	BB-2200-28
30 cm	BB-2200-30



Length	Code
11 cm	BB-2201-11
14 cm	BB-2201-14
18 cm	BB-2201-18
20 cm	BB-2201-20
22 cm	BB-2201-22
23 cm	BB-2201-23
25 cm	BB-2201-25
28 cm	BB-2201-28
30 cm	BB-2201-30
36 cm	BB-2201-36
40 cm	BB-2201-40



SCISSORS

Metzenbaum

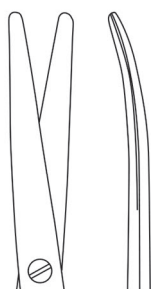
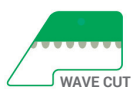
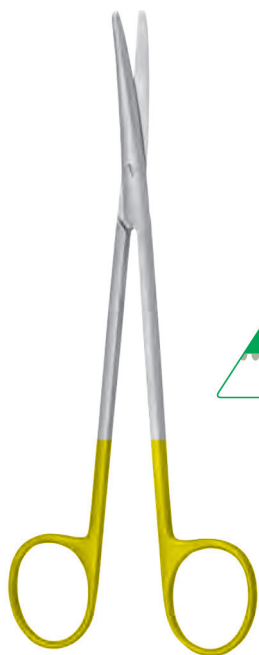

Length	Code
11 cm	BB-2201-11W
14 cm	BB-2201-14W
18 cm	BB-2201-18W
20 cm	BB-2201-20W
23 cm	BB-2201-23W

Metzenbaum-S

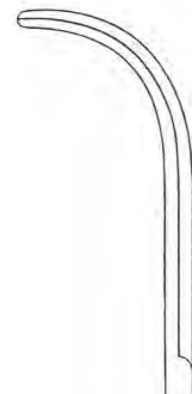

Length	Code
20 cm	BB-2232-20
23 cm	BB-2232-23
25 cm	BB-2232-25
28 cm	BB-2232-28

Metzenbaum

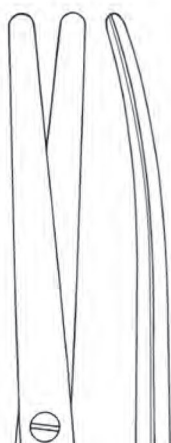

Length	Code
23 cm	BB-2207-23

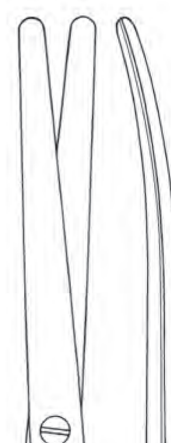
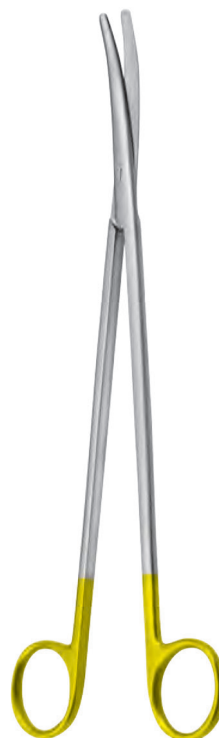

Length	Code
23 cm	BB-2208-23





Metzenbaum-Fino

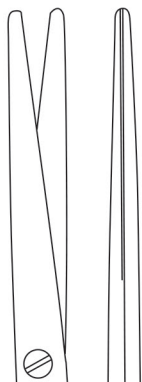
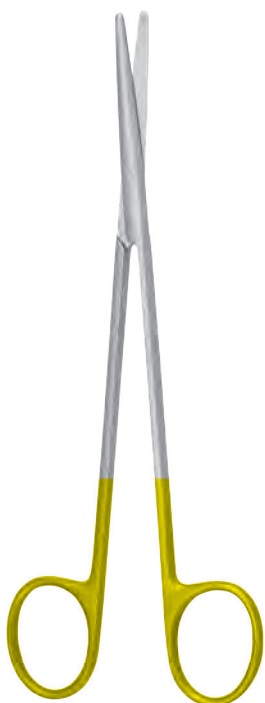

Length	Code
14 cm	BB-2197-14
18 cm	BB-2197-18
20 cm	BB-2197-20
23 cm	BB-2197-23
25 cm	BB-2197-25
28 cm	BB-2197-28

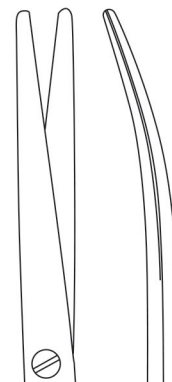

Length	Code
14 cm	BB-2198-14
18 cm	BB-2198-18
20 cm	BB-2198-20
23 cm	BB-2198-23
25 cm	BB-2198-25
28 cm	BB-2198-28

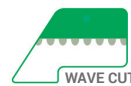

Length	Code
14 cm	BB-2198-14W
18 cm	BB-2198-18W
20 cm	BB-2198-20W
23 cm	BB-2198-23W
25 cm	BB-2198-25W
28 cm	BB-2198-28W



SCISSORS

Metzenbaum-Fino

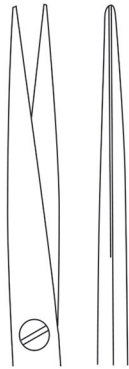

Length	Code
14 cm	BB-2239-14
18 cm	BB-2239-18
20 cm	BB-2239-20
23 cm	BB-2239-23



Length	Code
11 cm	BB-2240-11
14 cm	BB-2240-14
18 cm	BB-2240-18
20 cm	BB-2240-20
23 cm	BB-2240-23

Metzenbaum-Fino-S

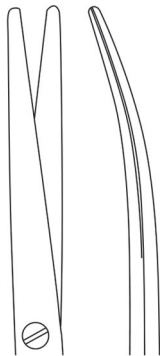
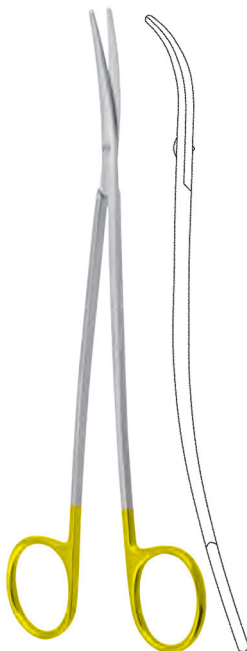

Length	Code
18 cm	BB-2172-18
20 cm	BB-2172-20
23 cm	BB-2172-23

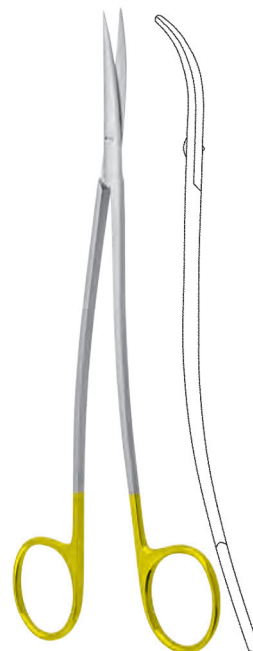

Length	Code
18 cm	BB-2173-18
20 cm	BB-2173-20
23 cm	BB-2173-23

Dissecting Scissors



SCISSORS

Mayo-Lexer

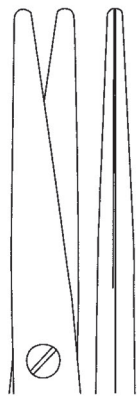

Code
BB-2370-16
BB-2370-21



Code
BB-2371-16
BB-2371-21



Length	Code
16 cm	BB-2370-16 - BB-2371-16
21 cm	BB-2370-21 - BB-2371-21

Lexer

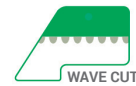
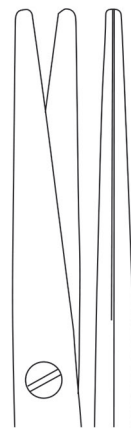
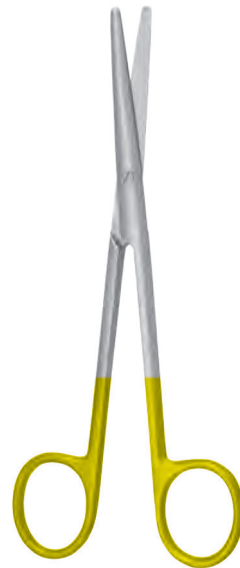

Length	Code
16 cm	BB-2267-16W

Lexer

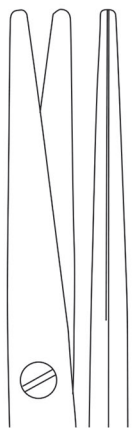
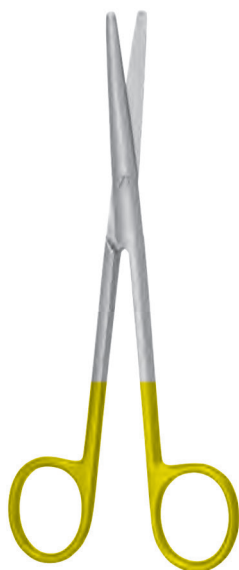

Code
BB-2267-16

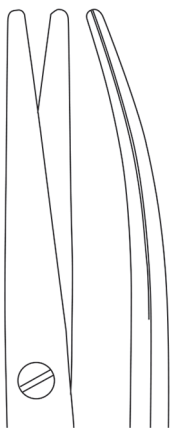

Code
BB-2266-16



Length	Code
16 cm	BB-2267-16 - BB-2266-16

Thorek

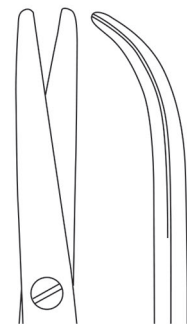

Length	Code
20 cm	BB-2304-20
23 cm	BB-2304-23
28 cm	BB-2304-28

SCISSORS

Dissecting Scissors

Joseph



Length	Code
14 cm	BB-2151-14
17 cm	BB-2151-17

Kilner



Length	Code
12 cm	BB-2299-12
14 cm	BB-2299-14

Jameson



Length	Code
13 cm	BB-2312-13
15 cm	BB-0312-15

Reynolds

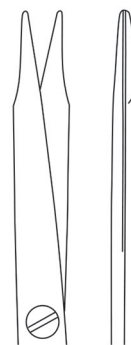

Length	Code
15 cm	BB-2313-15



Reynolds

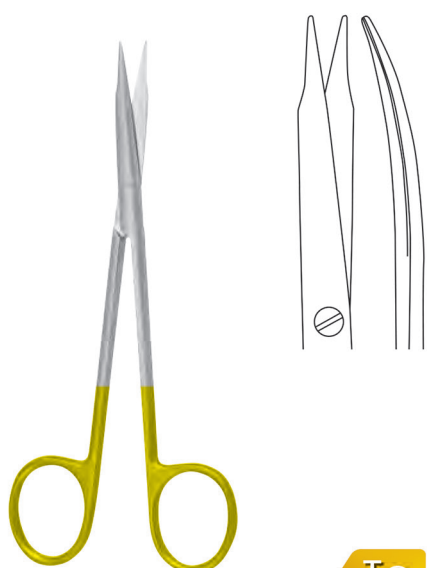

Length	Code
15 cm	BB-2312-15
18 cm	BB-2312-18

Metzenbaum-Lahey

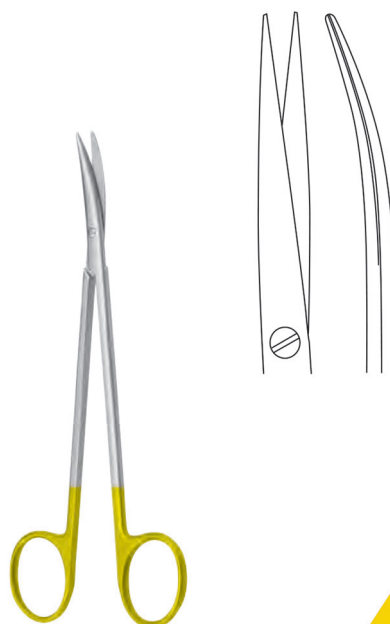

Length	Code
14 cm	BB-2238-14

Metzenbaum-Lahey

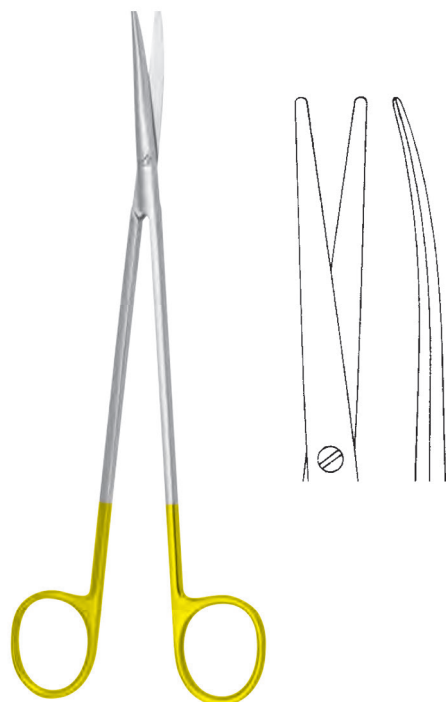

Length	Code
20 cm	BB-2238-20
23 cm	BB-2238-23

Toennis-Adson



Length	Code
17 cm	BB-2295-17

Length	Code
17 cm	BB-2295-17W

SCISSORS

Tonsil Scissors, Nasal Scissors



Dean

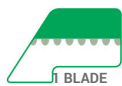
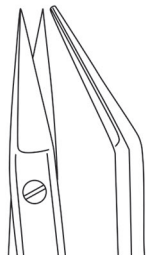
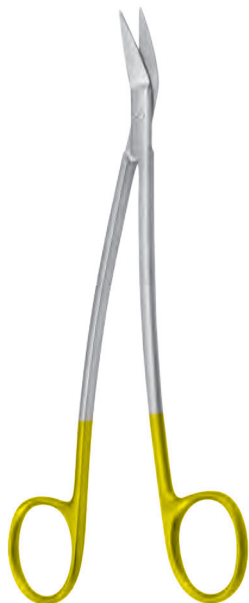

Tonsil Scissors

Length 17 cm
Code BB-2250-17

Fomon



Nasal Scissors

Length 13 cm
Code BB-2046-13

Fomon



Nasal Scissors

Length 13 cm
Code BB-2236-13

Cottle



Nasal Scissors

Length 16 cm
Code BB-2328-16

Face-lift Scissors



SCISSORS

Gorney

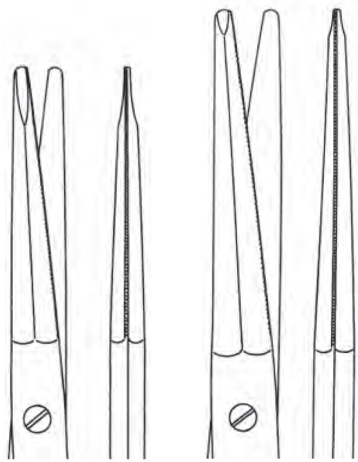

Code
BB-2901-20

Code
BB-2901-23

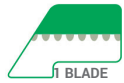
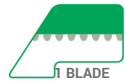

Length	Code
20 cm	BB-2901-20
23 cm	BB-2901-23

Fomon

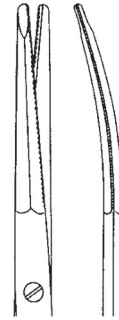

Length	Code
14 cm	BB-2327-14

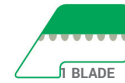

Kaye



Length	Code
15 cm	BB-2866-15
18 cm	BB-2866-18



Stella

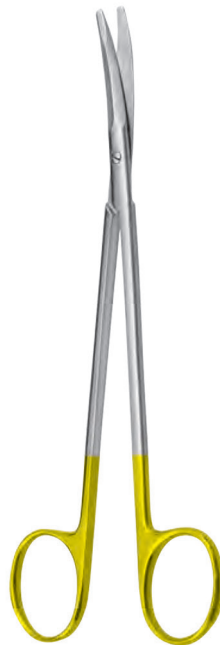

Length	Code
14 cm	BB-2877-14



Gorney-Freeman

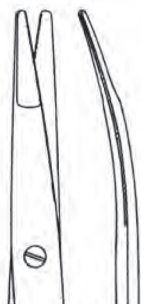
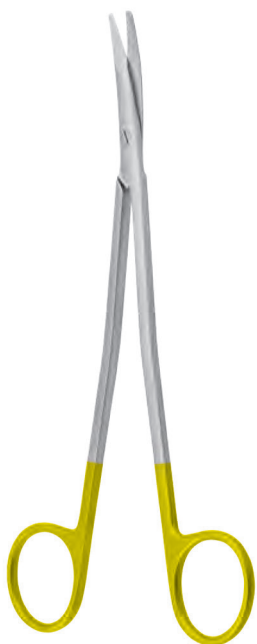

Length **Code**
18 cm BB-2878-18

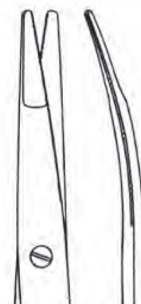
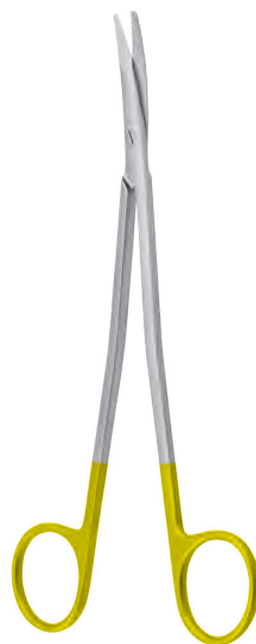

Length **Code**
23 cm BB-2879-23

Freeman-Kaye

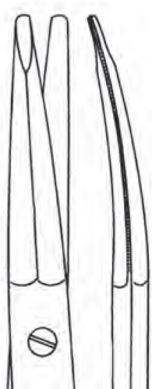

Length **Code**
18 cm BB-2880-18

Freeman-Gorney



Length **Code**
23 cm BB-2881-23

Delicate Surgical Scissors



SCISSORS

Kelly

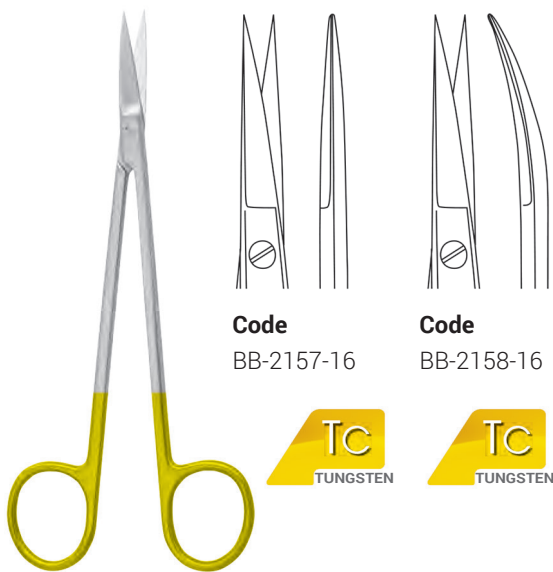

Code
BB-2157-16

Code
BB-2158-16



Length 16 cm
Code BB-2157-16 - BB-2158-16

Joseph

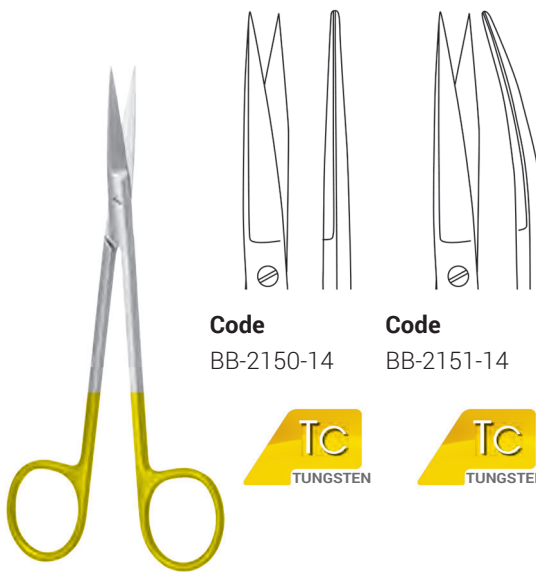

Code
BB-2150-14

Code
BB-2151-14



Length 14 cm
Code BB-2150-14 - BB-2151-14

Goldmann-Fox

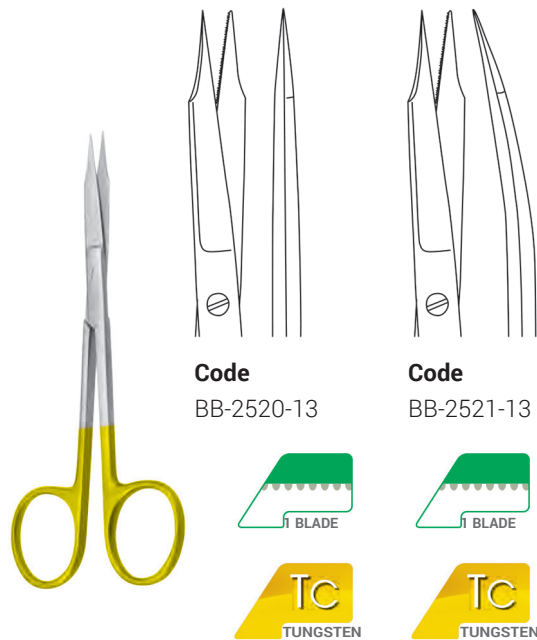

Code
BB-2520-13

Code
BB-2521-13



Gum Scissors

Length 13 cm
Code BB-2520-13 - BB-2521-13

Wagner

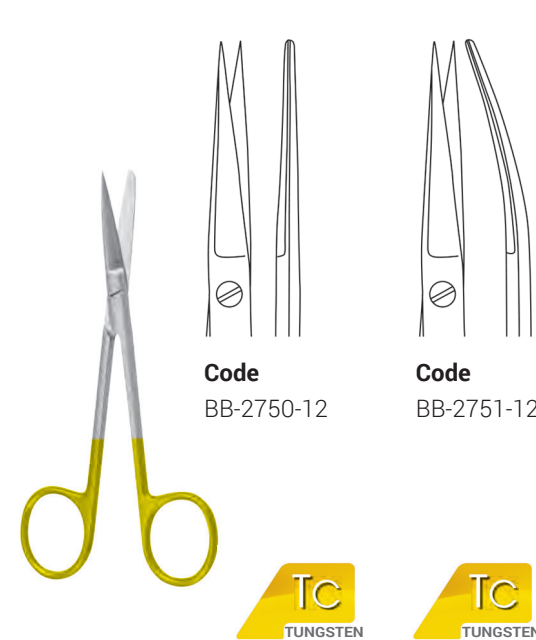

Code
BB-2750-12

Code
BB-2751-12



Length 12 cm
Code BB-2750-12 - BB-2751-12



Iris

Code BB-2110-11	Code BB-2111-11	Code BB-2113-11	Code BB-2111-11W
Length 11 cm	Code BB-2110-11 - BB-2111-11 - BB-2113-11	Length 11 cm	Code BB-2111-11W

Locklin

Length 16 cm	Code BB-2536-16

Gum Scissors

Locklin-S

Length 16 cm	Code BB-2537-16

Gum Scissors



DeBakey

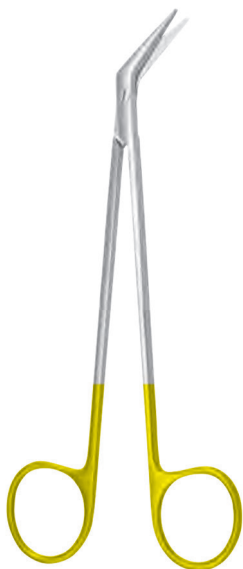

25°

Code

BB-2410-16

BB-2410-23

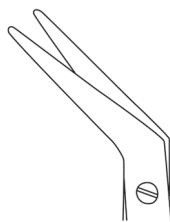

45°

Code

BB-2420-16

BB-2420-23

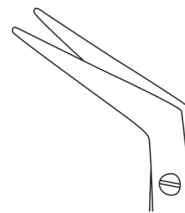

60°

Code

BB-2430-16

BB-2430-23



Length

Code

16 cm BB-2410-16 - BB-2420-16 - BB-2430-16

23 cm BB-2410-23 - BB-2420-23 - BB-2430-23

Potts-Smith

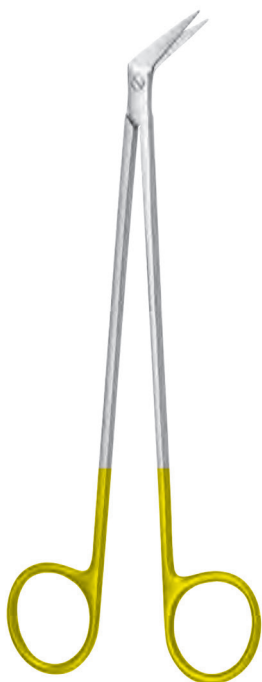

25°

Code

BB-2154-19

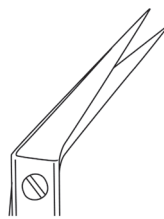

45°

Code

BB-2155-19

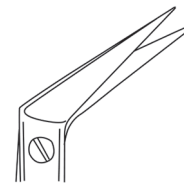

60°

Code

BB-2156-19



Length

Code

19 cm BB-2154-19 - BB-2155-19 - BB-2156-19

Dietrich-Hegemann

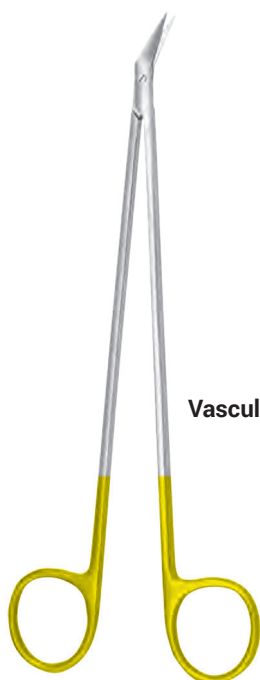

Vascular Scissors



Code
BB-2400-18

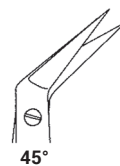

Code
BB-2401-18

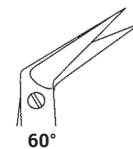

Code
BB-2402-18

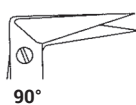

Code
BB-2403-18



Code
BB-2404-18



Dietrich-Hegemann available in petite point paediatric blades

Length	Code
18 cm	BB-2400-18 - BB-2401-18 - BB-2402-18 - BB-2403-18 - BB-2404-18

Universal

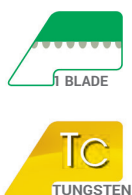
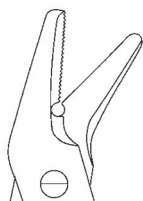

Length	Code
12 cm	BB-2546-12

Smith

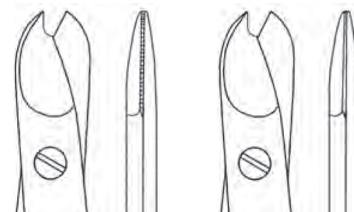
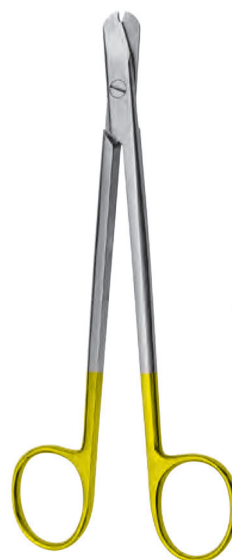

Code
BB-2547-16

Code
BB-2548-16



Length	Code
16 cm	BB-2547-16 - BB2548-16



Mayo

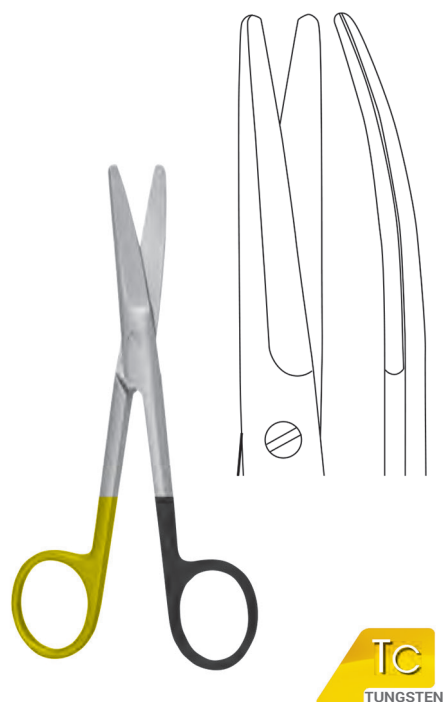

Length	Code
14 cm	BB-5369-14
17 cm	BB-5369-17
23 cm	BB-5369-23

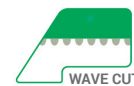
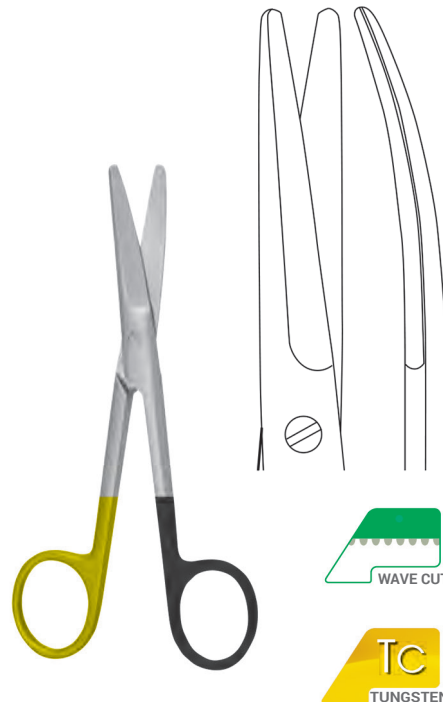

Length	Code
14 cm	BB-5369-14W
17 cm	BB-5369-17W
23 cm	BB-5369-23W

Metzenbaum



Length	Code
14 cm	BB-5201-14W
18 cm	BB-5201-18W
20 cm	BB-5201-20W
23 cm	BB-5201-23W

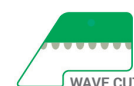

Length	Code
26 cm	BB-5201-26W

Supercut Titanium-Nitrite Scissors

Scissors with **SUPERCUT TITANIUM-NITRITE** have one razor blade which allows an easy and clean cut through tissue. **TITANIUM NITRITE** coatings:

- The glide quality of the instruments is considerably improved by electrophysical smoothing, resulting in less abrasion and reduced wear.
- The exceptional smoothness means that the scissor blades slide easily, even under maximum stress.
- The smooth surface makes the scissors much easier to clean.
- The coating makes the surface three to five times harder. This multiplies the lifetime of the cutting edges and makes the instruments extremely resistant to scratches and impacts.
- The coating is largely inert, which means that the molecular binding is very chemically resistant. This prevents undesirable reactions when the instruments are immersed in solutions or sterilised.
- Even under intensive use of acid or alkaline solutions, the high level of surface smoothness is retained.
- The inert coating is also stable at high temperatures.

Characteristics of TIN - coatings:

- 3-5 Times harder than hardened steel.
- Smooth, impervious, ceramic material structure.
- High-grade surface finish, reduced reflection.
- Anti-corrosive, easy to clean surface.
- Far more resistant to solvents and aggressive fluids than uncoated steel.
- Scratch-resistant.
- Temperature-resistant.
- High level of adherence.
- Low friction.



**Characteristic:
Black Finish,
Golden Screw**

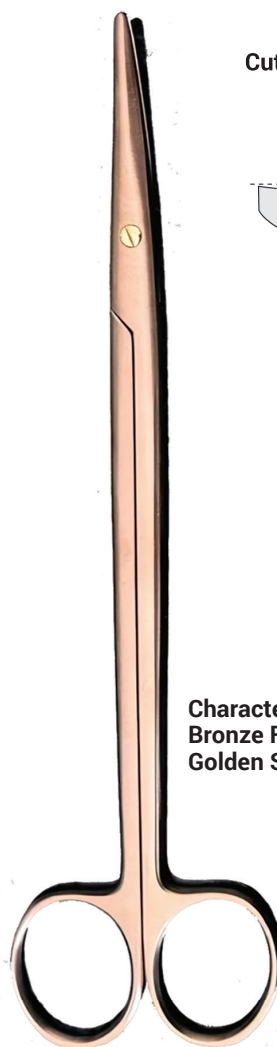

**Characteristic:
Bronze Finish,
Golden Screw**

Cutting Geometry

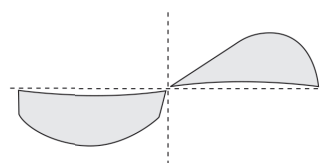

Supercut TITANIUM-NITRIDE Scissors



SCISSORS

Sims

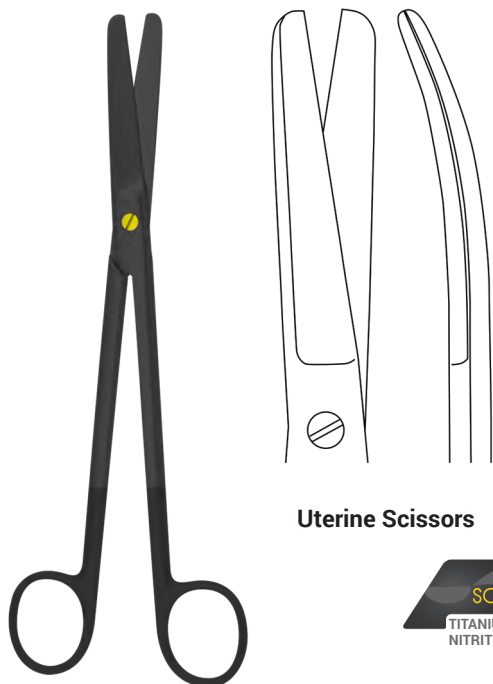

Uterine Scissors



Length	Code
20 cm	BB-5509-20
23 cm	BB-5509-23

Mayo-Harrington

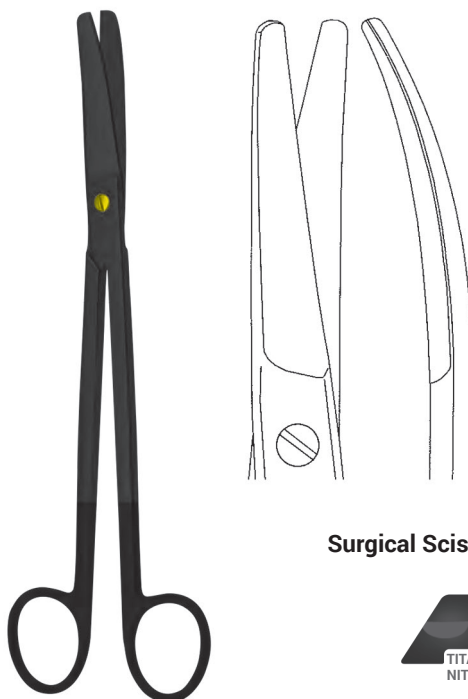

Surgical Scissors



Length	Code
22 cm	BB-5373-22

Mayo

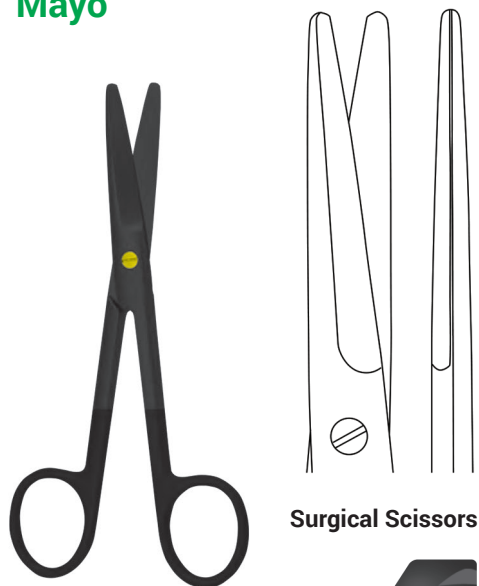

Surgical Scissors



Length	Code
14 cm	BB-5366-14
17 cm	BB-5366-17
23 cm	BB-5366-23

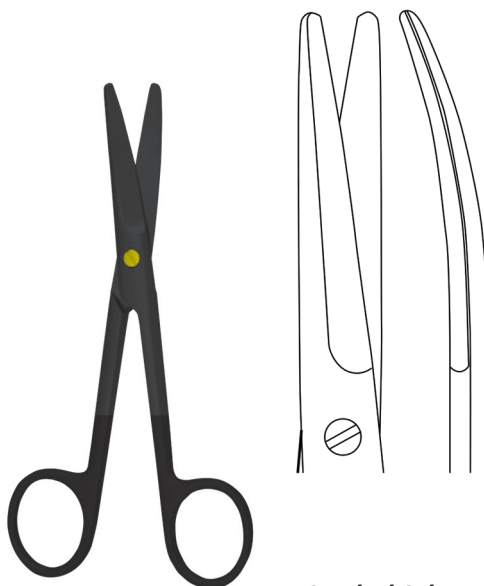

Surgical Scissors



Length	Code
14 cm	BB-5369-14
17 cm	BB-5369-17
23 cm	BB-5369-23



Mayo-Stille

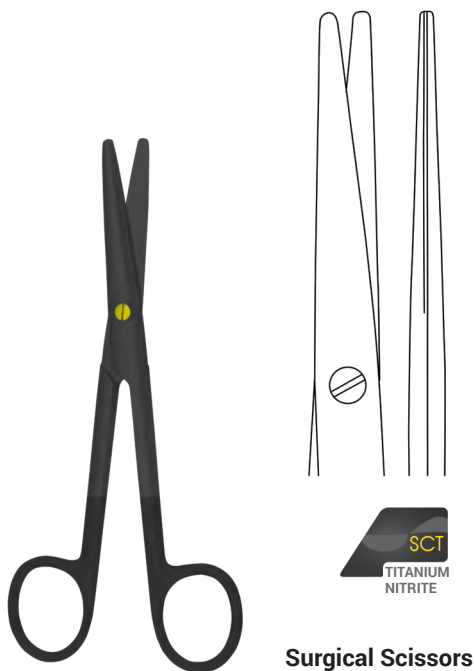

Surgical Scissors

Length	Code
15 cm	BB-5360-15
17 cm	BB-5360-17
21 cm	BB-5360-21

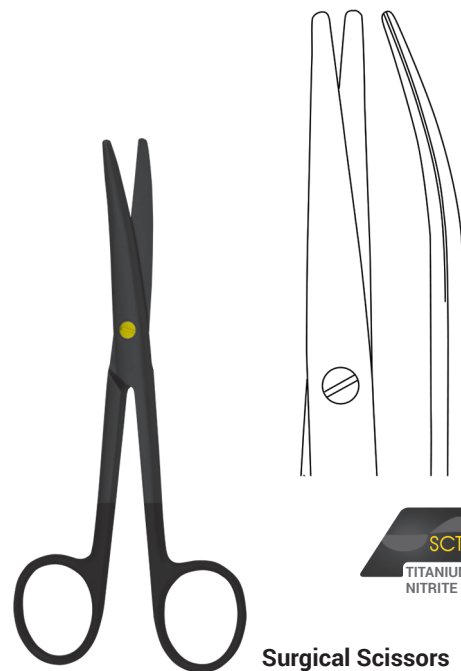

Surgical Scissors

Length	Code
15 cm	BB-5361-15
17 cm	BB-5361-17
21 cm	BB-5361-21

Metzenbaum



Dissecting Scissors

Length	Code
11 cm	BB-5200-11
14 cm	BB-5200-14
18 cm	BB-5200-18
20 cm	BB-5200-20
23 cm	BB-5200-23
25 cm	BB-5200-25
28 cm	BB-5200-28
30 cm	BB-5200-30



Dissecting Scissors

Length	Code
11 cm	BB-5201-11
14 cm	BB-5201-14
18 cm	BB-5201-18
20 cm	BB-5201-20
23 cm	BB-5201-23
25 cm	BB-5201-25
28 cm	BB-5201-28
30 cm	BB-5201-30

Supercut TITANIUM-NITRITE Scissors



SCISSORS

Metzenbaum-Fino



Dissecting Scissors



Length	Code
11 cm	BB-5198-11
14 cm	BB-5198-14
18 cm	BB-5198-18
20 cm	BB-5198-20
23 cm	BB-5198-23
25 cm	BB-5198-25
28 cm	BB-5198-28

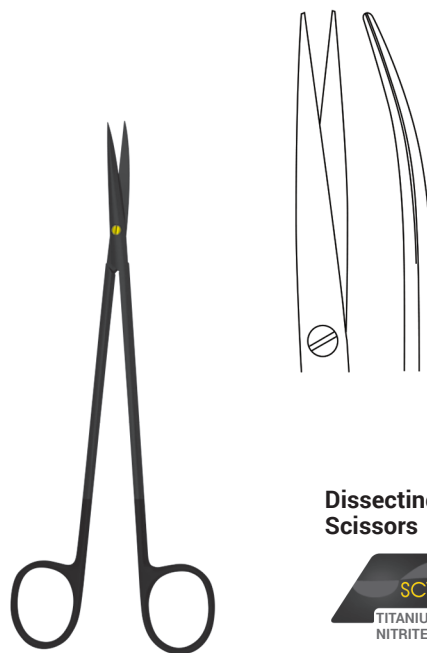

Dissecting Scissors



Length	Code
14 cm	BB-5240-14

Metzenbaum-Fino



Dissecting Scissors



Length	Code
14 cm	BB-5172-14

Lexer

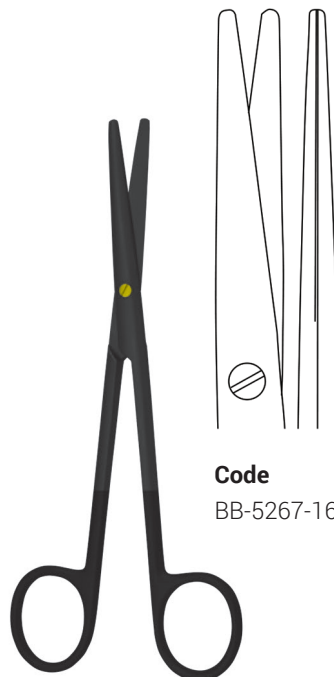

Code
BB-5267-16



Code
BB-5266-16

Dissecting Scissors



Length	Code
16 cm	BB-5267-16 - BB-5266-16

SCISSORS

Supercut TITANIUM-NITRITE Scissors



Jameson

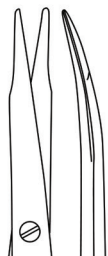

Dissecting Scissors



Length 15 cm
Code BB-5312-15

Reynolds



Dissecting Scissors



Length 15 cm
Code BB-5314-15

Toennis-Adson



Dissecting Scissors



Length 17 cm
Code BB-5297-17

Fomon



Nasal Scissors



Length 13 cm
Code BB-5236-13

Supercut TITANIUM-NITRITE Scissors



SCISSORS

Heymann



Nasal Scissors



Length 18 cm
Code BB-5320-18

Gregory



Code
BB-BB-5321-18



Code
BB-BB-5322-18

Face-lift Scissors



Length 18 cm
23 cm
Code BB-5321-18 - BB-5322-18
BB-5321-23 - BB-5322-23

Kelly

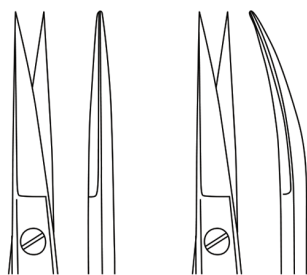

Code BB-5157-16
Code BB-5158-16

Delicate Surgical Scissors



Length 16 cm
Code BB-5157-16 - BB-5158-16

Joseph

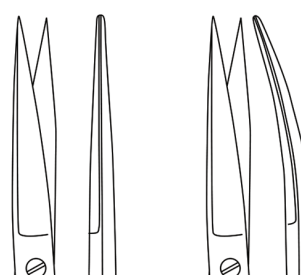

Code BB-5150-14
Code BB-5151-14

Delicate Surgical Scissors



Length 14 cm
Code BB-5150-14 - BB-5151-14

Supercut TITANIUM-NITRITE Scissors



Stevens Tenotomy

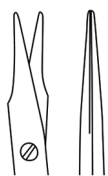
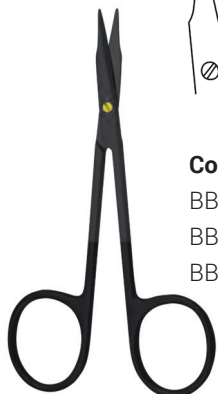

Fig. 1



Fig. 1

Code
BB-5167-12
BB-5167-13
BB-5167-18

Code
BB-5168-12
BB-5168-13
BB-5168-18



Delicate Surgical Scissors

Length	Code
12 cm	BB-5167-12 - BB-5168-12
13 cm	BB-5167-13 - BB-5168-13
18 cm	BB-5167-18 - BB-5168-18

Iris



Code
BB-5110-11



Code
BB-5111-11



Delicate Surgical Scissors

Length	Code
11 cm	BB-5110-11 - BB-5111-11

Dietrich-Hegemann

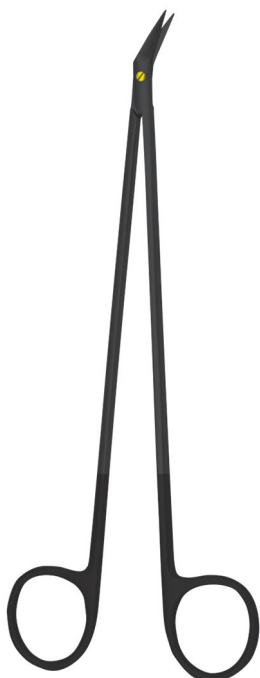

25°

Code
BB-5400-19

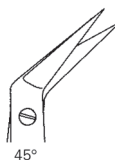

45°

Code
BB-5401-19

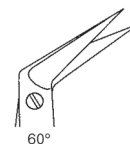

60°

Code
BB-5402-19

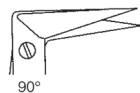

90°

Code
BB-5403-19

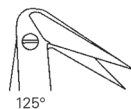

125°

Code
BB-5404-19



Dietrich-Hegemann available in petite point paediatric blades

Vascular Scissors

Length	Code
19 cm	BB-5400-19 - BB-5401-19 - BB-5402-19 - BB-5403-19 - BB-5404-19

Supercut TITANIUM-NITRIDE Scissors



SCISSORS

Potts-de Martel

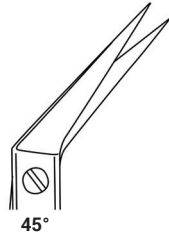

45°

Length
21 cm

Code
BB-5159-21

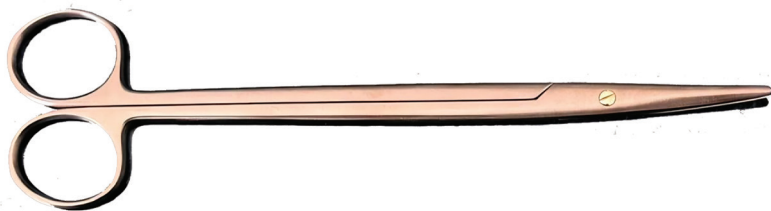
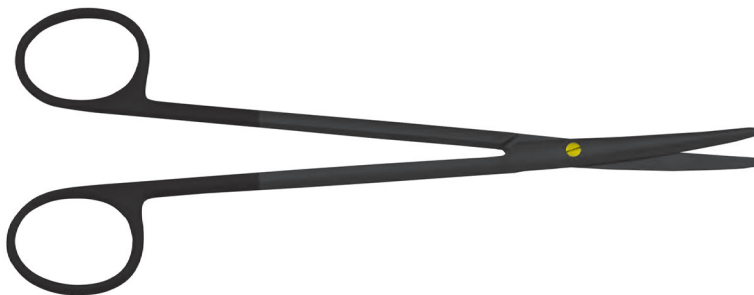
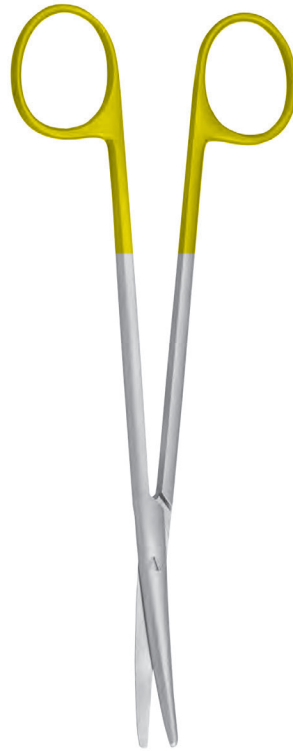

SCISSORS

Micro Scissors Round Handle 18 cm

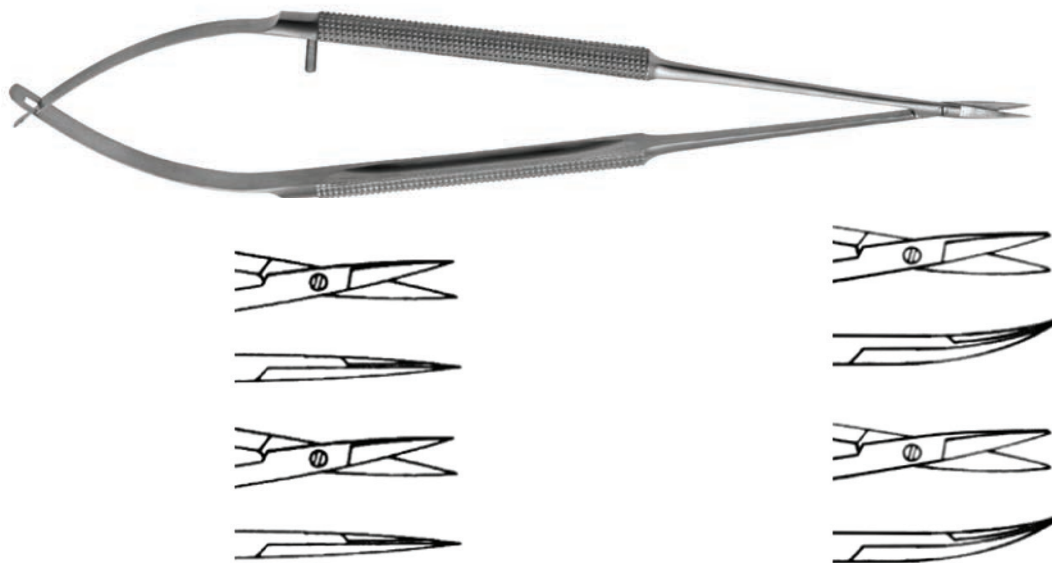

Description

- Micro Scissors Round Handle Straight 9 mm Blades
- Micro Scissors Round Handle Curved 9 mm Blades
- Micro Scissors Round Handle Straight 10 mm Blades
- Micro Scissors Round Handle Curved 10 mm Blades

Code

- BB-2203-01
- BB-2203-02
- BB-2203-03
- BB-2203-04

Titanium Micro Scissors Round Handle 18 cm



Description

- Titanium Micro Scissors
Round Handle Straight 9 mm Blades
- Titanium Micro Scissors
Round Handle Curved 9 mm Blades

Code

- BB-2205-18T
- BB-2206-18T

Micro Scissors Flat Handle 18 cm

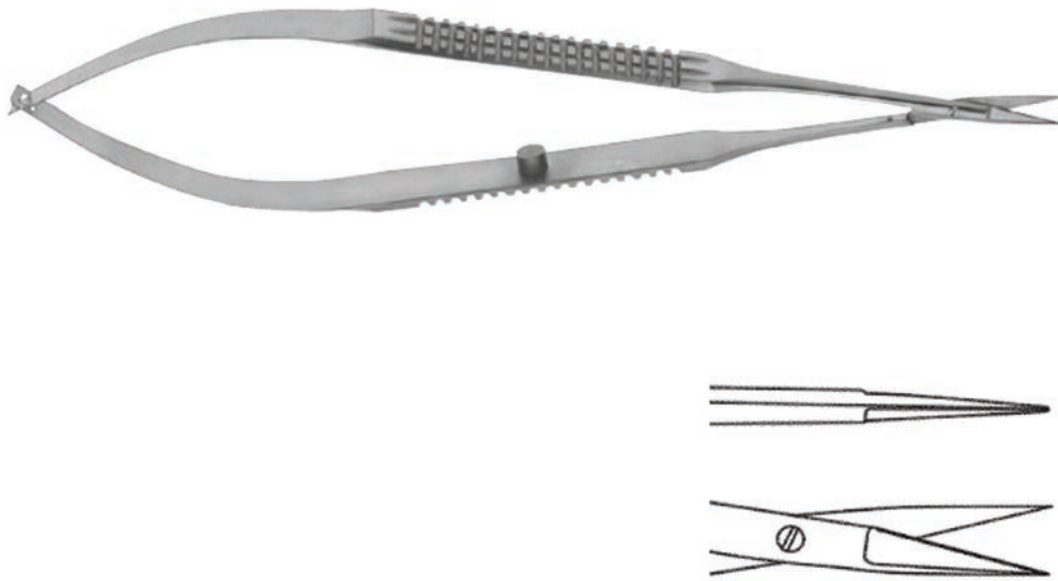

Description

Micro Scissors Flat Handle Straight 9 mm Blades

Code

BB-2207-18

Titanium Micro Scissors Flat Handle 18 cm

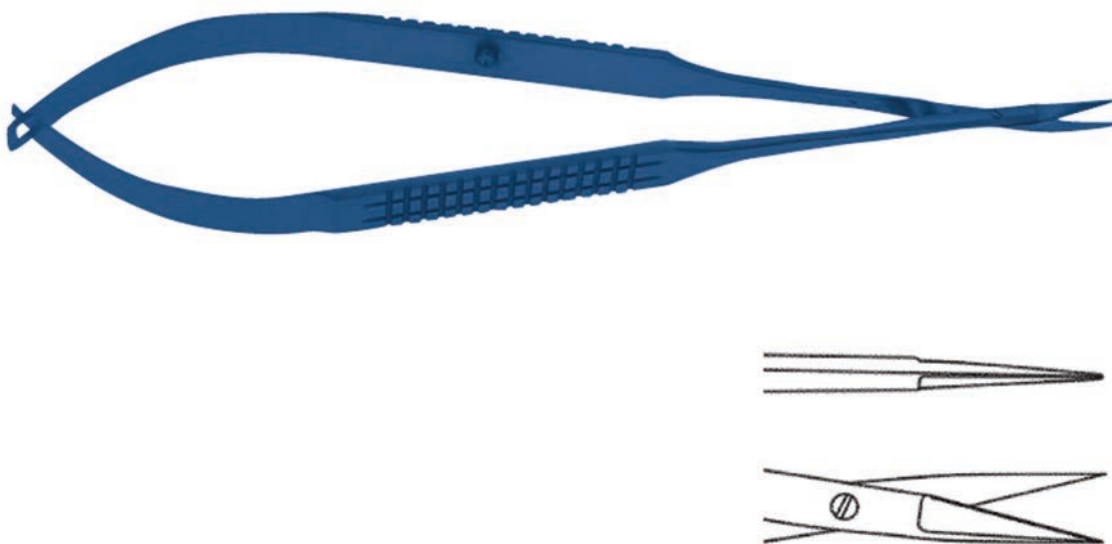

Description

Titanium Micro Scissors Flat Handle Straight 9 mm Blades

Code

BB-2208-18T

SCISSORS

Micro Scissors Flat Handle 18 cm

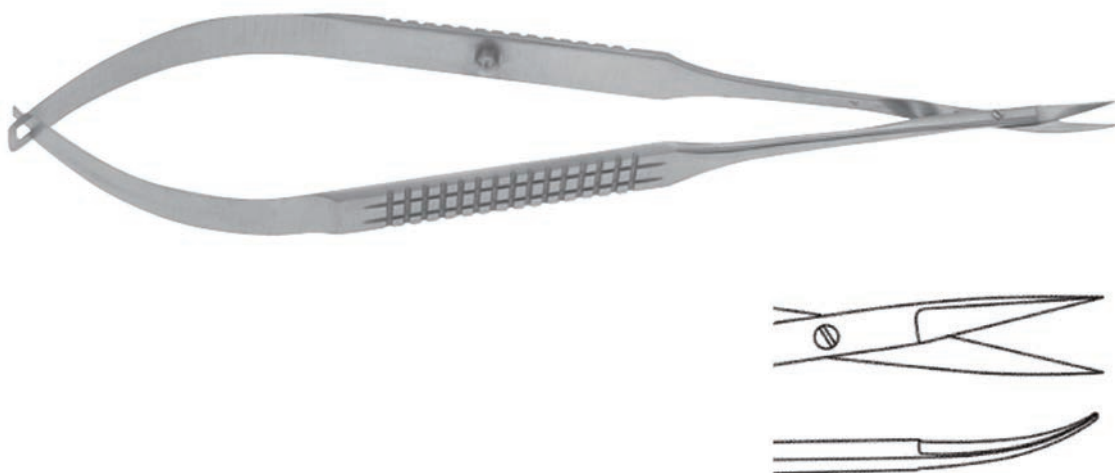

Description

Micro Scissors Flat Handle Curved 9 mm Blades

Code

BB-2208-18

Titanium Micro Scissors Flat Handle 18 cm

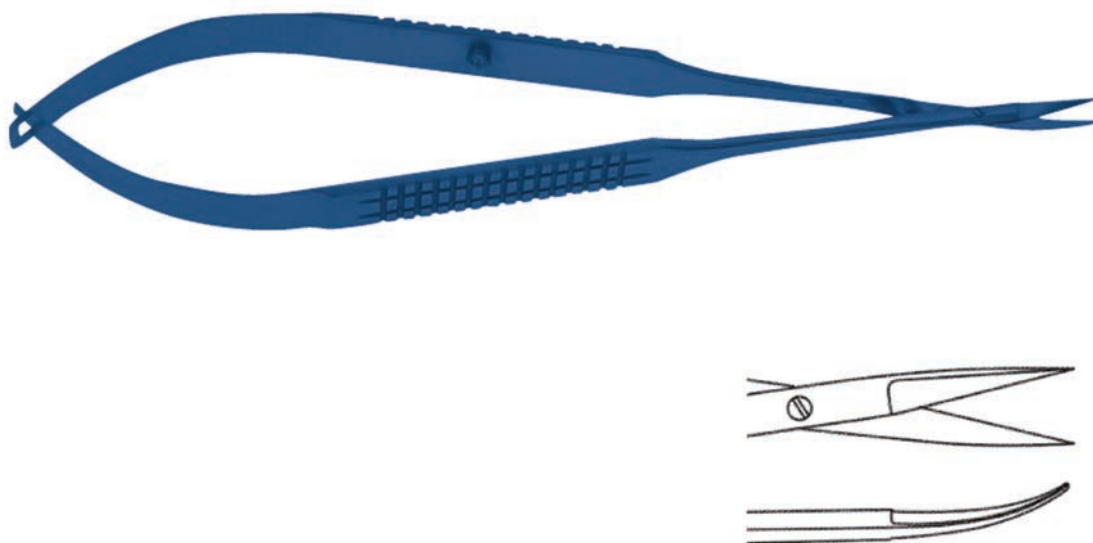

Description

Titanium Micro Scissors Flat Handle Curved 9 mm Blades

Code

BB-2209-18T

Micro Scissors Flat Handle

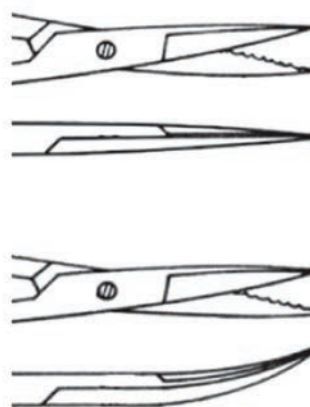

Description

Length

Code

Micro Scissors Flat Handle Straight 9 mm Blades	15 cm	BB-2209-15
Micro Scissors Flat Handle Curved 9 mm Blades	15 cm	BB-2210-15
Micro Scissors Flat Handle Straight 9 mm Blades	18 cm	BB-2209-18
Micro Scissors Flat Handle Curved 9 mm Blades	18 cm	BB-2210-18
Micro Scissors Flat Handle Straight 9 mm Blades	21 cm	BB-2209-21
Micro Scissors Flat Handle Curved 9 mm Blades	21 cm	BB-2210-21
Micro Scissors Flat Handle Straight 9 mm Blades	23 cm	BB-2209-23
Micro Scissors Flat Handle Curved 9 mm Blades	23 cm	BB-2210-23

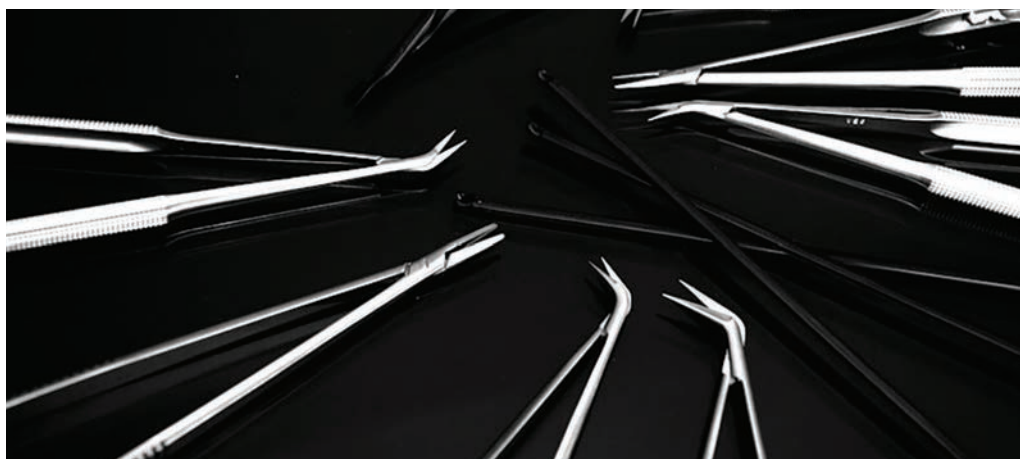

SCISSORS

Micro Scissors Round Handle 18 cm

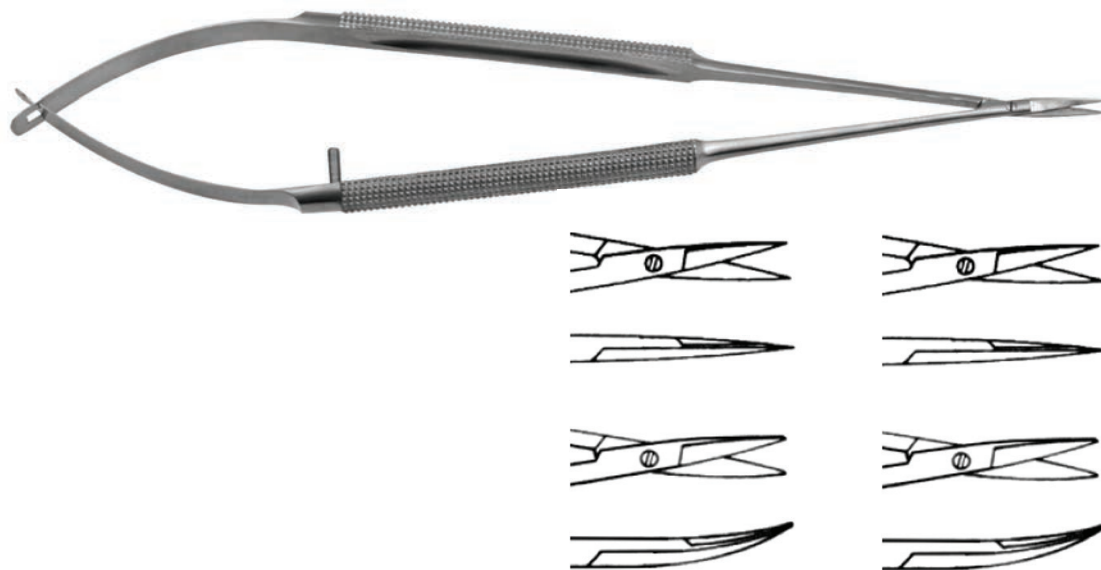

Description

- Micro Scissors Round Handle Straight 9 mm Blades
- Micro Scissors Round Handle Curved 9 mm Blades
- Micro Scissors Round Handle Straight 10 mm Blades
- Micro Scissors Round Handle Curved 10 mm Blades

Code

- BB-2200-18
- BB-2201-18
- BB-2202-18
- BB-2203-18

Titanium Micro Scissors Round Handle 18 cm

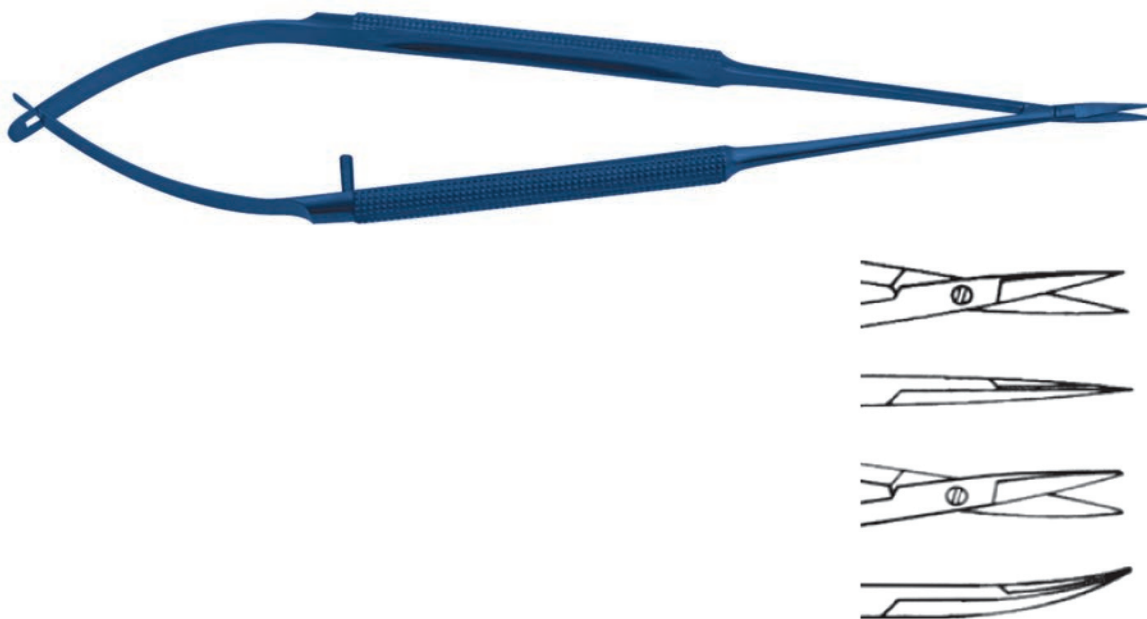

Description

- Titanium Micro Scissors Round Handle Straight 9 mm Blades
- Titanium Micro Scissors Round Handle Curved 9 mm Blades

Code

- BB-2205-18T
- BB-2206-18T

Titanium Micro Scissors Bayonet Flat Handle 23 cm

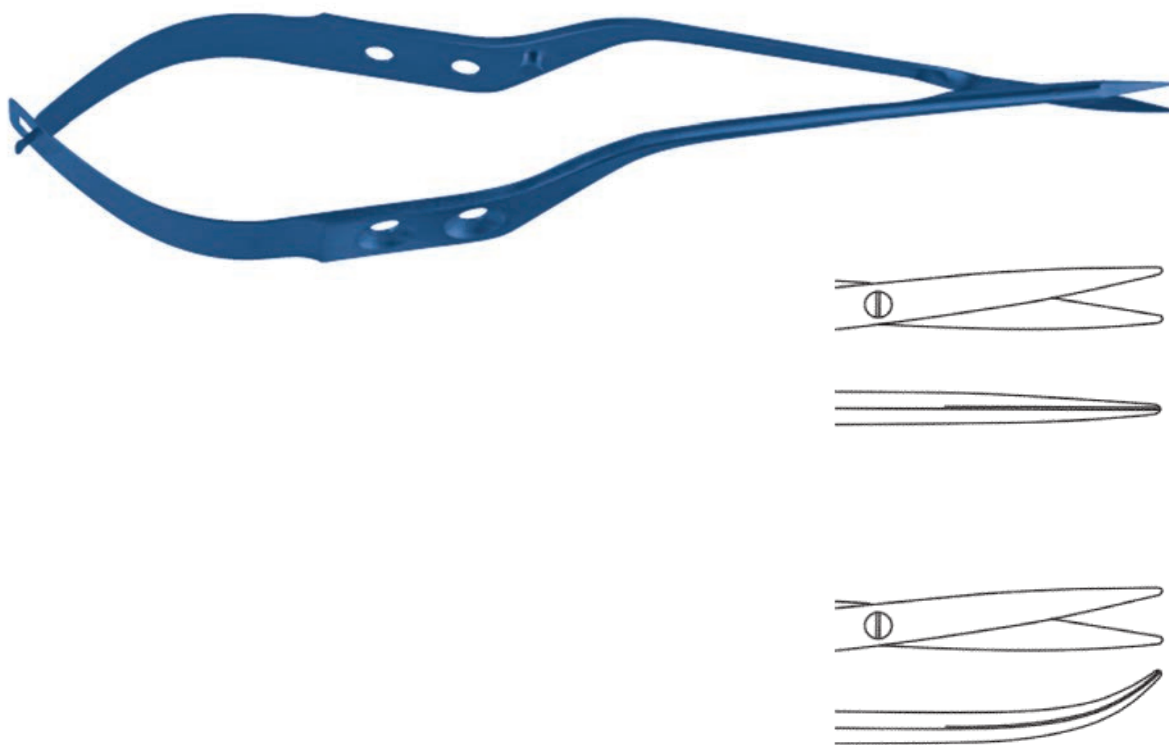

Description

- Titanium Micro Scissors Flat Handle Straight 9 mm Blades
- Titanium Micro Scissors Flat Handle Curved 9 mm Blades
- Titanium Micro Scissors Flat Handle Straight 10 mm Blades
- Titanium Micro Scissors Flat Handle Curved 10 mm Blades

Length

- 23 cm
- 23 cm
- 23 cm
- 23 cm

Code

- BB-2218-23T
- BB-2219-23T
- BB-2220-23T
- BB-2221-23T

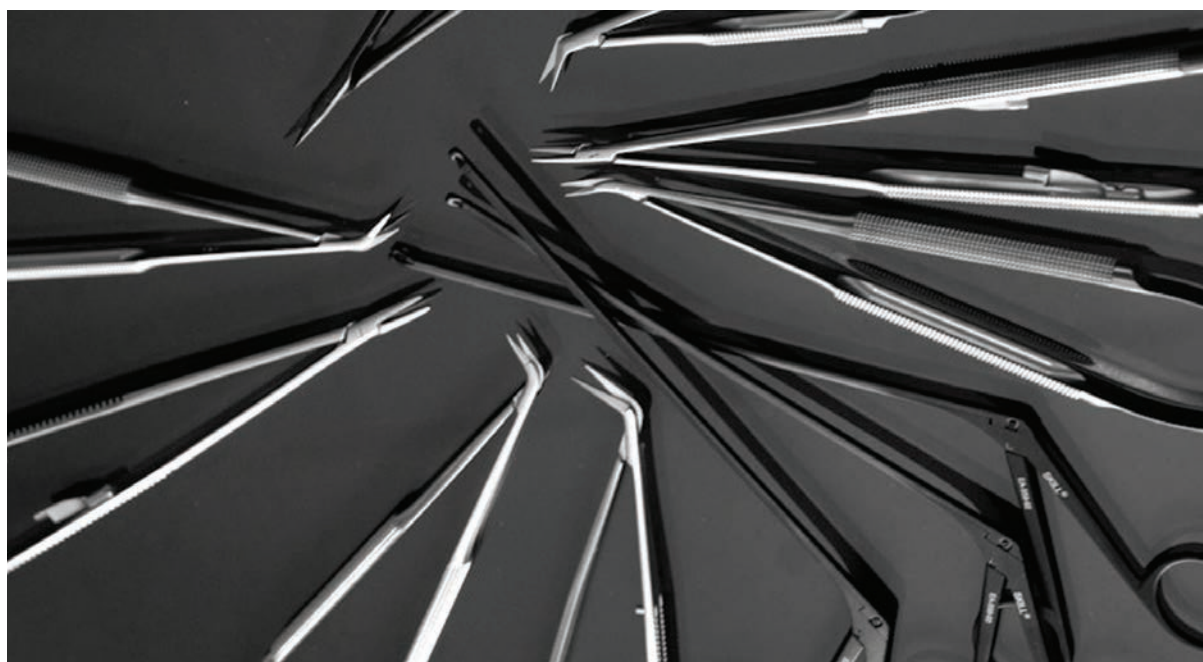

SCISSORS

SCISSORS

Micro Vascular Scissors Flat Handle 7 mm Micro Blades 10 cm

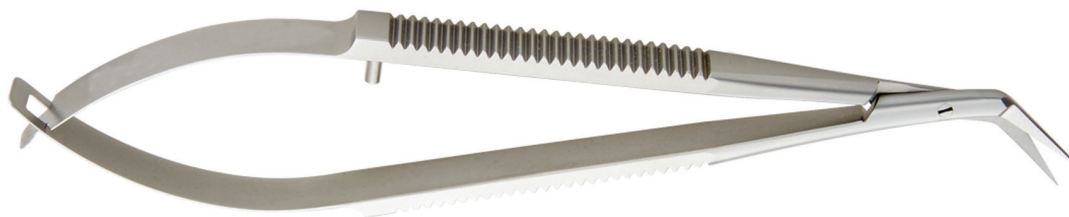

25°



45°



60°



90°



125°



Description

Micro Vascular Scissors Flat Handle 25° Angled Blades

Length

10 cm

Code

BB-8903-25

Micro Vascular Scissors Flat Handle 45° Angled Blades

10 cm

BB-8903-45

Micro Vascular Scissors Flat Handle 60° Angled Blades

10 cm

BB-8903-60

Micro Vascular Scissors Flat Handle 90° Angled Blades

10 cm

BB-8903-90

Micro Vascular Scissors Flat Handle 125°/12 Angled Blades

10 cm

BB-8903-125

Micro Vascular Scissors Flat Handle 7 mm Micro Blades 10 cm

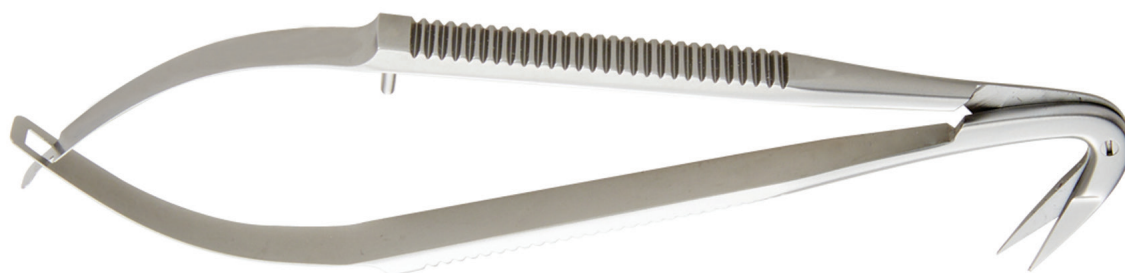

125°

Description

Micro Vascular Scissors Flat Handle 125°/12 Angled Blades

Length

10 cm

Code

BB-8903-125

Micro Vascular Scissors Flat Handle 10 mm Blades 16 cm



25°



45°



60°



90°



125°

10 mm

Description

Micro Vascular Scissors Flat Handle 25° Angled Blades
 Micro Vascular Scissors Flat Handle 45° Angled Blades
 Micro Vascular Scissors Flat Handle 60° Angled Blades
 Micro Vascular Scissors Flat Handle 90° Angled Blades
 Micro Vascular Scissors Flat Handle 125°/12 Angled Blades

Length

16 cm
 16 cm
 16 cm
 16 cm
 16 cm

Code

BB-8905-25
 BB-8905-45
 BB-8905-60
 BB-8905-90
 BB-8905-125

Micro Vascular Scissors Flat Handle 14 mm Blades 12 cm

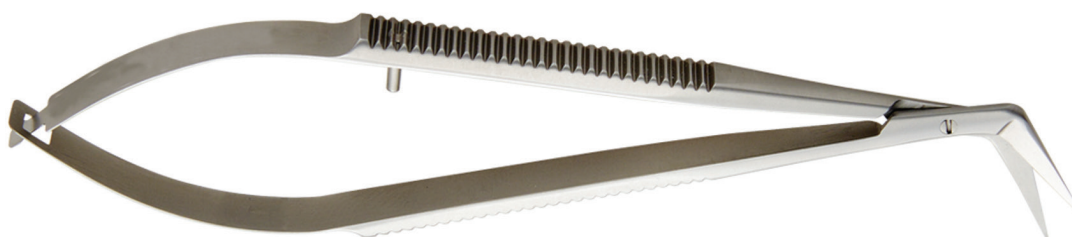

Description

Micro Vascular Scissors Flat Handle 25° Angled Blades
 Micro Vascular Scissors Flat Handle 45° Angled Blades
 Micro Vascular Scissors Flat Handle 60° Angled Blades
 Micro Vascular Scissors Flat Handle 90° Angled Blades
 Micro Vascular Scissors Flat Handle 125°/12 Angled Blades

Length

12 cm
 12 cm
 12 cm
 12 cm
 12 cm

Code

BB-8904-25
 BB-8904-45
 BB-8904-60
 BB-8904-90
 BB-8904-125

SCISSORS

Micro Vascular Scissors Flat Handle 18 cm



25°



45°



60°



90°



125°

7 mm

Description

Micro Vascular Scissors Flat Handle 25° Angled Blades

Length

18 cm

Code

BB-8906-25

Micro Vascular Scissors Flat Handle 45° Angled Blades

18 cm

BB-8906-45

Micro Vascular Scissors Flat Handle 60° Angled Blades

18 cm

BB-8906-60

Micro Vascular Scissors Flat Handle 90° Angled Blades

18 cm

BB-8906-90

Micro Vascular Scissors Flat Handle 125°/12 Angled Blades

18 cm

BB-8906-125



25°



45°



60°



90°



125°

10 mm

Description

Micro Vascular Scissors Flat Handle 25° Angled Blades

Length

18 cm

Code

BB-8907-25

Micro Vascular Scissors Flat Handle 45° Angled Blades

18 cm

BB-8907-45

Micro Vascular Scissors Flat Handle 60° Angled Blades

18 cm

BB-8907-60

Micro Vascular Scissors Flat Handle 90° Angled Blades

18 cm

BB-8907-90

Micro Vascular Scissors Flat Handle 125°/12 Angled Blades

18 cm

BB-8907-125

Micro Vascular Scissors Flat Handle 21 cm

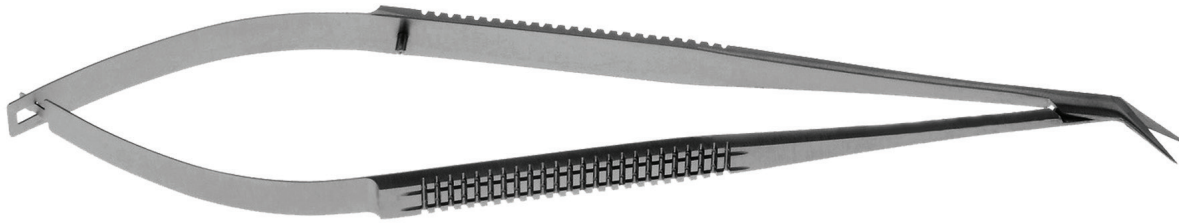

25° 45° 60° 90° 125°

7 mm

Description

- Micro Vascular Scissors Flat Handle 25° Angled Blades
- Micro Vascular Scissors Flat Handle 45° Angled Blades
- Micro Vascular Scissors Flat Handle 60° Angled Blades
- Micro Vascular Scissors Flat Handle 90° Angled Blades
- Micro Vascular Scissors Flat Handle 125°/12 Angled Blades

Length

- 21 cm
- 21 cm
- 21 cm
- 21 cm
- 21 cm

Code

- BB-8900-25
- BB-8900-45
- BB-8900-60
- BB-8900-90
- BB-8900-125



25° 45° 60° 90° 125°

10 mm

Description

- Micro Vascular Scissors Flat Handle 25° Angled Blades
- Micro Vascular Scissors Flat Handle 45° Angled Blades
- Micro Vascular Scissors Flat Handle 60° Angled Blades
- Micro Vascular Scissors Flat Handle 90° Angled Blades
- Micro Vascular Scissors Flat Handle 125°/12 Angled Blades

Length

- 21 cm
- 21 cm
- 21 cm
- 21 cm
- 21 cm

Code

- BB-8901-25
- BB-8901-45
- BB-8901-60
- BB-8901-90
- BB-8901-125

SCISSORS

Micro Vascular Scissors Round Handle 12 cm



25°



45°



60°



90°



125°



Description

Micro Vascular Scissors Round Handle 25° Angled Blades
 Micro Vascular Scissors Round Handle 45° Angled Blades
 Micro Vascular Scissors Round Handle 60° Angled Blades
 Micro Vascular Scissors Round Handle 90° Angled Blades
 Micro Vascular Scissors Round Handle 125°/12 Angled Blades

Length

12 cm
 12 cm
 12 cm
 12 cm
 12 cm

Code

BB-8909-25
 BB-8909-45
 BB-8909-60
 BB-8909-90
 BB-8909-125



25°



45°



60°



90°



125°



Description

Micro Vascular Scissors Round Handle 25° Angled Blades
 Micro Vascular Scissors Round Handle 45° Angled Blades
 Micro Vascular Scissors Round Handle 60° Angled Blades
 Micro Vascular Scissors Round Handle 90° Angled Blades
 Micro Vascular Scissors Round Handle 125°/12 Angled Blades

Length

12 cm
 12 cm
 12 cm
 12 cm
 12 cm

Code

BB-8910-25
 BB-8910-45
 BB-8910-60
 BB-8910-90
 BB-8910-125

Micro Vascular Scissors Round Handle 16 cm

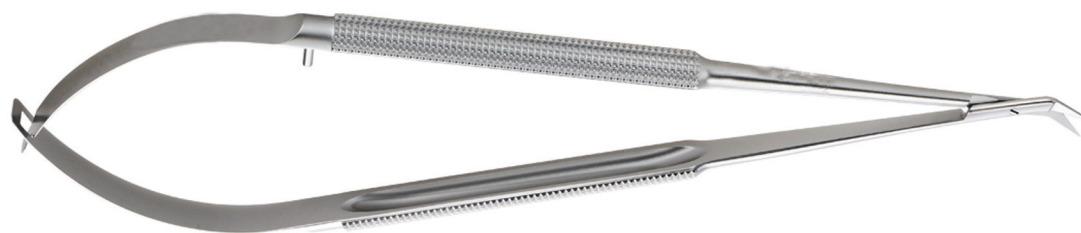

7 mm

Description

Micro Vascular Scissors Round Handle 25° Angled Blades

Length

16 cm

Code

BB-8912-25

Micro Vascular Scissors Round Handle 45° Angled Blades

16 cm

BB-8912-45

Micro Vascular Scissors Round Handle 60° Angled Blades

16 cm

BB-8912-60

Micro Vascular Scissors Round Handle 90° Angled Blades

16 cm

BB-8912-90

Micro Vascular Scissors Round Handle 125°/12 Angled Blades

16 cm

BB-8912-125



10 mm

Description

Micro Vascular Scissors Round Handle 25° Angled Blades

Length

16 cm

Code

BB-8913-25

Micro Vascular Scissors Round Handle 45° Angled Blades

16 cm

BB-8913-45

Micro Vascular Scissors Round Handle 60° Angled Blades

16 cm

BB-8913-60

Micro Vascular Scissors Round Handle 90° Angled Blades

16 cm

BB-8913-90

Micro Vascular Scissors Round Handle 125°/12 Angled Blades

16 cm

BB-8913-125

SCISSORS

Micro Vascular Scissors Round Handle 18 cm



25° 45° 60° 90° 125°

7 mm

Description	Length	Code
Micro Vascular Scissors Round Handle 25° Angled Blades	18 cm	BB-8915-25
Micro Vascular Scissors Round Handle 45° Angled Blades	18 cm	BB-8915-45
Micro Vascular Scissors Round Handle 60° Angled Blades	18 cm	BB-8915-60
Micro Vascular Scissors Round Handle 90° Angled Blades	18 cm	BB-8915-90
Micro Vascular Scissors Round Handle 125°/12 Angled Blades	18 cm	BB-8915-125



25° 45° 60° 90° 125°

10 mm

Description	Length	Code
Micro Vascular Scissors Round Handle 25° Angled Blades	18 cm	BB-8916-25
Micro Vascular Scissors Round Handle 45° Angled Blades	18 cm	BB-8916-45
Micro Vascular Scissors Round Handle 60° Angled Blades	18 cm	BB-8916-60
Micro Vascular Scissors Round Handle 90° Angled Blades	18 cm	BB-8916-90
Micro Vascular Scissors Round Handle 125°/12 Angled Blades	18 cm	BB-8916-125

Micro Vascular Scissors Round Handle 21 cm

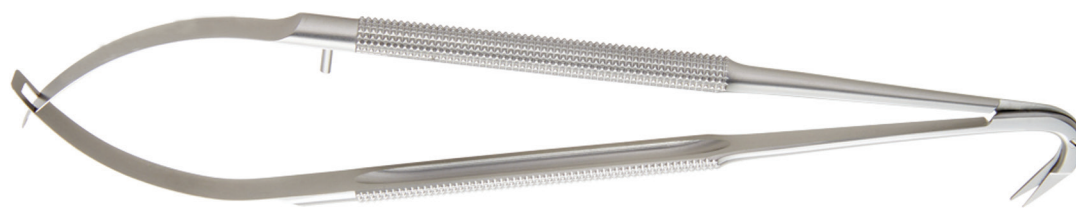

25° 45° 60° 90° 125°

7 mm

Description

Micro Vascular Scissors Round Handle 25° Angled Blades

Length

21 cm

Code

BB-8918-25

Micro Vascular Scissors Round Handle 45° Angled Blades

21 cm

BB-8918-45

Micro Vascular Scissors Round Handle 60° Angled Blades

21 cm

BB-8918-60

Micro Vascular Scissors Round Handle 90° Angled Blades

21 cm

BB-8918-90

Micro Vascular Scissors Round Handle 125°/12 Angled Blades

21 cm

BB-8918-125



25° 45° 60° 90° 125°

10 mm

Description

Micro Vascular Scissors Round Handle 25° Angled Blades

Length

21 cm

Code

BB-8919-25

Micro Vascular Scissors Round Handle 45° Angled Blades

21 cm

BB-8919-45

Micro Vascular Scissors Round Handle 60° Angled Blades

21 cm

BB-8919-60

Micro Vascular Scissors Round Handle 90° Angled Blades

21 cm

BB-8919-90

Micro Vascular Scissors Round Handle 125°/12 Angled Blades

21 cm

BB-8919-125

Jacobson Micro Scissors Flat Handle Bayonet



Description	Length	Code
Jacobson Micro Scissors Flat Handle Bayonet 14 mm Blade Straight	18 cm	BB-9801-18
Jacobson Micro Scissors Flat Handle Bayonet 14 mm Blade Straight	21 cm	BB-9801-21
Jacobson Micro Scissors Flat Handle Bayonet 14 mm Blade Straight	22 cm	BB-9801-22
Jacobson Micro Scissors Flat Handle Bayonet 14 mm Blade Straight	23 cm	BB-9801-23

Description	Length	Code
Jacobson Micro Scissors Flat Handle Bayonet 14 mm Blade Curved	18 cm	BB-9802-18
Jacobson Micro Scissors Flat Handle Bayonet 14 mm Blade Curved	21 cm	BB-9802-21
Jacobson Micro Scissors Flat Handle Bayonet 14 mm Blade Curved	22 cm	BB-9802-22
Jacobson Micro Scissors Flat Handle Bayonet 14 mm Blade Curved	23 cm	BB-9802-23

Jacobson Micro Scissors Flat Handle Bayonet

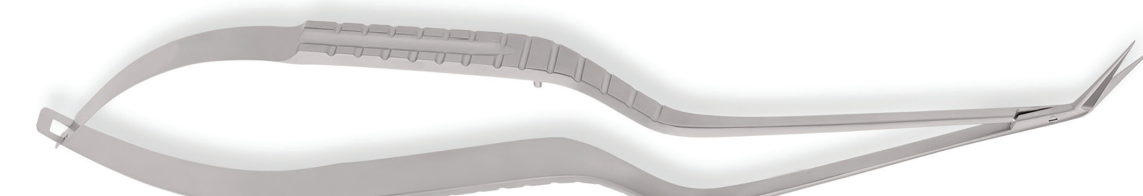

Description	Length	Code
Jacobson Micro Scissors Flat Handle Bayonet 12 mm 45°	18 cm	BB-9803-18
Jacobson Micro Scissors Flat Handle Bayonet 12 mm 45°	21 cm	BB-9803-21
Jacobson Micro Scissors Flat Handle Bayonet 12 mm 45°	22 cm	BB-9803-22
Jacobson Micro Scissors Flat Handle Bayonet 12 mm 45°	23 cm	BB-9803-23



Jacobson Micro Scissors Flat Handle Bayonet



Description

Jacobson Micro Scissors Flat Handle Bayonet 12 mm 125°

Jacobson Micro Scissors Flat Handle Bayonet 12 mm 125°

Jacobson Micro Scissors Flat Handle Bayonet 12 mm 125°

Jacobson Micro Scissors Flat Handle Bayonet 12 mm 125°

Length

18 cm

21 cm

22 cm

23 cm

Code

BB-9804-18

BB-9804-21

BB-9804-22

BB-9804-23



SCISSORS

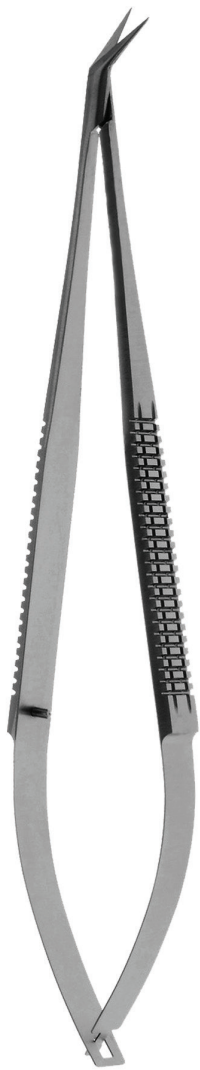
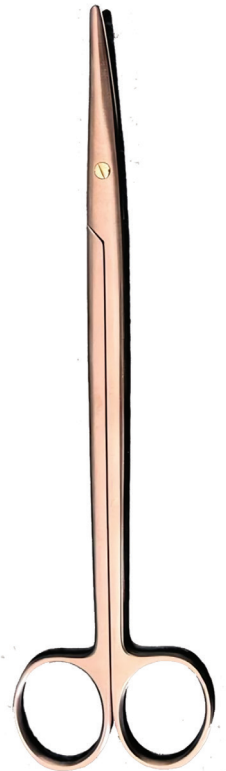

SKILL[®]

Surgical Instruments

MICRO FORCEPS

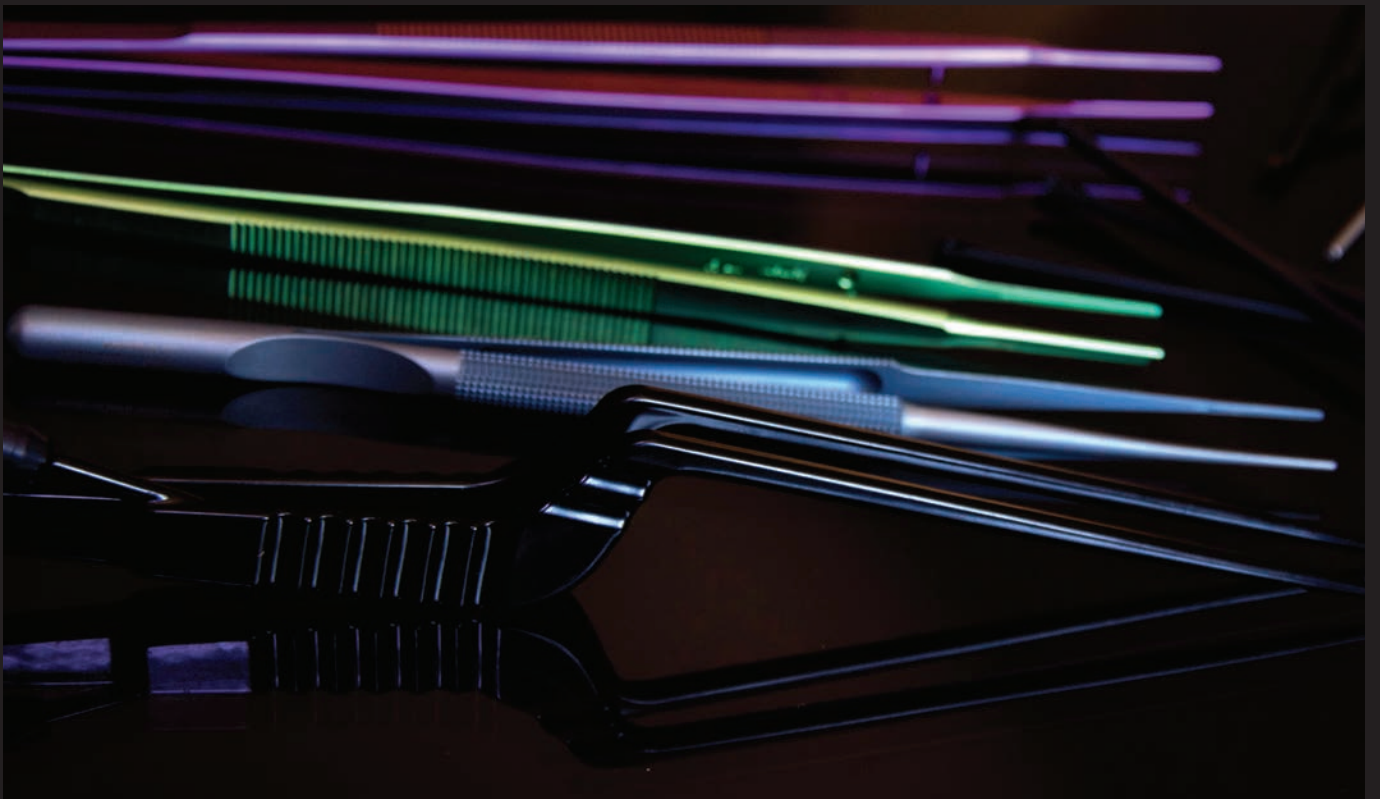



Index

Micro Forceps

Titanium Micro Ring Forceps Round Handle Counterbalance	116
Micro Ring Forceps Round Handle Counterbalance	116
Titanium Micro Ring Forceps Round Handle	117
Micro Ring Forceps Round Handle	117
Titanium Micro Forceps Round Handle Counterbalance	118
Micro Forceps Round Handle Counterbalance	118
Titanium Micro Forceps Round Handle	119
Micro Forceps Round Handle	120
Titanium Micro DeBakey Forceps Round Handle Counterbalance	121
Micro DeBakey Forceps Round Handle Counterbalance	121
Titanium Micro DeBakey Forceps Round Handle	122
Micro DeBakey Forceps Round Handle	122
Titanium Gerald DeBakey Forceps Flat Handle	123
Gerald DeBakey Forceps Flat Handle	123
Titanium Gerald Forceps Flat Handle	124
Gerald Forceps Flat Handle	124
Titanium Gerald Ring Forceps Flat Handle	125
Gerald Ring Forceps Flat Handle	125
Resano Forceps Multi Toothed 230 mm	125
Adson Forceps	126-127
Bonneys Forceps Toothed 18 cm	128
Gillies Forceps Toothed 15 cm	129
Titanium Gillies Forceps Toothed 15 cm	129
McIndoe Forceps Plain 15 cm	129
Titanium McIndoe Forceps Plain 15 cm	130
Russian Forceps	130
Treves Forceps Toothed 15 cm	131
DeBakey Vascular Forceps	131-132
Cushing Forceps TC Straight	132

Titanium Micro Ring Forceps Round Handle Counterbalance



**Straight
Gerade
1 x 0.5 mm**



**Curved
Gerade
1 x 0.5 mm**



**Straight
Gerade
2 x 1 mm**



**Curved
Gerade
2 x 1 mm**



Description

Description	Length	Code
Titanium Micro Ring Forceps Round Handle 1 x 0.5 mm	15 cm	BD-1310-15T
Titanium Micro Ring Forceps Round Handle 2 x 1.0 mm	15 cm	BD-1311-15T
Titanium Micro Ring Forceps Round Handle 1 x 0.5 mm	18 cm	BD-1310-18T
Titanium Micro Ring Forceps Round Handle 2 x 1.0 mm	18 cm	BD-1311-18T
Titanium Micro Ring Forceps Round Handle 1 x 0.5 mm	21 cm	BD-1310-21T
Titanium Micro Ring Forceps Round Handle 2 x 1.0 mm	21 cm	BD-1311-21T
Titanium Micro Ring Forceps Round Handle 1 x 0.5 mm	23 cm	BD-1310-23T
Titanium Micro Ring Forceps Round Handle 2 x 1.0 mm	23 cm	BD-1311-23T

Micro Ring Forceps Round Handle Counterbalance



**Straight
Gerade
1 x 0.5 mm**



**Curved
Gerade
1 x 0.5 mm**



**Straight
Gerade
2 x 1 mm**



**Curved
Gerade
2 x 1 mm**



Description

Description	Length	Code
Micro Ring Forceps Round Handle 1 x 0.5 mm	15 cm	BD-1310-15
Micro Ring Forceps Round Handle 2 x 1.0 mm	15 cm	BD-1311-15
Micro Ring Forceps Round Handle 1 x 0.5 mm	18 cm	BD-1310-18
Micro Ring Forceps Round Handle 2 x 1.0 mm	18 cm	BD-1311-18
Micro Ring Forceps Round Handle 1 x 0.5 mm	21 cm	BD-1310-21
Micro Ring Forceps Round Handle 2 x 1.0 mm	21 cm	BD-1311-21
Micro Ring Forceps Round Handle 1 x 0.5 mm	23 cm	BD-1310-23
Micro Ring Forceps Round Handle 2 x 1.0 mm	23 cm	BD-1311-23

Titanium Micro Ring Forceps Round Handle



Straight
Gerade
1 x 0.5 mm



Curved
Gerade
1 x 0.5 mm



Straight
Gerade
2 x 1 mm



Curved
Gerade
2 x 1 mm



Description

Titanium Micro Ring Forceps Round Handle	1 x 0.5 mm
Titanium Micro Ring Forceps Round Handle	2 x 1.0 mm
Titanium Micro Ring Forceps Round Handle	1 x 0.5 mm
Titanium Micro Ring Forceps Round Handle	2 x 1.0 mm
Titanium Micro Ring Forceps Round Handle	1 x 0.5 mm
Titanium Micro Ring Forceps Round Handle	2 x 1.0 mm
Titanium Micro Ring Forceps Round Handle	1 x 0.5 mm
Titanium Micro Ring Forceps Round Handle	2 x 1.0 mm

Length

15 cm
15 cm
18 cm
18 cm
21 cm
21 cm
23 cm
23 cm

Code

BD-1335-15T
BD-1336-15T
BD-1335-18T
BD-1336-18T
BD-1335-21T
BD-1336-21T
BD-1335-23T
BD-1336-23T

Micro Ring Forceps Round Handle



Straight
Gerade
1 x 0.5 mm



Curved
Gerade
1 x 0.5 mm



Straight
Gerade
2 x 1 mm



Curved
Gerade
2 x 1 mm



Description

Micro Ring Forceps Round Handle	1 x 0.5 mm
Micro Ring Forceps Round Handle	2 x 1.0 mm
Micro Ring Forceps Round Handle	1 x 0.5 mm
Micro Ring Forceps Round Handle	2 x 1.0 mm
Micro Ring Forceps Round Handle	1 x 0.5 mm
Micro Ring Forceps Round Handle	2 x 1.0 mm
Micro Ring Forceps Round Handle	1 x 0.5 mm
Micro Ring Forceps Round Handle	2 x 1.0 mm

Length

15 cm
15 cm
18 cm
18 cm
21 cm
21 cm
23 cm
23 cm

Code

BD-1335-15
BD-1336-15
BD-1335-18
BD-1336-18
BD-1335-21
BD-1336-21
BD-1335-23
BD-1336-23

Titanium Micro Forceps Round Handle Counterbalance



Straight Gerade
0.3 mm



Curved Gerade
0.3 mm



Straight Gerade
0.4 mm



Curved Gerade
0.4 mm



Straight Gerade
0.7 mm



Curved Gerade
0.7 mm



Straight Gerade
0.8 mm



Curved Gerade
0.8 mm



Description

Description	Length	Code
Titanium Micro Forceps Round Handle 0.3 mm Diamond Dust Insert	15 cm	BD-1312-15T
Titanium Micro Forceps Round Handle 0.4 mm Diamond Dust Insert	15 cm	BD-1313-15T
Titanium Micro Forceps Round Handle 0.7 mm Diamond Dust Insert	15 cm	BD-1314-15T
Titanium Micro Forceps Round Handle 0.8 mm Diamond Dust Insert	15 cm	BD-1315-15T
Titanium Micro Forceps Round Handle 0.3 mm Diamond Dust Insert	18 cm	BD-1312-18T
Titanium Micro Forceps Round Handle 0.4 mm Diamond Dust Insert	18 cm	BD-1313-18T
Titanium Micro Forceps Round Handle 0.7 mm Diamond Dust Insert	18 cm	BD-1314-18T
Titanium Micro Forceps Round Handle 0.8 mm Diamond Dust Insert	18 cm	BD-1315-18T
Titanium Micro Forceps Round Handle 0.3 mm Diamond Dust Insert	21 cm	BD-1312-21T
Titanium Micro Forceps Round Handle 0.4 mm Diamond Dust Insert	21 cm	BD-1313-21T
Titanium Micro Forceps Round Handle 0.7 mm Diamond Dust Insert	21 cm	BD-1314-21T
Titanium Micro Forceps Round Handle 0.8 mm Diamond Dust Insert	21 cm	BD-1315-21T

Micro Forceps Round Handle Counterbalance



Straight Gerade
0.3 mm



Curved Gerade
0.3 mm



Straight Gerade
0.4 mm



Curved Gerade
0.4 mm



Straight Gerade
0.7 mm



Curved Gerade
0.7 mm



Straight Gerade
0.8 mm



Curved Gerade
0.8 mm



Description

Description	Length	Code
Micro Forceps Round Handle 0.3 mm Diamond Dust Insert	15 cm	BD-1312-15
Micro Forceps Round Handle 0.4 mm Diamond Dust Insert	15 cm	BD-1313-15
Micro Forceps Round Handle 0.7 mm Diamond Dust Insert	15 cm	BD-1314-15
Micro Forceps Round Handle 0.8 mm Diamond Dust Insert	15 cm	BD-1315-15
Micro Forceps Round Handle 0.3 mm Diamond Dust Insert	18 cm	BD-1312-18
Micro Forceps Round Handle 0.4 mm Diamond Dust Insert	18 cm	BD-1313-18
Micro Forceps Round Handle 0.7 mm Diamond Dust Insert	18 cm	BD-1314-18
Micro Forceps Round Handle 0.8 mm Diamond Dust Insert	18 cm	BD-1315-18
Micro Forceps Round Handle 0.3 mm Diamond Dust Insert	21 cm	BD-1312-21
Micro Forceps Round Handle 0.4 mm Diamond Dust Insert	21 cm	BD-1313-21
Micro Forceps Round Handle 0.7 mm Diamond Dust Insert	21 cm	BD-1314-21
Micro Forceps Round Handle 0.8 mm Diamond Dust Insert	21 cm	BD-1315-21

Titanium Micro Forceps Round Handle



**Straight
Gerade
0.3 mm**



**Curved
Gerade
0.3 mm**



**Straight
Gerade
0.4 mm**



**Curved
Gerade
0.4 mm**



**Straight
Gerade
0.7 mm**



**Curved
Gerade
0.7 mm**



**Straight
Gerade
0.8 mm**



**Curved
Gerade
0.8 mm**



Description

Titanium Micro Forceps Round Handle	0.3 mm Diamond Dust Insert	15 cm	BD-1338-15T
Titanium Micro Forceps Round Handle	0.4 mm Diamond Dust Insert	15 cm	BD-1339-15T
Titanium Micro Forceps Round Handle	0.7 mm Diamond Dust Insert	15 cm	BD-1340-15T
Titanium Micro Forceps Round Handle	0.8 mm Diamond Dust Insert	15 cm	BD-1341-15T
Titanium Micro Forceps Round Handle	0.3 mm Diamond Dust Insert	18 cm	BD-1338-18T
Titanium Micro Forceps Round Handle	0.4 mm Diamond Dust Insert	18 cm	BD-1339-18T
Titanium Micro Forceps Round Handle	0.7 mm Diamond Dust Insert	18 cm	BD-1340-18T
Titanium Micro Forceps Round Handle	0.8 mm Diamond Dust Insert	18 cm	BD-1341-18T
Titanium Micro Forceps Round Handle	0.3 mm Diamond Dust Insert	21 cm	BD-1338-21T
Titanium Micro Forceps Round Handle	0.4 mm Diamond Dust Insert	21 cm	BD-1339-21T
Titanium Micro Forceps Round Handle	0.7 mm Diamond Dust Insert	21 cm	BD-1340-21T
Titanium Micro Forceps Round Handle	0.8 mm Diamond Dust Insert	21 cm	BD-1341-21T

Length

Code



MICRO FORCEPS

Micro Forceps Round Handle



Straight
Gerade
0.3 mm

Curved
Gerade
0.3 mm

Straight
Gerade
0.4 mm

Curved
Gerade
0.4 mm

Straight
Gerade
0.7 mm

Curved
Gerade
0.7 mm

Straight
Gerade
0.8 mm

Curved
Gerade
0.8 mm



Description

Micro Forceps Round Handle
Micro Forceps Round Handle
Micro Forceps Round Handle
Micro Forceps Round Handle
Micro Forceps Round Handle
Micro Forceps Round Handle
Micro Forceps Round Handle
Micro Forceps Round Handle
Micro Forceps Round Handle
Micro Forceps Round Handle
Micro Forceps Round Handle
Micro Forceps Round Handle

0.3 mm Diamond Dust Insert
0.4 mm Diamond Dust Insert
0.7 mm Diamond Dust Insert
0.8 mm Diamond Dust Insert
0.3 mm Diamond Dust Insert
0.4 mm Diamond Dust Insert
0.7 mm Diamond Dust Insert
0.8 mm Diamond Dust Insert
0.3 mm Diamond Dust Insert
0.4 mm Diamond Dust Insert
0.7 mm Diamond Dust Insert
0.8 mm Diamond Dust Insert

Length

15 cm
15 cm
15 cm
15 cm
18 cm
18 cm
18 cm
18 cm
21 cm
21 cm
21 cm
21 cm

Code

BD-1338-15
BD-1339-15
BD-1340-15
BD-1341-15
BD-1338-18
BD-1339-18
BD-1340-18
BD-1341-18
BD-1338-21
BD-1339-21
BD-1340-21
BD-1341-21



Titanium Micro DeBakey Forceps Round Handle Counterbalance



Straight Gerade
1.0 mm



Curved Gerade
1.0 mm



Straight Gerade
1.3 mm



Curved Gerade
1.3 mm



Straight Gerade
1.5 mm



Curved Gerade
1.5 mm



Description	Length	Code
Titanium Micro DeBakey Forceps Round Handle 1 mm	15 cm	BD-1350-15T
Titanium Micro DeBakey Forceps Round Handle 1.3 mm	15 cm	BD-1351-15T
Titanium Micro DeBakey Forceps Round Handle 1.5 mm	15 cm	BD-1352-15T
Titanium Micro DeBakey Forceps Round Handle 1 mm	18 cm	BD-1350-18T
Titanium Micro DeBakey Forceps Round Handle 1.3 mm	18 cm	BD-1351-18T
Titanium Micro DeBakey Forceps Round Handle 1.5 mm	18 cm	BD-1352-18T
Titanium Micro DeBakey Forceps Round Handle 1 mm	21 cm	BD-1350-21T
Titanium Micro DeBakey Forceps Round Handle 1.3 mm	21 cm	BD-1351-21T
Titanium Micro DeBakey Forceps Round Handle 1.5 mm	21 cm	BD-1352-21T
Titanium Micro DeBakey Forceps Round Handle 1 mm	23 cm	BD-1350-23T
Titanium Micro DeBakey Forceps Round Handle 1.3 mm	23 cm	BD-1351-23T
Titanium Micro DeBakey Forceps Round Handle 1.5 mm	23 cm	BD-1352-23T

Micro DeBakey Forceps Round Handle Counterbalance



Straight Gerade
1.0 mm



Curved Gerade
1.0 mm



Straight Gerade
1.3 mm



Curved Gerade
1.3 mm



Straight Gerade
1.5 mm



Curved Gerade
1.5 mm



Description	Length	Code
Micro DeBakey Forceps Round Handle 1 mm	15 cm	BD-1350-15
Micro DeBakey Forceps Round Handle 1.3 mm	15 cm	BD-1351-15
Micro DeBakey Forceps Round Handle 1.5 mm	15 cm	BD-1352-15
Micro DeBakey Forceps Round Handle 1 mm	18 cm	BD-1350-18
Micro DeBakey Forceps Round Handle 1.3 mm	18 cm	BD-1351-18
Micro DeBakey Forceps Round Handle 1.5 mm	18 cm	BD-1352-18
Micro DeBakey Forceps Round Handle 1 mm	21 cm	BD-1350-21
Micro DeBakey Forceps Round Handle 1.3 mm	21 cm	BD-1351-21
Micro DeBakey Forceps Round Handle 1.5 mm	21 cm	BD-1352-21
Micro DeBakey Forceps Round Handle 1 mm	23 cm	BD-1350-23
Micro DeBakey Forceps Round Handle 1.3 mm	23 cm	BD-1351-23
Micro DeBakey Forceps Round Handle 1.5 mm	23 cm	BD-1352-23

Titanium Micro DeBakey Forceps Round Handle



Straight Gerade
1.0 mm



Curved Gerade
1.0 mm



Straight Gerade
1.3 mm



Curved Gerade
1.3 mm



Straight Gerade
1.5 mm



Curved Gerade
1.5 mm



Description		Length	Code
Titanium Micro DeBakey Forceps Round Handle	1 mm	15 cm	BD-1353-15T
Titanium Micro DeBakey Forceps Round Handle	1.3 mm	15 cm	BD-1354-15T
Titanium Micro DeBakey Forceps Round Handle	1.5 mm	15 cm	BD-1355-15T
Titanium Micro DeBakey Forceps Round Handle	1 mm	18 cm	BD-1353-18T
Titanium Micro DeBakey Forceps Round Handle	1.3 mm	18 cm	BD-1354-18T
Titanium Micro DeBakey Forceps Round Handle	1.5 mm	18 cm	BD-1355-18T
Titanium Micro DeBakey Forceps Round Handle	1 mm	21 cm	BD-1353-21T
Titanium Micro DeBakey Forceps Round Handle	1.3 mm	21 cm	BD-1354-21T
Titanium Micro DeBakey Forceps Round Handle	1.5 mm	21 cm	BD-1355-21T
Titanium Micro DeBakey Forceps Round Handle	1 mm	23 cm	BD-1353-23T
Titanium Micro DeBakey Forceps Round Handle	1.3 mm	23 cm	BD-1354-23T
Titanium Micro DeBakey Forceps Round Handle	1.5 mm	23 cm	BD-1355-23T

Micro DeBakey Forceps Round Handle



Straight Gerade
1.0 mm



Curved Gerade
1.0 mm



Straight Gerade
1.3 mm



Curved Gerade
1.3 mm



Straight Gerade
1.5 mm



Curved Gerade
1.5 mm



Description		Length	Code
Micro DeBakey Forceps Round Handle	1 mm	15 cm	BD-1353-15
Micro DeBakey Forceps Round Handle	1.3 mm	15 cm	BD-1354-15
Micro DeBakey Forceps Round Handle	1.5 mm	15 cm	BD-1355-15
Micro DeBakey Forceps Round Handle	1 mm	18 cm	BD-1353-18
Micro DeBakey Forceps Round Handle	1.3 mm	18 cm	BD-1354-18
Micro DeBakey Forceps Round Handle	1.5 mm	18 cm	BD-1355-18
Micro DeBakey Forceps Round Handle	1 mm	21 cm	BD-1353-21
Micro DeBakey Forceps Round Handle	1.3 mm	21 cm	BD-1354-21
Micro DeBakey Forceps Round Handle	1.5 mm	21 cm	BD-1355-21
Micro DeBakey Forceps Round Handle	1 mm	23 cm	BD-1353-23
Micro DeBakey Forceps Round Handle	1.3 mm	23 cm	BD-1354-23
Micro DeBakey Forceps Round Handle	1.5 mm	23 cm	BD-1355-23

Titanium Gerald DeBakey Forceps Flat Handle



Description	Length	Code
Titanium Gerald DeBakey Forceps Flat Handle 1 mm Jaw	18 cm	BD-009-18T
Titanium Gerald DeBakey Forceps Flat Handle 1 mm Jaw	21 cm	BD-009-21T
Titanium Gerald DeBakey Forceps Flat Handle 1 mm Jaw	23 cm	BD-009-23T

Gerald DeBakey Forceps Flat Handle



Description	Length	Code
Gerald DeBakey Forceps Flat Handle 1 mm Jaw	18 cm	BD-009-18
Gerald DeBakey Forceps Flat Handle 1 mm Jaw	21 cm	BD-009-21
Gerald DeBakey Forceps Flat Handle 1 mm Jaw	23 cm	BD-009-23

Titanium Gerald Forceps Flat Handle



Description	Length	Code
Titanium Gerald Forceps 1 mm Jaw Flat Handle	18 cm	BD-007-18T
Titanium Gerald Forceps 1 mm Jaw Flat Handle	21 cm	BD-007-21T
Titanium Gerald Forceps 1 mm Jaw Flat Handle	23 cm	BD-007-23T

Gerald Forceps Flat Handle

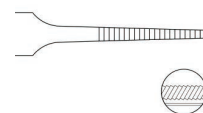

Description

Gerald Forceps 1 mm Jaw Flat Handle
 Gerald Forceps 1 mm Jaw Flat Handle
 Gerald Forceps 1 mm Jaw Flat Handle

Length

18 cm
 21 cm
 23 cm

Code

BD-007-18
 BD-007-21
 BD-007-23

Titanium Gerald Ring Forceps Flat Handle

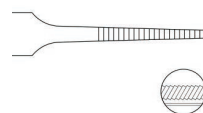

Description

Titanium Gerald Ring Forceps 1 x 0.5 mm Flat Handle
 Titanium Gerald Ring Forceps 1 x 0.5 mm Flat Handle

Length

18 cm
 21 cm

Code

BD-010-18T
 BD-010-21T



Gerald Ring Forceps Flat Handle



Straight
1 x 0.5 mm



Curved
1 x 0.5 mm



Description

Gerald Ring Forceps 1 x 0.5 mm Flat Handle
Gerald Ring Forceps 1 x 0.5 mm Flat Handle

Length

18 cm
21 cm

Code

BD-010-18
BD-010-21

Gerald Forceps Straight TC



Description

Gerald Forceps Straight TC
Gerald Forceps Straight TC

Length

18 cm
23 cm

Code

BD-070-18
BD-070-23

Resano Forceps Multi Toothed



Description

Resano Forceps Multi Toothed
Resano Forceps Multi Toothed
Resano Forceps Multi Toothed
Resano Forceps Multi Toothed

Length

18 cm
20 cm
23 cm
30 cm

Code

BD-190-18
BD-190-20
BD-190-23
BD-190-30

Adson Brown Forceps



Description

Adson Brown Forceps 7 x 7 toothed
Adson Brown Forceps 7 x 7 toothed

Length

12 cm
15 cm

Code

BD-191-12
BD-191-15

Micro Adson Forceps Plain

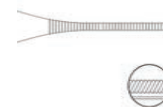

Description

Micro Adson Forceps Plain
Micro Adson Forceps Plain

Length

12 cm
15 cm

Code

BD-044-12
BD-044-15

Micro Adson Forceps Toothed

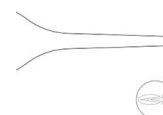

Description

Micro Adson Forceps Toothed
Micro Adson Forceps Toothed

Length

12 cm
15 cm

Code

BD-043-12
BD-043-15

Micro Adson Forceps Toothed with Hole

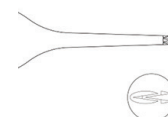

Description

Micro Adson Forceps Toothed with Hole
 Micro Adson Forceps Toothed with Hole

Length

12 cm
 15 cm

Code

BD-045-12
 BD-045-15

Adson Forceps Plain

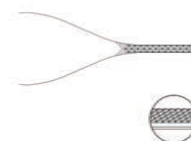

Description

Adson Forceps Plain
 Adson Forceps Plain

Length

12 cm
 15 cm

Code

BD-042-12
 BD-042-15

Adson Forceps Toothed



Description

Adson Forceps Toothed
 Adson Forceps Toothed

Length

12 cm
 15 cm

Code

BD-041-12
 BD-041-15

MICRO FORCEPS

Titanium Adson Forceps Plain

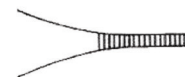

Description

Titanium Adson Forceps Plain
 Titanium Adson Forceps Plain

Length

12 cm
 15 cm

Code

BD-042-12T
 BD-042-15T

Titanium Adson Forceps Toothed



Description

Titanium Adson Forceps Toothed
 Titanium Adson Forceps Toothed

Length

12 cm
 15 cm

Code

BD-043-12T
 BD-043-15T

Bonneys Forceps Toothed 18 cm

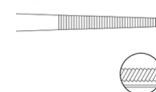

Description

Bonneys Forceps Toothed

Length

18 cm

Code

BD-175-18

Gillies Forceps Toothed 15 cm



Description

Gillies Forceps Toothed

Length

15 cm

Code

BD-152-15

Titanium Gillies Forceps Toothed 15 cm



1 x 2

Description

Titanium Gillies Forceps Toothed

Length

15 cm

Code

BD-152-15T

McIndoe Forceps Plain 15 cm



Description

McIndoe Forceps Plain

Length

15 cm

Code

BD-050-15

MICRO FORCEPS

Titanium McIndoe Forceps Plain 15 cm

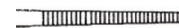

Description	Length	Code
Titanium McIndoe Forceps Plain	15 cm	BD-050-15T

Russian Forceps



Description	Length	Code
Russian Forceps	15 cm	BD-084-15
Russian Forceps	20 cm	BD-084-20
Russian Forceps	25 cm	BD-084-25
Russian Forceps	30 cm	BD-084-30



Treves Forceps Toothed 15 cm



1 x 2



Description

Treves Forceps Toothed

Length

15 cm

Code

BD-180-15

DeBakey Vascular Forceps



Angled DeBakey Forceps



1.5 mm



2 mm



2.4 mm



2.8 mm

Description

DeBakey Vascular Forceps	1.5 mm Tip
DeBakey Vascular Forceps	1.5 mm Tip
DeBakey Vascular Forceps	1.5 mm Tip
DeBakey Vascular Forceps	1.5 mm Tip
DeBakey Vascular Forceps	2 mm Tip
DeBakey Vascular Forceps	2 mm Tip
DeBakey Vascular Forceps	2 mm Tip
DeBakey Vascular Forceps	2 mm Tip
DeBakey Vascular Forceps	2.4 mm Tip
DeBakey Vascular Forceps	2.4 mm Tip
DeBakey Vascular Forceps	2.4 mm Tip
DeBakey Vascular Forceps	2.4 mm Tip
DeBakey Vascular Forceps	2.8 mm Tip
DeBakey Vascular Forceps	2.8 mm Tip
DeBakey Vascular Forceps	2.8 mm Tip
DeBakey Vascular Forceps	2.8 mm Tip

Length

16 cm
20 cm
24 cm
30 cm
16 cm
20 cm
24 cm
30 cm
16 cm
20 cm
24 cm
30 cm
16 cm
20 cm
24 cm
30 cm

Code

BD-210-16
BD-210-20
BD-210-24
BD-210-30
BD-208-16
BD-208-20
BD-208-24
BD-208-30
BD-206-16
BD-206-20
BD-206-24
BD-206-30
BD-204-16
BD-204-20
BD-204-24
BD-204-30

Titanium DeBakey Vascular Forceps



Angled DeBakey Forceps



1.5 mm



2 mm



2.4 mm



2.8 mm

Description	Length	Code
Titanium DeBakey Vascular Forceps 1.5 mm Tip	16 cm	BD-210-16T
Titanium DeBakey Vascular Forceps 1.5 mm Tip	20 cm	BD-210-20T
Titanium DeBakey Vascular Forceps 1.5 mm Tip	24 cm	BD-210-24T
Titanium DeBakey Vascular Forceps 1.5 mm Tip	30 cm	BD-210-30T
Titanium DeBakey Vascular Forceps 2 mm Tip	16 cm	BD-208-16T
Titanium DeBakey Vascular Forceps 2 mm Tip	20 cm	BD-208-20T
Titanium DeBakey Vascular Forceps 2 mm Tip	24 cm	BD-208-24T
Titanium DeBakey Vascular Forceps 2 mm Tip	30 cm	BD-208-30T
Titanium DeBakey Vascular Forceps 2.4 mm Tip	16 cm	BD-206-16T
Titanium DeBakey Vascular Forceps 2.4 mm Tip	20 cm	BD-206-20T
Titanium DeBakey Vascular Forceps 2.4 mm Tip	24 cm	BD-206-24T
Titanium DeBakey Vascular Forceps 2.4 mm Tip	30 cm	BD-206-30T
Titanium DeBakey Vascular Forceps 2.8 mm Tip	16 cm	BD-204-16T
Titanium DeBakey Vascular Forceps 2.8 mm Tip	20 cm	BD-204-20T
Titanium DeBakey Vascular Forceps 2.8 mm Tip	24 cm	BD-204-24T
Titanium DeBakey Vascular Forceps 2.8 mm Tip	30 cm	BD-204-30T

Cushing Forceps TC Straight



Description	Length	Code
Cushing Forceps TC Straight	18 cm	BD-1818-18

SKILL[®]

Surgical Instruments

MICRO NEEDLE HOLDERS

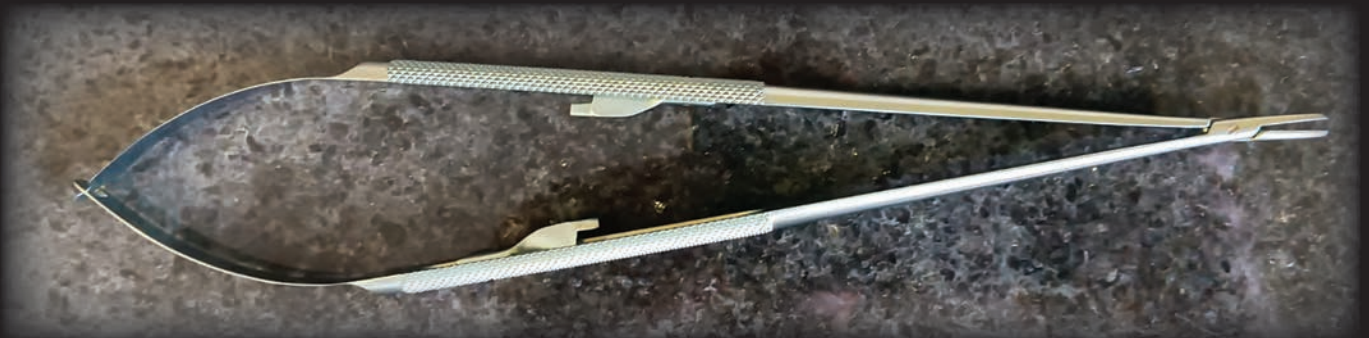

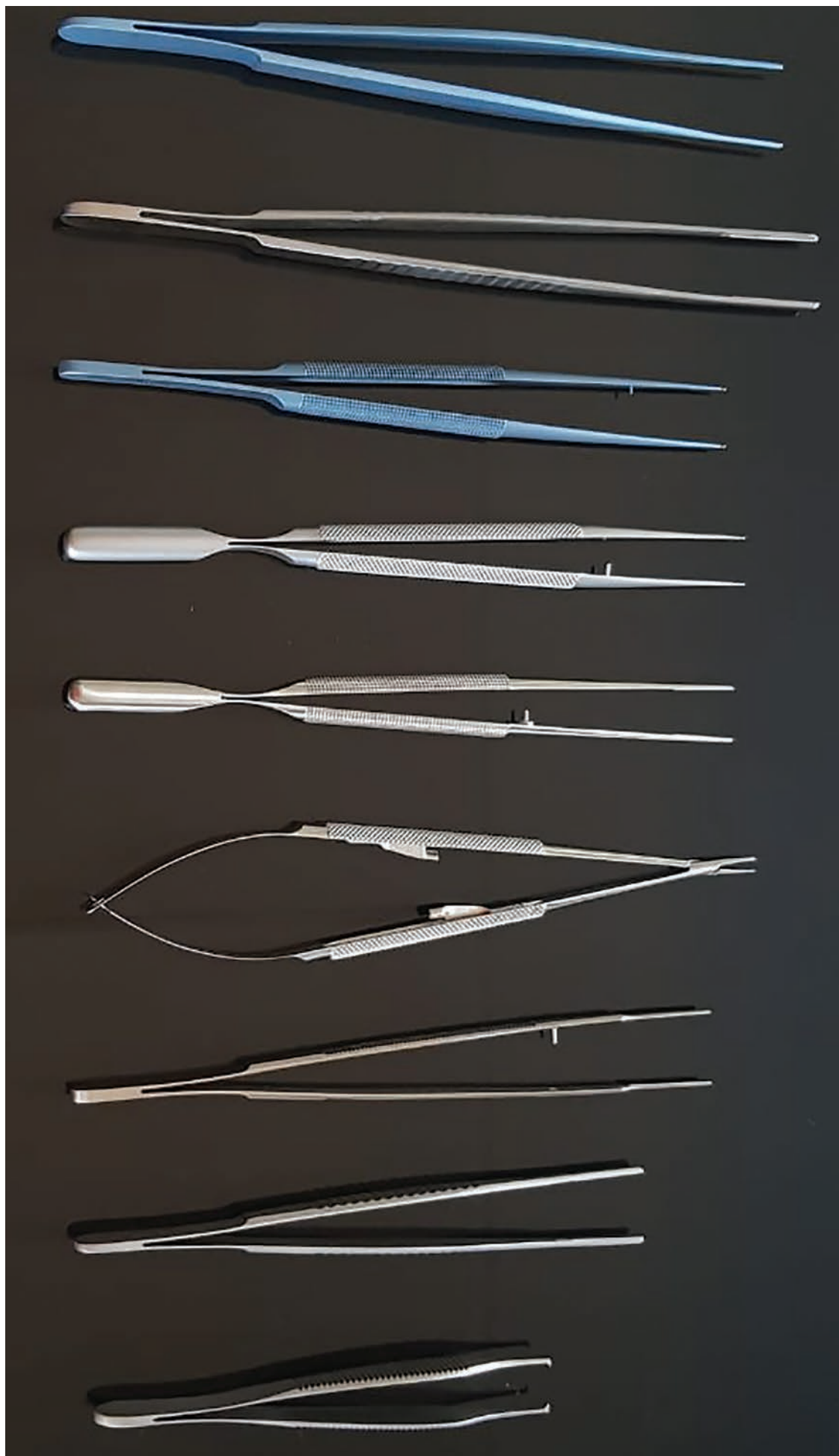

Index

Micro Needle Holder

Titanium Jacobson Micro Needle Holder Round Handle 0.8 mm Jaw	137
Titanium Jacobson Micro Needle Holder Round Handle 1 mm Jaw	138
Titanium Jacobson Micro Needle Holder Round Handle 1.2 mm Jaw 1.5 mm Jaw	139
Titanium Micro Needle Holder Flat Handle 0.8 mm Jaw	140
Titanium Micro Needle Holder Flat Handle 1 mm Jaw	141
Titanium Micro Needle Holder Flat Handle 1.2 mm Jaw	142
Titanium Micro Needle Holder Flat Handle 1.5 mm Jaw	143
Titanium Micro Needle Holder Diamond Dust Flat Handle 2 mm Jaw	144
Jacobson Micro Needle Holder Diamond Dust Round Handle 0.8 mm Jaw	145
Jacobson Micro Needle Holder Diamond Dust Round Handle 1 mm Jaw	146
Jacobson Micro Needle Holder Diamond Dust Round Handle 1.2 mm Jaw	147
Jacobson Micro Needle Holder Diamond Dust Round Handle 1.5 mm Jaw	148
Micro Needle Holder Diamond Dust Flat Handle 1 mm Jaw 1.2 mm Jaw	149
Micro Needle Holder Diamond Dust Flat Handle 1.5 mm Jaw 2 mm Jaw	150
Yasargil Micro Needle Holder Diamond Dust Flat Handle 0.8 mm Jaw 1.2 mm Jaw	151
Castroviejo Micro Needle Holder Flat Handle TC 0.8 mm Jaw	152
Castroviejo Micro Needle Holders Flat Handle TC 1 mm Jaw	153
Castroviejo Micro Needle Holder Flat Handle TC 1.2 mm Jaw	154
Castroviejo Micro Needle Holders Flat Handle TC 1.5 mm Jaw	155
Jacobson Micro Needle Holder Round Handle TC 1 mm Jaw	156
Jacobson Micro Needle Holder Round Handle TC 1.2 mm Jaw	157
Heavy Jacobson Round Handle Needle Holder TC 2 mm Jaw	158
Heavy Jacobson Round Handle Needle Holder Diamond Dusted 2 mm Jaw	159
Heavy Jacobson Round Handle Needle Holder Diamond Dusted 2.5 mm Jaw	159
Titanium Heavy Jacobson Round Handle Needle Holder Diamond Dusted 2 mm Jaw	160
Titanium Heavy Jacobson Round Handle Needle Holder Diamond Dusted 2.5 mm Jaw	160
Ryder-Vascular Needle Holder TC	161
Halsey Needle Holder TC	161
Micro-Vascular Needle Holder TC	162
DeBakey Needle Holder TC	163
Micro Ryder-Vascular Needle Holder TC	164
Mayo Hegar Needle Holder TC	165
Crile-Wood Needle Holder TC	166
Neivert Needle Holder TC	166
Baumgartner Wire Forceps	167
Wire Forceps TC Rounded	167
Wire Forceps TC Square Jaw	168
Wire Forceps Serrated Jaw	169
Wire Cutter TC	169-170

MICRO NEEDLE HOLDER

SKILL Micro Needle Holders are set for grasping needles without rotation. Enhanced Needle Grip Surface by placing a needle at the very tip and then slightly pushing or pulling it or by holding the closed tip up against the light.



Diamond Dust Inserts



0.8 mm Diamond Dusted Jaw
Suture 8-0 and smaller

1 mm Diamond Dusted Jaw
Suture 5-0 and smaller

1.2 mm Diamond Dusted Jaw
Suture 5-0 and smaller

1.5 mm Diamond Dusted Jaw
Suture 5-0 and smaller

2 mm Diamond Dusted Jaw
Suture 2-0 and smaller

Tungsten Carbide Inserts



0.8 mm w Inserts Jaw
Suture 8-0 and smaller

1 mm TC Inserts Jaw
Suture 5-0 and smaller

1.2 mm TC Inserts Jaw
Suture 5-0 and smaller

1.5 mm TC Inserts Jaw
Suture 5-0 and smaller

2 mm TC Inserts Jaw
Suture 4-0 and smaller

2.5 mm TC Inserts Jaw
Suture 4-0 and smaller

Titanium Jacobson Micro Needle Holder Round Handle 0.8 mm Jaw



0.8 mm Diamond Dusted Jaw
Suture 8-0 and smaller



Diamond
Dust Inserts

Description

Titanium Jacobson Micro Needle Holder Straight Jaw w/catch
 Titanium Jacobson Micro Needle Holder Curved Jaw w/catch
 Titanium Jacobson Micro Needle Holder Straight Jaw w/catch
 Titanium Jacobson Micro Needle Holder Curved Jaw w/catch
 Titanium Jacobson Micro Needle Holder Straight Jaw w/catch
 Titanium Jacobson Micro Needle Holder Curved Jaw w/catch
 Titanium Jacobson Micro Needle Holder Straight Jaw w/catch
 Titanium Jacobson Micro Needle Holder Curved Jaw w/catch

Length

18 cm
18 cm
21 cm
21 cm
23 cm
23 cm
25 cm
25 cm

Code

BI-1300-18T
BI-1301-18T
BI-1300-21T
BI-1301-21T
BI-1300-23T
BI-1301-23T
BI-1300-25T
BI-1301-25T



MICRO NEEDLE HOLDER

MICRO NEEDLE HOLDER

Titanium Jacobson Micro Needle Holder Round Handle 1 mm Jaw

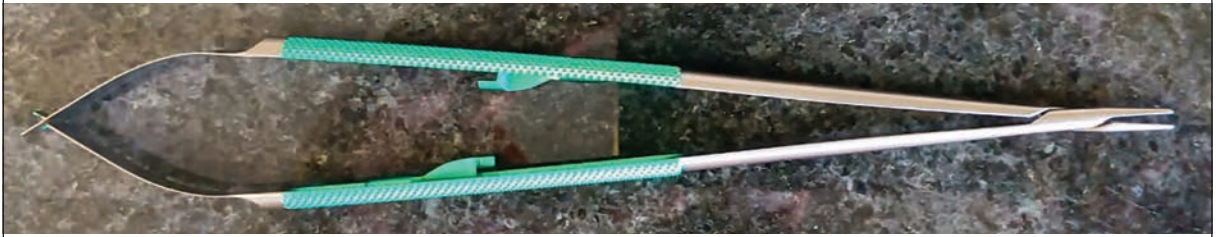

1 mm Diamond Dusted Jaw
Suture 5-0 and smaller



Diamond
Dust Inserts

Description	Length	Code
Titanium Jacobson MicWro Needle Holder Straight Jaw w/catch	18 cm	BI-1302-18T
Titanium Jacobson Micro Needle Holder Curved Jaw w/catch	18 cm	BI-1303-18T
Titanium Jacobson Micro Needle Holder Straight Jaw w/catch	21 cm	BI-1302-21T
Titanium Jacobson Micro Needle Holder Curved Jaw w/catch	21 cm	BI-1303-21T
Titanium Jacobson Micro Needle Holder Straight Jaw w/catch	23 cm	BI-1302-23T
Titanium Jacobson Micro Needle Holder Curved Jaw w/catch	23 cm	BI-1303-23T
Titanium Jacobson Micro Needle Holder Straight Jaw w/catch	25 cm	BI-1302-25T
Titanium Jacobson Micro Needle Holder Curved Jaw w/catch	25 cm	BI-1303-25T



Titanium Jacobson Micro Needle Holder Round Handle 1.2 mm Jaw

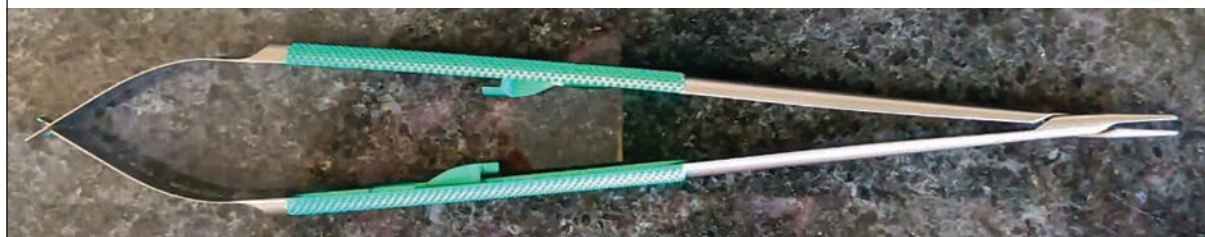

1.2 mm Diamond Dusted Jaw
Suture 5-0 and smaller



Diamond
Dust Inserts

Description	Length	Code
Titanium Jacobson Micro Needle Holder Straight Jaw w/catch	18 cm	BI-1305-18T
Titanium Jacobson Micro Needle Holder Curved Jaw w/catch	18 cm	BI-1304-18T
Titanium Jacobson Micro Needle Holder Straight Jaw w/catch	21 cm	BI-1305-21T
Titanium Jacobson Micro Needle Holder Curved Jaw w/catch	21 cm	BI-1304-21T
Titanium Jacobson Micro Needle Holder Straight Jaw w/catch	23 cm	BI-1305-23T
Titanium Jacobson Micro Needle Holder Curved Jaw w/catch	23 cm	BI-1304-23T
Titanium Jacobson Micro Needle Holder Straight Jaw w/catch	25 cm	BI-1305-25T
Titanium Jacobson Micro Needle Holder Curved Jaw w/catch	25 cm	BI-1304-25T

Titanium Jacobson Micro Needle Holder Round Handle 1.5 mm Jaw

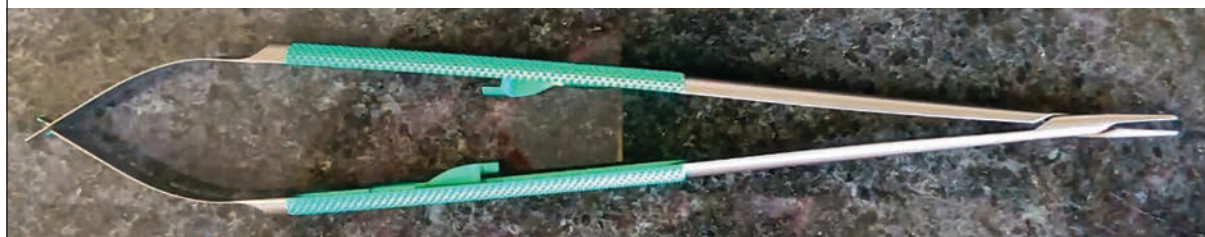

1.5 mm Diamond Dusted Jaw
Suture 5-0 and smaller



Diamond
Dust Inserts

Description	Length	Code
Titanium Jacobson Micro Needle Holder Straight Jaw w/catch	18 cm	BI-1306-18T
Titanium Jacobson Micro Needle Holder Curved Jaw w/catch	18 cm	BI-1307-18T
Titanium Jacobson Micro Needle Holder Straight Jaw w/catch	21 cm	BI-1306-21T
Titanium Jacobson Micro Needle Holder Curved Jaw w/catch	21 cm	BI-1307-21T
Titanium Jacobson Micro Needle Holder Straight Jaw w/catch	23 cm	BI-1306-23T
Titanium Jacobson Micro Needle Holder Curved Jaw w/catch	23 cm	BI-1307-23T
Titanium Jacobson Micro Needle Holder Straight Jaw w/catch	25 cm	BI-1306-25T
Titanium Jacobson Micro Needle Holder Curved Jaw w/catch	25 cm	BI-1307-25T

MICRO NEEDLE HOLDER

Titanium Micro Needle Holder Flat Handle 0.8 mm Jaw



0.8 mm Diamond Dusted Jaw
Suture 8-0 and smaller



Diamond
Dust Inserts

Description	Length	Code
Titanium Micro Needle Holder Straight Jaw w/catch	18 cm	BI-1309-18T
Titanium Micro Needle Holder Curved Jaw w/catch	18 cm	BI-1310-18T
Titanium Micro Needle Holder Straight Jaw w/catch	21 cm	BI-1309-21T
Titanium Micro Needle Holder Curved Jaw w/catch	21 cm	BI-1310-21T
Titanium Micro Needle Holder Straight Jaw w/catch	23 cm	BI-1309-23T
Titanium Micro Needle Holder Curved Jaw w/catch	23 cm	BI-1310-23T



Titanium Micro Needle Holder Flat Handle 1 mm Jaw



1 mm Diamond Dusted Jaw
Suture 5-0 and smaller



Diamond
Dust Inserts

Description	Length	Code
Titanium Micro Needle Holder Straight Jaw w/catch	18 cm	BI-1317-18T
Titanium Micro Needle Holder Curved Jaw w/catch	18 cm	BI-1318-18T
Titanium Micro Needle Holder Straight Jaw w/catch	21 cm	BI-1317-21T
Titanium Micro Needle Holder Curved Jaw w/catch	21 cm	BI-1318-21T
Titanium Micro Needle Holder Straight Jaw w/catch	23 cm	BI-1317-23T
Titanium Micro Needle Holder Curved Jaw w/catch	23 cm	BI-1318-23T



MICRO NEEDLE HOLDER

MICRO NEEDLE HOLDER

Titanium Micro Needle Holder Flat Handle 1.2 mm Jaw



1.2 mm Diamond Dusted Jaw
Suture 5-0 and smaller



Diamond
Dust Inserts

Description	Length	Code
Titanium Needle Holder Straight Jaw w/catch	18 cm	BI-1311-18T
Titanium Needle Holder Curved Jaw w/catch	18 cm	BI-1312-18T
Titanium Needle Holder Straight Jaw w/catch	21 cm	BI-1311-21T
Titanium Needle Holder Curved Jaw w/catch	21 cm	BI-1312-21T
Titanium Needle Holder Straight Jaw w/catch	23 cm	BI-1311-23T
Titanium Needle Holder Curved Jaw w/catch	23 cm	BI-1312-23T



Titanium Micro Needle Holder Flat Handle 1.5 mm Jaw



1.5 mm Diamond Dusted Jaw
Suture 5-0 and smaller



Diamond
Dust Inserts

Description

Titanium Needle Holder Straight Jaw w/catch
 Titanium Needle Holder Curved Jaw w/catch
 Titanium Needle Holder Straight Jaw w/catch
 Titanium Needle Holder Curved Jaw w/catch
 Titanium Needle Holder Straight Jaw w/catch
 Titanium Needle Holder Curved Jaw w/catch

Length

18 cm
 18 cm
 21 cm
 21 cm
 23 cm
 23 cm

Code

BI-1313-18T
 BI-1314-18T
 BI-1313-21T
 BI-1314-21T
 BI-1313-23T
 BI-1314-23T



MICRO NEEDLE HOLDER

MICRO NEEDLE HOLDER

Titanium Micro Needle Holder Diamond Dust Flat Handle 2 mm Jaw



2 mm Diamond Dusted Jaw
Suture 2-0 and smaller



Diamond
Dust Inserts

Description	Length	Code
Titanium Needle Holder Straight Jaw w/catch	18 cm	BI-1315-18T
Titanium Needle Holder Curved Jaw w/catch	18 cm	BI-1316-18T
Titanium Needle Holder Straight Jaw w/catch	23 cm	BI-1315-23T
Titanium Needle Holder Curved Jaw w/catch	23 cm	BI-1316-23T
Titanium Needle Holder Straight Jaw w/catch	25 cm	BI-1315-25T
Titanium Needle Holder Curved Jaw w/catch	25 cm	BI-1316-25T



Jacobson Micro Needle Holder Diamond Dust Round Handle 0.8 mm Jaw



0.8 mm Diamond Dusted Jaw
Suture 8-0 and smaller



Diamond
Dust Inserts

Description	Length	Code
Jacobson Micro Needle Holder Straight Jaw w/catch	16 cm	BI-1201-16
Jacobson Micro Needle Holder Curved Jaw w/catch	16 cm	BI-1202-16
Jacobson Micro Needle Holder Straight Jaw w/catch	18 cm	BI-1201-18
Jacobson Micro Needle Holder Curved Jaw w/catch	18 cm	BI-1202-18



MICRO NEEDLE HOLDER

Jacobson Micro Needle Holder Diamond Dust Round Handle 1 mm Jaw



1 mm Diamond Dusted Jaw
Suture 5-0 and smaller



Diamond
Dust Inserts

Description	Length	Code
Jacobson Micro Needle Holder Straight Jaw w/catch	18 cm	BI-1210-18
Jacobson Micro Needle Holder Curved Jaw w/catch	18 cm	BI-1211-18
Jacobson Micro Needle Holder Straight Jaw w/catch	21 cm	BI-1210-21
Jacobson Micro Needle Holder Curved Jaw w/catch	21 cm	BI-1211-21
Jacobson Micro Needle Holder Straight Jaw w/catch	23 cm	BI-1210-23
Jacobson Micro Needle Holder Curved Jaw w/catch	23 cm	BI-1211-23
Jacobson Micro Needle Holder Straight Jaw w/catch	25 cm	BI-1210-25
Jacobson Micro Needle Holder Curved Jaw w/catch	25 cm	BI-1211-25

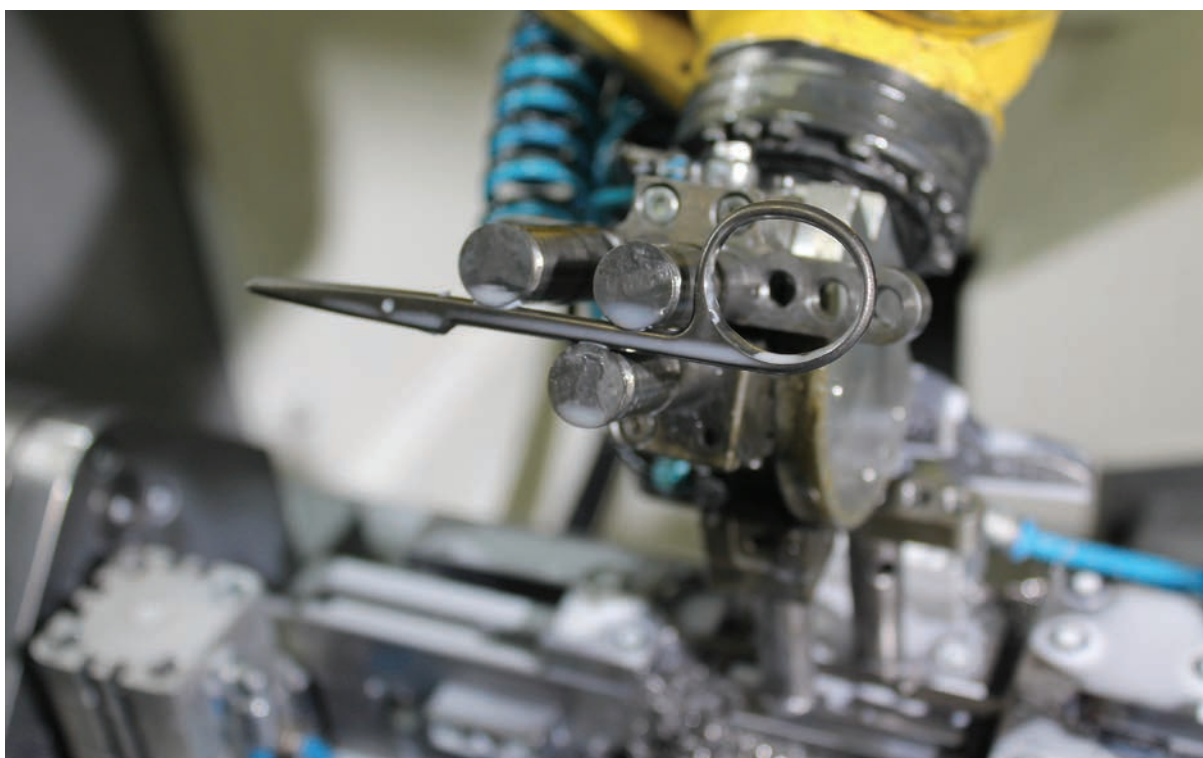

Jacobson Micro Needle Holder Diamond Dust Round Handle 1.2 mm Jaw



1.2 mm Diamond Dusted Jaw
Suture 5-0 and smaller



Diamond
Dust Inserts

Description

- Jacobson Micro Needle Holder Straight Jaw w/catch
- Jacobson Micro Needle Holder Curved Jaw w/catch
- Jacobson Micro Needle Holder Straight Jaw w/catch
- Jacobson Micro Needle Holder Curved Jaw w/catch
- Jacobson Micro Needle Holder Straight Jaw w/catch
- Jacobson Micro Needle Holder Curved Jaw w/catch
- Jacobson Micro Needle Holder Straight Jaw w/catch
- Jacobson Micro Needle Holder Curved Jaw w/catch

Length

- 18 cm
- 18 cm
- 21 cm
- 21 cm
- 23 cm
- 23 cm
- 25 cm
- 25 cm

Code

- BI-1212-18
- BI-1213-18
- BI-1212-21
- BI-1213-21
- BI-1212-23
- BI-1213-23
- BI-1212-25
- BI-1213-25



MICRO NEEDLE HOLDER

MICRO NEEDLE HOLDER

Jacobson Micro Needle Holder Diamond Dust Round Handle 1.5 mm Jaw



1.5 mm Diamond Dusted Jaw
Suture 5-0 and smaller



Diamond
Dust Inserts

Description	Length	Code
Jacobson Micro Needle Holder Straight Jaw w/catch	18 cm	BI-1208-18
Jacobson Micro Needle Holder Curved Jaw w/catch	18 cm	BI-1209-18
Jacobson Micro Needle Holder Straight Jaw w/catch	21 cm	BI-1208-21
Jacobson Micro Needle Holder Curved Jaw w/catch	21 cm	BI-1209-21
Jacobson Micro Needle Holder Straight Jaw w/catch	23 cm	BI-1208-23
Jacobson Micro Needle Holder Curved Jaw w/catch	23 cm	BI-1209-23
Jacobson Micro Needle Holder Straight Jaw w/catch	25 cm	BI-1208-25
Jacobson Micro Needle Holder Curved Jaw w/catch	25 cm	BI-1209-25



Micro Needle Holder Diamond Dust Flat Handle 1 mm Jaw



1 mm Diamond Dusted Jaw
Suture 5-0 and smaller



Diamond
Dust Inserts

Description	Length	Code
Micro Needle Holder Straight Jaw w/catch	18 cm	BI-1214-18
Micro Needle Holder Curved Jaw w/catch	18 cm	BI-1215-18
Micro Needle Holder Straight Jaw w/catch	23 cm	BI-1214-23
Micro Needle Holder Curved Jaw w/catch	23 cm	BI-1215-23
Micro Needle Holder Straight Jaw w/catch	25 cm	BI-1214-25
Micro Needle Holder Curved Jaw w/catch	25 cm	BI-1215-25

Micro Needle Holder Diamond Dust Flat Handle 1.2 mm Jaw



1.2 mm Diamond Dusted Jaw
Suture 5-0 and smaller



Diamond
Dust Inserts

Description	Length	Code
Micro Needle Holder Straight Jaw w/catch	18 cm	BI-1218-18
Micro Needle Holder Curved Jaw w/catch	18 cm	BI-1219-18
Micro Needle Holder Straight Jaw w/catch	21 cm	BI-1218-21
Micro Needle Holder Curved Jaw w/catch	21 cm	BI-1219-21
Micro Needle Holder Straight Jaw w/catch	23 cm	BI-1218-23
Micro Needle Holder Curved Jaw w/catch	23 cm	BI-1219-23

Micro Needle Holder Diamond Dust Flat Handle 1.5 mm Jaw



1.5 mm Diamond Dusted Jaw
Suture 5-0 and smaller



Diamond
Dust Inserts

Description	Length	Code
Micro Needle Holder Straight Jaw w/catch	18 cm	BI-1216-18
Micro Needle Holder Curved Jaw w/catch	18 cm	BI-1217-18
Micro Needle Holder Straight Jaw w/catch	23 cm	BI-1216-23
Micro Needle Holder Curved Jaw w/catch	23 cm	BI-1217-23
Micro Needle Holder Straight Jaw w/catch	25 cm	BI-1216-25
Micro Needle Holder Curved Jaw w/catch	25 cm	BI-1217-25

Micro Needle Holder Diamond Dust Flat Handle 2 mm Jaw



2 mm Diamond Dusted Jaw
Suture 2-0 and smaller



Diamond
Dust Inserts

Description	Length	Code
Micro Needle Holder Straight Jaw w/catch	28 cm	BI-1220-28
Micro Needle Holder Curved Jaw w/catch	28 cm	BI-1221-28
Micro Needle Holder Straight Jaw w/catch	30 cm	BI-1220-30
Micro Needle Holder Curved Jaw w/catch	30 cm	BI-1221-30
Micro Needle Holder Straight Jaw w/catch	32 cm	BI-1220-32
Micro Needle Holder Curved Jaw w/catch	32cm	BI-1221-32

Yasargil Micro Needle Holder Diamond Dust Flat Handle 0.8 mm Jaw



0.8 mm Diamond Dusted Jaw
Suture 8-0 and smaller



Diamond
Dust Inserts

Description

- Yasargil Needle Holder Straight Jaw w/catch
- Yasargil Needle Holder Curved Jaw w/catch
- Yasargil Needle Holder Straight Jaw w/catch
- Yasargil Needle Holder Curved Jaw w/catch
- Yasargil Needle Holder Straight Jaw w/catch
- Yasargil Needle Holder Curved Jaw w/catch

Length

- 18 cm
- 18 cm
- 21 cm
- 21 cm
- 23 cm
- 23 cm

Code

- BI-1222-18
- BI-1223-18
- BI-1222-21
- BI-1223-21
- BI-1222-23
- BI-1223-23

Yasargil Micro Needle Holder Diamond Dust Flat Handle 1.2 mm Jaw



1.2 mm Diamond Dusted Jaw
Suture 5-0 and smaller



Diamond
Dust Inserts

Description

- Yasargil Needle Holder Straight Jaw w/catch
- Yasargil Needle Holder Curved Jaw w/catch
- Yasargil Needle Holder Straight Jaw w/catch
- Yasargil Needle Holder Curved Jaw w/catch
- Yasargil Needle Holder Straight Jaw w/catch
- Yasargil Needle Holder Curved Jaw w/catch

Length

- 18 cm
- 18 cm
- 21 cm
- 21 cm
- 23 cm
- 23 cm

Code

- BI-1224-18
- BI-1225-18
- BI-1224-21
- BI-1225-21
- BI-1224-23
- BI-1225-23

MICRO NEEDLE HOLDER

Castroviejo Micro Needle Holder Flat Handle TC 0.8 mm Jaw



0.8 mm TC Inserts Jaw
Suture 8-0 and smaller



Tungsten
Carbide Inserts

Description	Length	Code
Castroviejo Micro Needle Holder Straight Flat Handle TC w/catch	18 cm	BI-1226-18
Castroviejo Micro Needle Holder Curved Flat Handle TC w/catch	18 cm	BI-1227-18
Castroviejo Micro Needle Holder Straight Flat Handle TC w/catch	21 cm	BI-1226-21
Castroviejo Micro Needle Holder Curved Flat Handle TC w/catch	21 cm	BI-1227-21
Castroviejo Micro Needle Holder Straight Flat Handle TC w/catch	23 cm	BI-1226-23
Castroviejo Micro Needle Holder Curved Flat Handle TC w/catch	23 cm	BI-1227-23

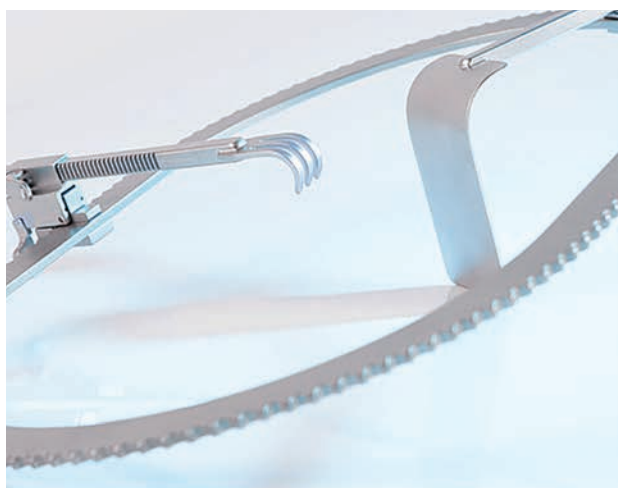

Castroviejo Micro Needle Holders Flat Handle TC 1 mm Jaw



1 mm TC Inserts Jaw
Suture 5-0 and smaller



Tungsten
Carbide Inserts

Description

Length

Code

Castroviejo Micro Needle Holder Straight Flat Handle TC w/catch	12 cm	BI-1336-12
Castroviejo Micro Needle Holder Curved Flat Handle TC w/catch	12 cm	BI-1338-12
Castroviejo Micro Needle Holder Straight Flat Handle TC w/catch	14 cm	BI-1336-14
Castroviejo Micro Needle Holder Curved Flat Handle TC w/catch	14 cm	BI-1338-14
Castroviejo Micro Needle Holder Straight Flat Handle TC w/catch	18 cm	BI-1336-18
Castroviejo Micro Needle Holder Curved Flat Handle TC w/catch	18 cm	BI-1338-18
Castroviejo Micro Needle Holder Straight Flat Handle TC w/catch	21 cm	BI-1336-21
Castroviejo Micro Needle Holder Curved Flat Handle TC w/catch	21 cm	BI-1338-21
Castroviejo Micro Needle Holder Straight Flat Handle TC w/catch	23 cm	BI-1336-23
Castroviejo Micro Needle Holder Curved Flat Handle TC w/catch	23 cm	BI-1338-23
Castroviejo Micro Needle Holder Straight Flat Handle TC w/catch	25 cm	BI-1336-25
Castroviejo Micro Needle Holder Curved Flat Handle TC w/catch	25 cm	BI-1338-25



MICRO NEEDLE HOLDER

MICRO NEEDLE HOLDER

Castroviejo Micro Needle Holder Flat Handle TC 1.2 mm Jaw



1.2 mm TC Inserts Jaw
Suture 5-0 and smaller



Tungsten
Carbide Inserts

Description	Length	Code
Castroviejo Micro Needle Holder Straight Flat Handle TC w/catch	18 cm	BI-1228-18
Castroviejo Micro Needle Holder Curved Flat Handle TC w/catch	18 cm	BI-1229-18
Castroviejo Micro Needle Holder Straight Flat Handle TC w/catch	21 cm	BI-1228-21
Castroviejo Micro Needle Holder Curved Flat Handle TC w/catch	21 cm	BI-1229-21
Castroviejo Micro Needle Holder Straight Flat Handle TC w/catch	23 cm	BI-1228-23
Castroviejo Micro Needle Holder Curved Flat Handle TC w/catch	23 cm	BI-1229-23



Castroviejo Micro Needle Holders Flat Handle TC 1.5 mm Jaw



1.5 mm TC Inserts Jaw
Suture 5-0 and smaller



Tungsten
Carbide Inserts

Description	Length	Code
Castroviejo Micro Needle Holder Straight Flat Handle TC w/catch	12 cm	BI-1337-12
Castroviejo Micro Needle Holder Curved Flat Handle TC w/catch	12 cm	BI-1339-12
Castroviejo Micro Needle Holder Straight Flat Handle TC w/catch	14 cm	BI-1337-14
Castroviejo Micro Needle Holder Curved Flat Handle TC w/catch	14 cm	BI-1339-14
Castroviejo Micro Needle Holder Straight Flat Handle TC w/catch	18 cm	BI-1337-18
Castroviejo Micro Needle Holder Curved Flat Handle TC w/catch	18 cm	BI-1339-18
Castroviejo Micro Needle Holder Straight Flat Handle TC w/catch	21 cm	BI-1337-21
Castroviejo Micro Needle Holder Curved Flat Handle TC w/catch	21 cm	BI-1339-21
Castroviejo Micro Needle Holder Straight Flat Handle TC w/catch	23 cm	BI-1337-23
Castroviejo Micro Needle Holder Curved Flat Handle TC w/catch	23 cm	BI-1339-23
Castroviejo Micro Needle Holder Straight Flat Handle TC w/catch	25 cm	BI-1337-25
Castroviejo Micro Needle Holder Curved Flat Handle TC w/catch	25 cm	BI-1339-25



MICRO NEEDLE HOLDER

MICRO NEEDLE HOLDER

Jacobson Micro Needle Holder Round Handle TC 1 mm Jaw



1 mm TC Inserts Jaw
Suture 5-0 and smaller



Tungsten
Carbide Inserts

Description	Length	Code
Jacobson Micro Needle Holder Straight Round Handle TC w/catch	14 cm	BI-1331-14
Jacobson Micro Needle Holder Curved Round Handle TC w/catch	14 cm	BI-1333-14
Jacobson Micro Needle Holder Straight Round Handle TC w/catch	18 cm	BI-1331-18
Jacobson Micro Needle Holder Curved Round Handle TC w/catch	18 cm	BI-1333-18
Jacobson Micro Needle Holder Straight Round Handle TC w/catch	21 cm	BI-1331-21
Jacobson Micro Needle Holder Curved Round Handle TC w/catch	21 cm	BI-1333-21
Jacobson Micro Needle Holder Straight Round Handle TC w/catch	23 cm	BI-1331-23
Jacobson Micro Needle Holder Curved Round Handle TC w/catch	23 cm	BI-1333-23
Jacobson Micro Needle Holder Straight Round Handle TC w/catch	25 cm	BI-1331-25
Jacobson Micro Needle Holder Curved Round Handle TC w/catch	25 cm	BI-1333-25
Jacobson Micro Needle Holder Straight Round Handle TC w/catch	28 cm	BI-1331-28
Jacobson Micro Needle Holder Curved Round Handle TC w/catch	28 cm	BI-1333-28



Jacobson Micro Needle Holder Round Handle TC 1.2 mm Jaw



1.2 mm TC Inserts Jaw
Suture 5-0 and smaller



Tungsten
Carbide Inserts

Description

- Jacobson Micro Needle Holder Straight Round Handle TC w/catch 14 cm
- Jacobson Micro Needle Holder Curved Round Handle TC w/catch 14 cm
- Jacobson Micro Needle Holder Straight Round Handle TC w/catch 18 cm
- Jacobson Micro Needle Holder Curved Round Handle TC w/catch 18 cm
- Jacobson Micro Needle Holder Straight Round Handle TC w/catch 21 cm
- Jacobson Micro Needle Holder Curved Round Handle TC w/catch 21 cm
- Jacobson Micro Needle Holder Straight Round Handle TC w/catch 23 cm
- Jacobson Micro Needle Holder Curved Round Handle TC w/catch 23 cm
- Jacobson Micro Needle Holder Straight Round Handle TC w/catch 25 cm
- Jacobson Micro Needle Holder Curved Round Handle TC w/catch 25 cm
- Jacobson Micro Needle Holder Straight Round Handle TC w/catch 28 cm
- Jacobson Micro Needle Holder Curved Round Handle TC w/catch 28 cm

Length

Code

- BI-1332-14
- BI-1334-14
- BI-1332-18
- BI-1334-18
- BI-1332-21
- BI-1334-21
- BI-1332-23
- BI-1334-23
- BI-1332-25
- BI-1334-25
- BI-1332-28
- BI-1334-28

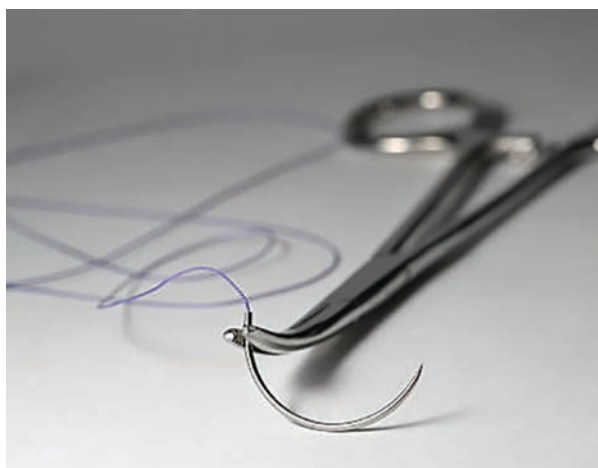

MICRO NEEDLE HOLDER

Heavy Jacobson Round Handle Needle Holder TC 2 mm Jaw

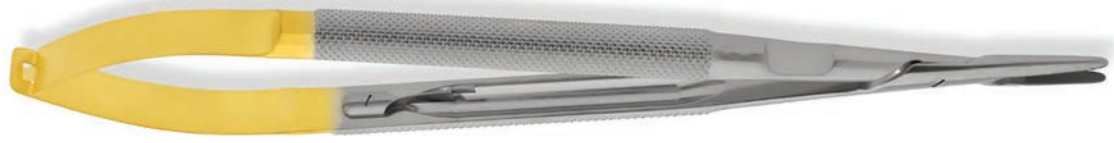

2 mm TC Inserts Jaw
Suture 4-0 and smaller



Tungsten
Carbide Inserts

Description	Length	Code
Jacobson Micro Needle Holder Straight Round Handle TC w/catch	18 cm	BI-1340-18
Jacobson Micro Needle Holder Curved Round Handle TC w/catch	18 cm	BI-1342-18
Jacobson Micro Needle Holder Straight Round Handle TC w/catch	21 cm	BI-1340-21
Jacobson Micro Needle Holder Curved Round Handle TC w/catch	21 cm	BI-1342-21
Jacobson Micro Needle Holder Straight Round Handle TC w/catch	23 cm	BI-1340-23
Jacobson Micro Needle Holder Curved Round Handle TC w/catch	23 cm	BI-1342-23

Heavy Jacobson Round Handle Needle Holder TC 2.5 mm Jaw

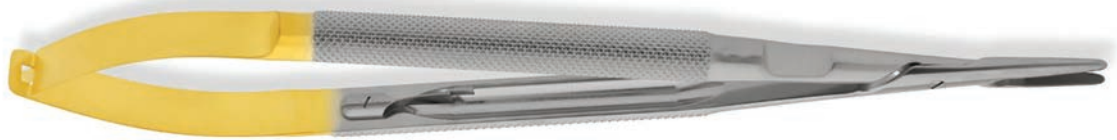

2.5 mm Jaw Diamond Dusted
for sutures 2-0 and smaller



Tungsten
Carbide Inserts

Description	Length	Code
Jacobson Micro Needle Holder Straight Round Handle TC w/catch	18 cm	BI-1341-18
Jacobson Micro Needle Holder Straight Round Handle TC w/catch	21 cm	BI-1341-21
Jacobson Micro Needle Holder Straight Round Handle TC w/catch	23 cm	BI-1341-23
Jacobson Micro Needle Holder Curved Round Handle TC w/catch	18 cm	BI-1343-18
Jacobson Micro Needle Holder Curved Round Handle TC w/catch	21 cm	BI-1343-21
Jacobson Micro Needle Holder Curved Round Handle TC w/catch	23 cm	BI-1343-23

Heavy Jacobson Round Handle Needle Holder Diamond Dusted 2 mm Jaw



2 mm Jaw Diamond Dusted
for sutures 2-0 and smaller



Diamond
Dust Inserts

Description

- Jacobson Micro Needle Holder Straight Round Handle w/catch
- Jacobson Micro Needle Holder Curved Round Handle w/catch
- Jacobson Micro Needle Holder Straight Round Handle w/catch
- Jacobson Micro Needle Holder Curved Round Handle w/catch
- Jacobson Micro Needle Holder Straight Round Handle w/catch
- Jacobson Micro Needle Holder Curved Round Handle w/catch

Length

- 19 cm
- 19 cm
- 23 cm
- 23 cm
- 25 cm
- 25 cm

Code

- BI-1344-19
- BI-1345-19
- BI-1344-23
- BI-1345-23
- BI-1344-25
- BI-1345-25

Heavy Jacobson Round Handle Needle Holder Diamond Dusted 2.5 mm Jaw



2.5 mm Jaw Diamond Dusted
for sutures 2-0 and smaller



Diamond
Dust Inserts

Description

- Jacobson Micro Needle Holder Straight Round Handle w/catch
- Jacobson Micro Needle Holder Curved Round Handle w/catch
- Jacobson Micro Needle Holder Straight Round Handle w/catch
- Jacobson Micro Needle Holder Curved Round Handle w/catch
- Jacobson Micro Needle Holder Straight Round Handle w/catch
- Jacobson Micro Needle Holder Curved Round Handle w/catch

Length

- 19 cm
- 19 cm
- 23 cm
- 23 cm
- 25 cm
- 25 cm

Code

- BI-1346-19
- BI-1347-19
- BI-1346-23
- BI-1347-23
- BI-1346-25
- BI-1347-25

**Titanium Heavy Jacobson Round Handle Needle Holder
Diamond Dusted 2 mm Jaw**



2 mm Diamond Dusted Jaw
Suture 2-0 and smaller



Diamond
Dust Inserts



Description	Length	Code
Titanium Jacobson Micro Needle Holder Straight Round Handle w/catch	19 cm	BI-1344-19T
Titanium Jacobson Micro Needle Holder Curved Round Handle w/catch	19 cm	BI-1345-19T
Titanium Jacobson Micro Needle Holder Straight Round Handle w/catch	23 cm	BI-1344-23T
Titanium Jacobson Micro Needle Holder Curved Round Handle w/catch	23 cm	BI-1345-23T
Titanium Jacobson Micro Needle Holder Straight Round Handle w/catch	25 cm	BI-1344-25T
Titanium Jacobson Micro Needle Holder Curved Round Handle w/catch	25 cm	BI-1345-25T

**Titanium Heavy Jacobson Round Handle Needle Holder
Diamond Dusted 2.5 mm Jaw**



2 mm Diamond Dusted Jaw
Suture 2-0 and smaller



Diamond
Dust Inserts



Description	Length	Code
Titanium Jacobson Micro Needle Holder Straight Round Handle w/catch	19 cm	BI-1346-19T
Titanium Jacobson Micro Needle Holder Curved Round Handle w/catch	19 cm	BI-1347-19T
Titanium Jacobson Micro Needle Holder Straight Round Handle w/catch	23 cm	BI-1346-23T
Titanium Jacobson Micro Needle Holder Curved Round Handle w/catch	23 cm	BI-1347-23T
Titanium Jacobson Micro Needle Holder Straight Round Handle w/catch	25 cm	BI-1346-25T
Titanium Jacobson Micro Needle Holder Curved Round Handle w/catch	25 cm	BI-1347-25T

Ryder-Vascular Needle Holder TC



Description

- Ryder-Vascular Needle Holder TC
- Ryder-Vascular Needle Holder TC
- Ryder-Vascular Needle Holder TC
- Ryder-Vascular Needle Holder TC
- Ryder-Vascular Needle Holder TC
- Ryder-Vascular Needle Holder TC

Length

- 13 cm
- 15 cm
- 18 cm
- 20 cm
- 23 cm
- 26 cm

Code

- BI-110-13
- BI-110-15
- BI-110-18
- BI-110-20
- BI-110-23
- BI-110-26

Halsey Needle Holder TC

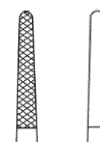

Description

- Halsey Needle Holder TC Serrated Jaw
- Halsey Needle Holder TC Smooth Jaw

Length

- 13 cm
- 13 cm

Code

- BI-026-13
- BI-028-13

MICRO NEEDLE HOLDER

Micro-Vascular Needle Holder TC



Description

Micro-Vascular Needle Holder TC
 Micro-Vascular Needle Holder TC
 Micro-Vascular Needle Holder TC
 Micro-Vascular Needle Holder TC

Length

14 cm
 18 cm
 20 cm
 23 cm

Code

BI-109-14
 BI-109-18
 BI-109-20
 BI-109-23

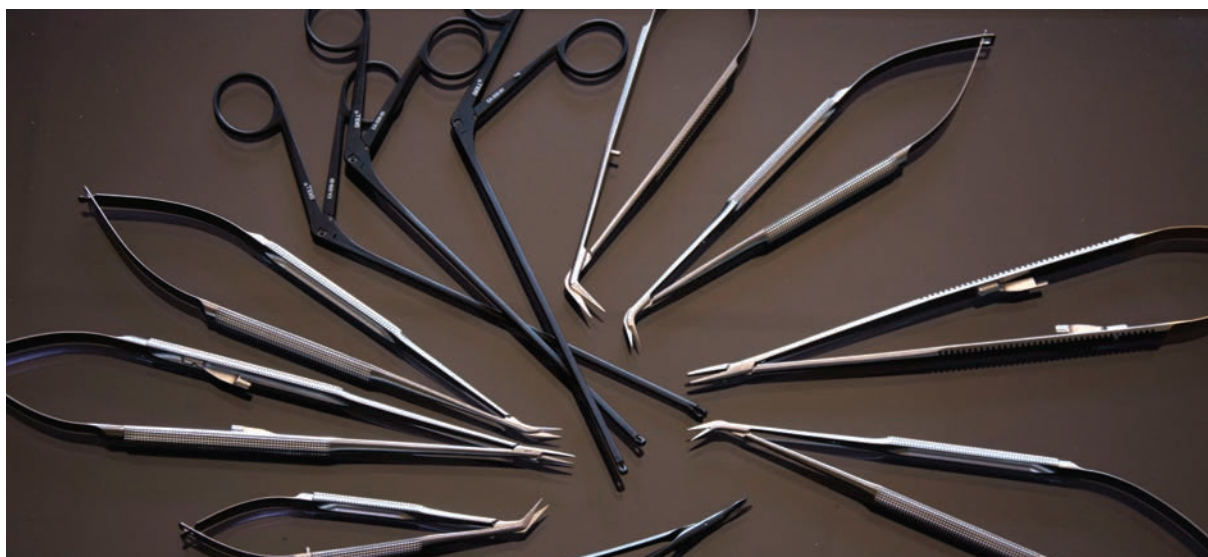

DeBakey Needle Holder TC

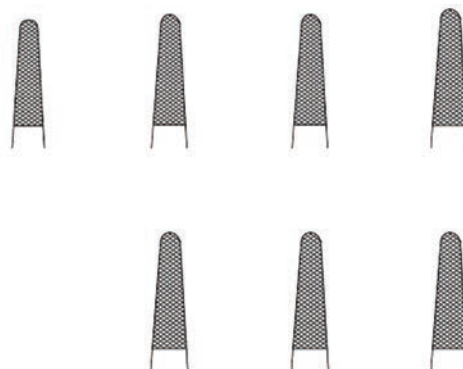

Description

- DeBakey Needle Holder TC
- DeBakey Needle Holder TC
- DeBakey Needle Holder TC
- DeBakey Needle Holder TC
- DeBakey Needle Holder TC
- DeBakey Needle Holder TC
- DeBakey Needle Holder TC
- DeBakey Needle Holder TC

Length

- 15 cm
- 16 cm
- 18 cm
- 20 cm
- 23 cm
- 26 cm
- 31 cm
- 37 cm

Code

- BI-004-15
- BI-004-16
- BI-004-18
- BI-004-20
- BI-004-23
- BI-004-26
- BI-004-31
- BI-004-37



MICRO NEEDLE HOLDER

MICRO NEEDLE HOLDER

Micro Ryder-Vascular Needle Holder TC

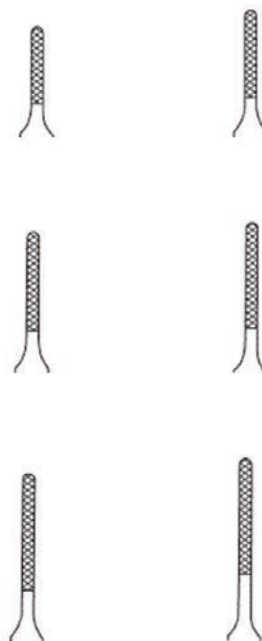

Description

- Micro Ryder-Vascular Needle Holder TC
- Micro Ryder-Vascular Needle Holder TC
- Micro Ryder-Vascular Needle Holder TC
- Micro Ryder-Vascular Needle Holder TC
- Micro Ryder-Vascular Needle Holder TC
- Micro Ryder-Vascular Needle Holder TC

Length

- 13 cm
- 15 cm
- 18 cm
- 20 cm
- 23 cm
- 26 cm

Code

- BI-112-13
- BI-112-15
- BI-112-18
- BI-112-20
- BI-112-23
- BI-112-26



Mayo Hegar Needle Holder TC

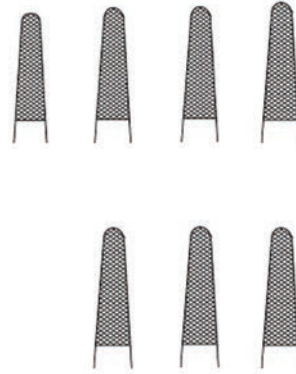

Description

- Mayo Hegar Needle Holder TC
- Mayo Hegar Needle Holder TC
- Mayo Hegar Needle Holder TC
- Mayo Hegar Needle Holder TC
- Mayo Hegar Needle Holder TC
- Mayo Hegar Needle Holder TC
- Mayo Hegar Needle Holder TC
- Mayo Hegar Needle Holder TC
- Mayo Hegar Needle Holder TC
- Mayo Hegar Needle Holder TC

Length

- 14 cm
- 16 cm
- 18 cm
- 20 cm
- 24 cm
- 26 cm
- 30 cm
- 36 cm
- 40 cm

Code

- BI-512-14
- BI-512-16
- BI-512-18
- BI-512-20
- BI-512-24
- BI-512-26
- BI-512-30
- BI-512-36
- BI-512-40



MICRO NEEDLE HOLDER

MICRO NEEDLE HOLDER

Crile-Wood Needle Holder TC

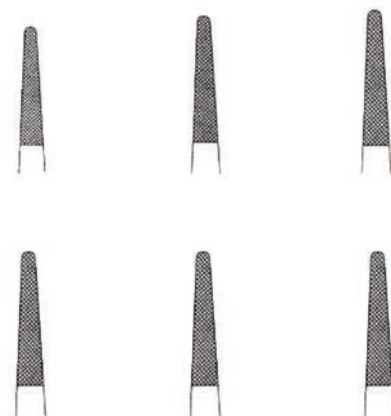

Description

- Crile-Wood Needle Holder TC
- Crile-Wood Needle Holder TC
- Crile-Wood Needle Holder TC
- Crile-Wood Needle Holder TC
- Crile-Wood Needle Holder TC
- Crile-Wood Needle Holder TC

Length

- 15 cm
- 18 cm
- 20 cm
- 23 cm
- 26 cm
- 31 cm

Code

- BI-001-15
- BI-001-18
- BI-001-20
- BI-001-23
- BI-001-26
- BI-001-31

Neivert Needle Holder TC



Description

- Neivert Needle Holder TC

Length

- 13 cm

Code

- BI-024-13

Baumgartner Wire Forceps



Description	Total Length	Code
Baumgartner Wire Forceps TC	20 cm	EB-1911-20

Wire Forceps TC Rounded



Description	Total Length	Code
Wire Forceps TC Rounded Jaw	15 cm	EB-1925-15
Wire Forceps TC Rounded Jaw	18 cm	EB-1925-18
Wire Forceps TC Rounded Jaw	20 cm	EB-1925-20



Wire Forceps TC Square Jaw

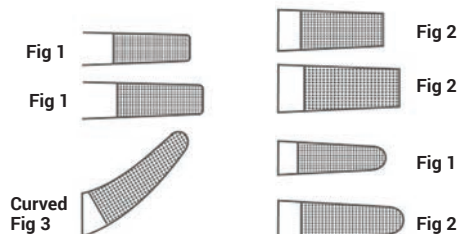

Description	Total Length	Code
Wire Forceps TC Square Jaw	15 cm	EB-1913-15
Wire Forceps TC Square Jaw	18 cm	EB-1913-18
Wire Forceps TC Square Jaw	20 cm	EB-1913-20
Wire Forceps TC Fine Round Jaw	15 cm	EB-1924-15
Wire Forceps TC Fine Round Jaw	18 cm	EB-1925-18
Wire Forceps TC Fine Square Jaw	15 cm	EB-1927-15
Wire Forceps TC Fine Square Jaw	18 cm	EB-1927-18
Wire Forceps TC Round Curved Jaw	18 cm	EB-1928-18

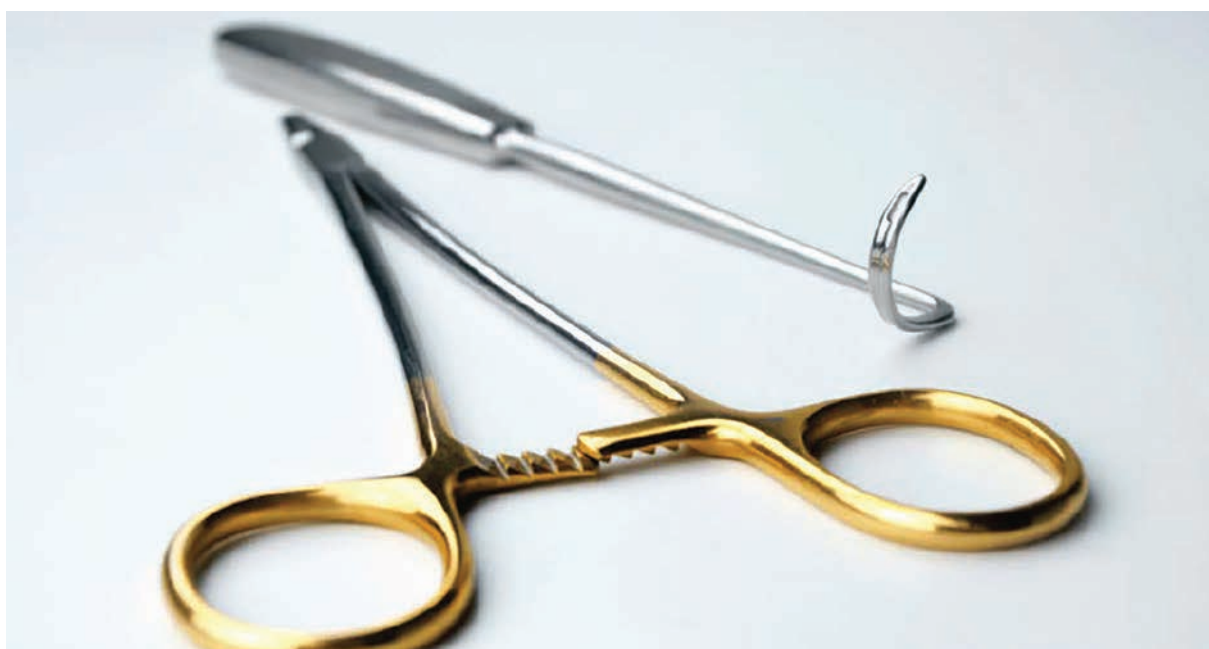

Wire Forceps Serrated Jaw



Description	Total Length	Code
Wire Forceps Serrated Jaw	15 cm	EB-1930-15
Wire Forceps Serrated jaw	18 cm	EB-1930-18
Wire Forceps Serrated Jaw	20 cm	EB-1930-20
Wire Forceps Serrated Jaw	22 cm	EB-1930-22

Wire Cutter TC



Description	Total Length	Code
Wire Cutter TC	16 cm	EB-1873-16

Wire Cutter TC



For soft wires
up to Ø 2.0 mm
For hard wires
up to Ø 1.7 mm



For soft wires
up to Ø 2.8 mm
For hard wires
up to Ø 2.2 mm

Description

Wire Cutter TC

Wire Cutter TC

Total Length

18 cm

22 cm

Code

EB-1873-18

EB-1873-22



SKILL[®]
Surgical Instruments

**MICRO
VASCULAR CLAMPS**





Index

Micro Vascular Clamps

Cooley Paediatric Vascular Clamp	174-196
Cooley Vascular Clamp	196
Cooley Vena Cava Vascular Clamp	197
Castaneda Neonatal Vascular Clamp	198-201
Castaneda Paediatric Clamp	202-203
Titanium Micro Kitzmiller Neonatal Vascular Clamp	204
DeBakey Vascular Clamp	204-230
Favaloro Vascular Clamp Lambert-Kay Vascular Clamp	231
Parsonnet Vascular Clamp	232
Strong Aorta Vascular Clamp	233
Fogerty Insert Clamp	234
Leland-Jones Vascular Clamp	235
Wylie Clamp	235-239
Liver Clamp	239
Pean Artery Forceps Straight Curved	240-241
Spencer-Wells Artery Forceps Straight	242
Heiss Artery Forceps Adson Artery Forceps	243
Crile Artery Forceps Kelly Artery Forceps	244
Birkett Artery Forceps Halsted-Mosquito Artery Forceps	245
Micro-Mosquito Artery Forceps	246
Kocher Artery Forceps Straight	247
Kocher Artery Forceps Curved	248
Gemini Artery Forceps Curved Crafoord Artery Forceps Curved	249
Roberts Artery Forceps Bailey Fine Forceps	250
Mixer Artery Forceps Curved	251-252
Lahey Artery Forceps	252
Rampleny Sponge Holding Forceps Duval Grasping Forceps	253
Duval DeBakey Grasping Forceps Babcock Grasping Forceps	254
Allis Grasping Forceps Littlewood Grasping Forceps	255
Backhaus Towel Forceps Ball & Socket Towel Forceps	256
Lane Towel Forceps Lorna Towel Forceps	257
Tubing Clamp Forceps Straight Tubing Clamp With Guard Forceps Straight	258
O'Shaughnessy Artery Forceps Gregory Suture Tag Forceps	259

Cooley Ultralight Paediatric Vascular Clamp Jaw 1.5 mm

Description	Length	Code
Cooley Ultralight Vascular Clamp Handles Straight	13 cm	CC-6300-13
Cooley Ultralight Vascular Clamp Handles Angled	13 cm	CC-6302-13

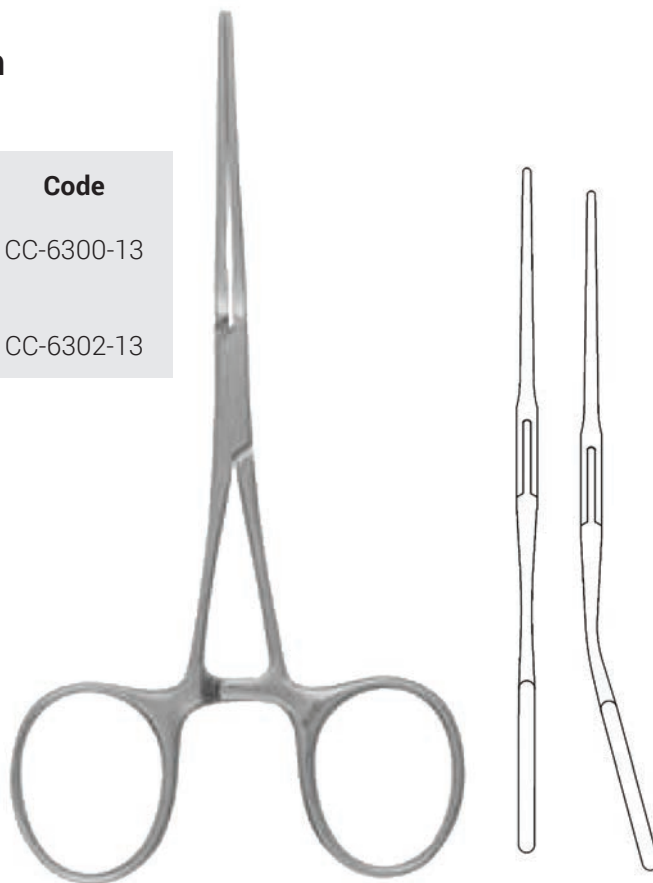

Cooley Ultralight Paediatric Vascular Clamp Jaw 1.5 mm

Description	Length	Code
Cooley Ultralight Vascular Clamp Handles Straight Jaw Slightly Curved	13 cm	CC-6303-13



Cooley Ultralight Paediatric Vascular Clamp Jaw 1.5 mm

Description

Cooley Ultralight Vascular
Clamp Handles Straight
Jaw Curved

Length

12 cm

Code

CC-6306-12



Cooley Ultralight Paediatric Vascular Clamp Jaw 1.5 mm

Description

Cooley Ultralight Vascular
Clamp Handles Curved
Jaw Slightly Curved

Length

13 cm

Code

CC-6307-13

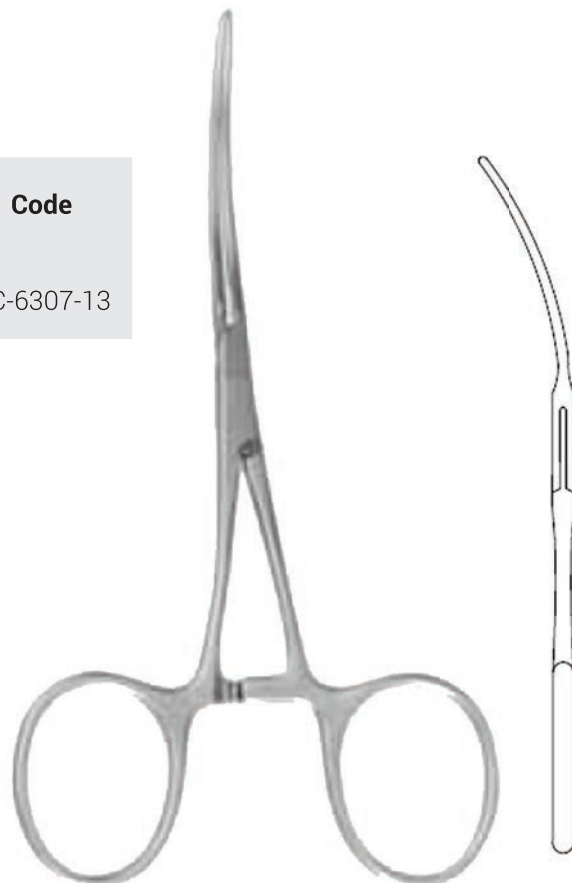

Cooley Selman Ultralight Paediatric Vascular Clamp

Description	Length	Code
Cooley Selman Ultralight Vascular Clamp Handles/Jaw Straight	13 cm	CC-6150-13
Cooley Selman Ultralight Vascular Clamp Handles/Jaw Straight	14 cm	CC-6152-14

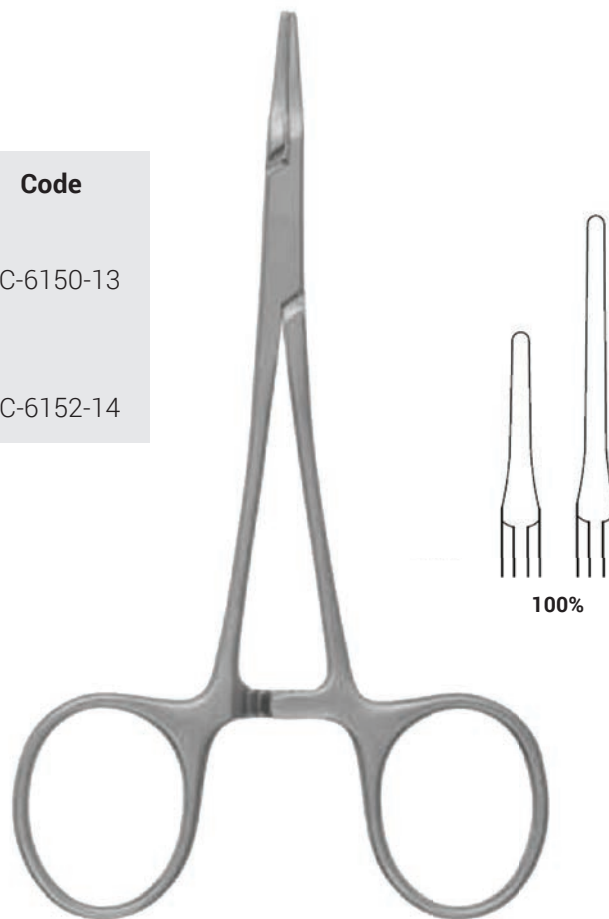

Cooley Selman Ultralight Paediatric Vascular Clamp

Description	Length	Code
Cooley Selman Ultralight Vascular Clamp Handles Straight Jaw 50°	12 cm	CC-6151-12
Cooley Selman Ultralight Vascular Clamp Handles Straight Jaw 30°	14 cm	CC-6153-14

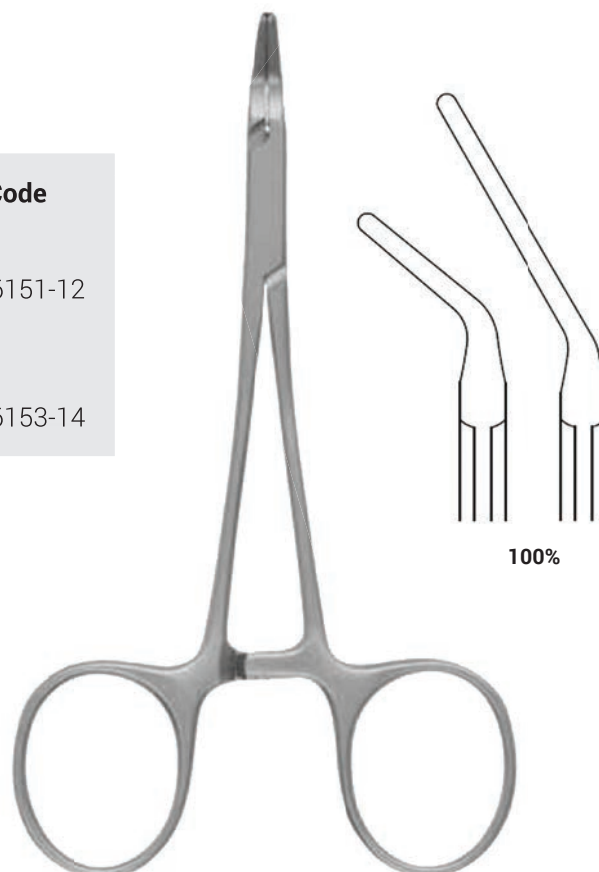

**Cooley Selman Ultralight
Paediatric Vascular Clamp**

Description	Length	Code
Cooley Selman Ultralight Vascular Clamp Handles Straight Jaw Fully Curved	12 cm	CC-6170-12

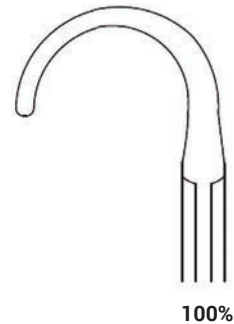

**Cooley Selman Ultralight
Paediatric Vascular Clamp**

Description	Length	Code
Cooley Selman Vascular Clamp Handles Straight Jaw 90° 20 mm Jaw	12 cm	CC-6355-12
Cooley Selman Vascular Clamp Handles Straight Jaw 90° 30 mm Jaw	12 cm	CC-6356-12
Cooley Selman Vascular Clamp Handles Straight Jaw 90° 40 mm Jaw	12 cm	CC-6357-12

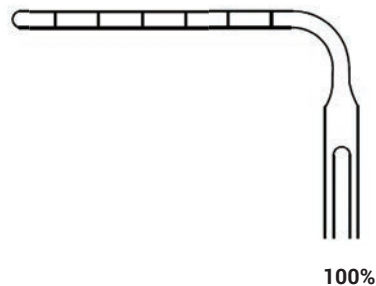
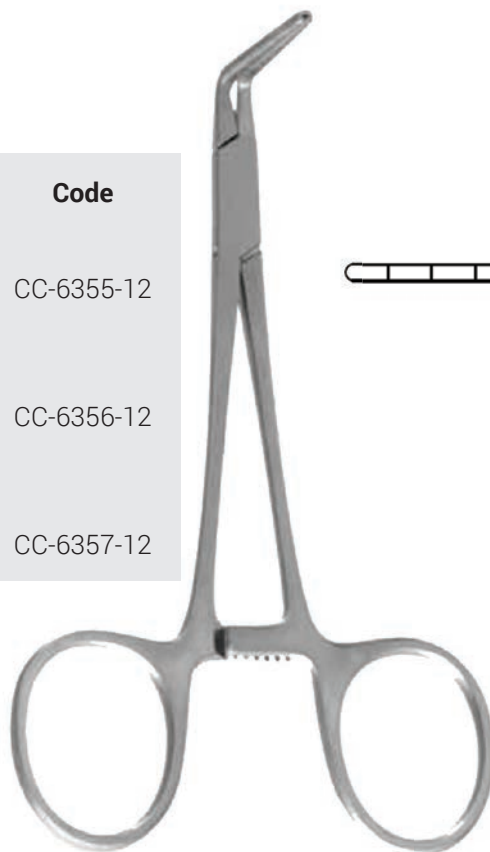

MICRO VASCULAR CLAMPS

Cooley Paediatric Vascular Clamp

Description	Length	Code
Cooley Paediatric Vascular Clamp Handles Straight Jaw 30°	14 cm	CC-6351-14

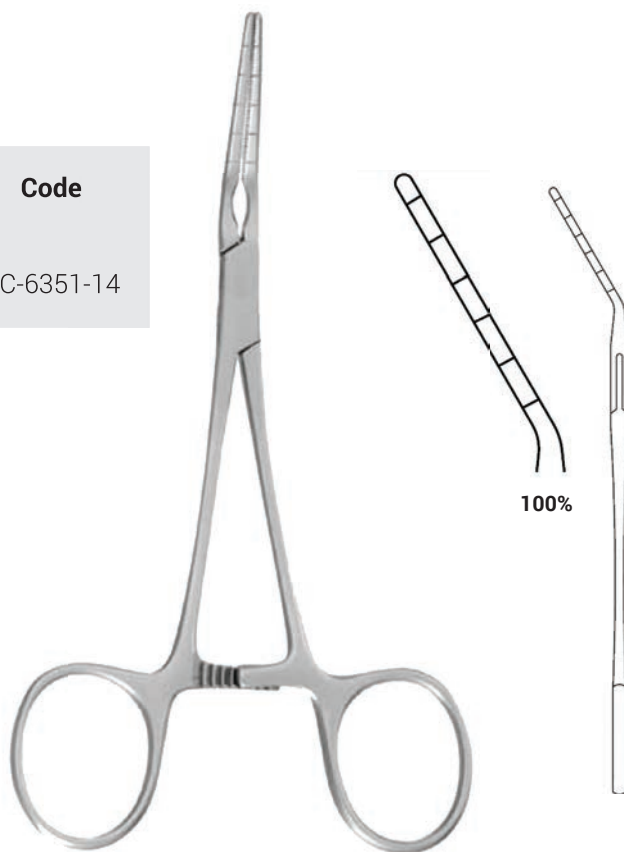

Cooley Paediatric Vascular Clamp

Description	Length	Code
Cooley Paediatric Vascular Clamp Handles Curved Jaw Straight	14 cm	CC-6352-14

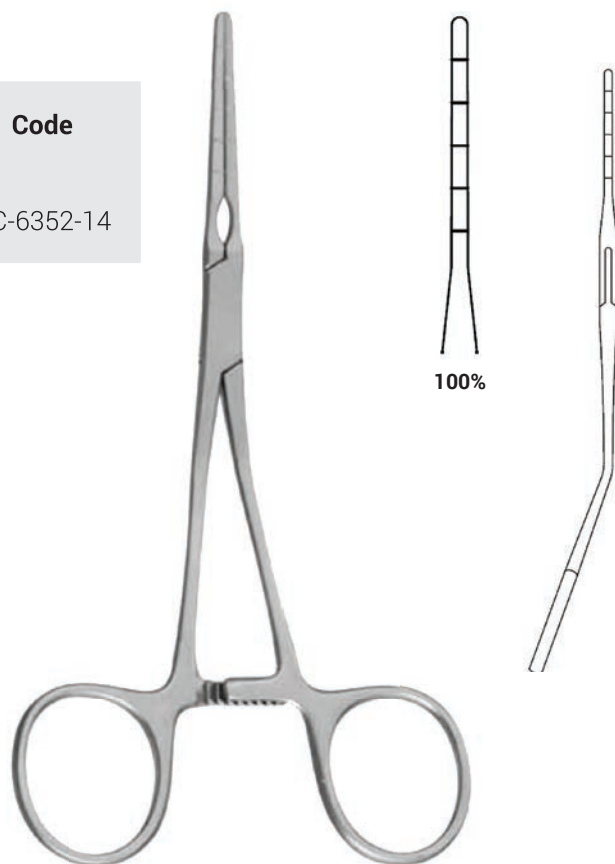

Cooley Paediatric Vascular Clamp

Description

Cooley Paediatric Vascular Clamp
Handles/Jaw Straight

Length

14 cm

Code

CC-6350-14

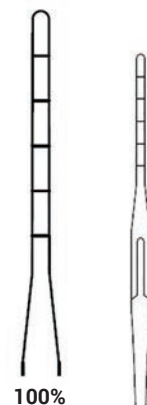

Cooley Paediatric Vascular Clamp

Description

Cooley Paediatric Vascular Clamp Handles
Curved Jaw Satinsky

Length

14 cm

Code

CC-6354-14

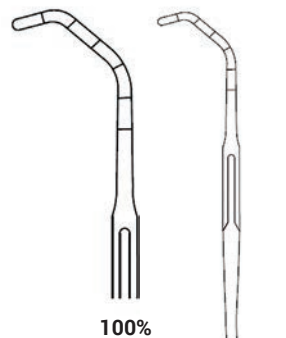

MICRO VASCULAR CLAMPS

MICRO VASCULAR CLAMPS

Cooley Paediatric Vascular Clamp

Description	Length	Code
Cooley Paediatric Vascular Clamp Handles Straight Jaw Spoon Shaped	14 cm	CC-6353-14



Cooley Paediatric Vascular Clamp

Cooley Delicate Paediatric Clamps 14 cm

Jaw Type	Handle A Straight	Handle B Curved	Handle C Angled
1	CC-6571-14	CC-6371-14	CC-6581-14
2	CC-6572-14	CC-6372-14	CC-6582-14
3	CC-6573-14	CC-6373-14	CC-6583-14
4	CC-6574-14	CC-6374-14	CC-6584-14
5	CC-6575-14	CC-6375-14	CC-6585-14
6	CC-6576-14	CC-6376-14	CC-6586-14
7	CC-6577-14	CC-6377-14	CC-6587-14
8	CC-6578-14	CC-6378-14	CC-6588-14
9	CC-6570-14	CC-6370-14	CC-6580-14

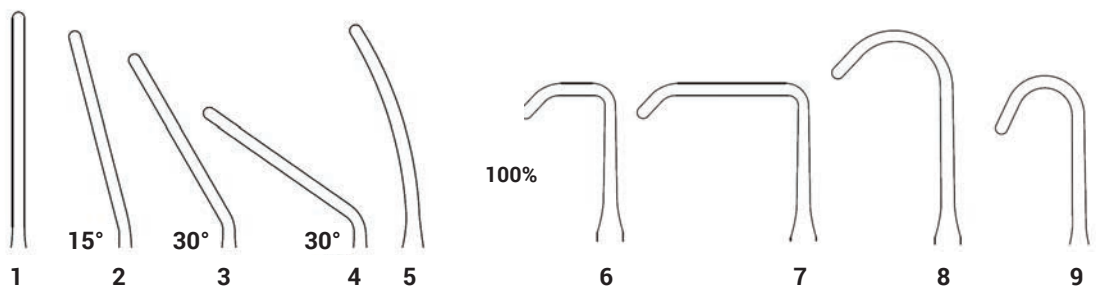
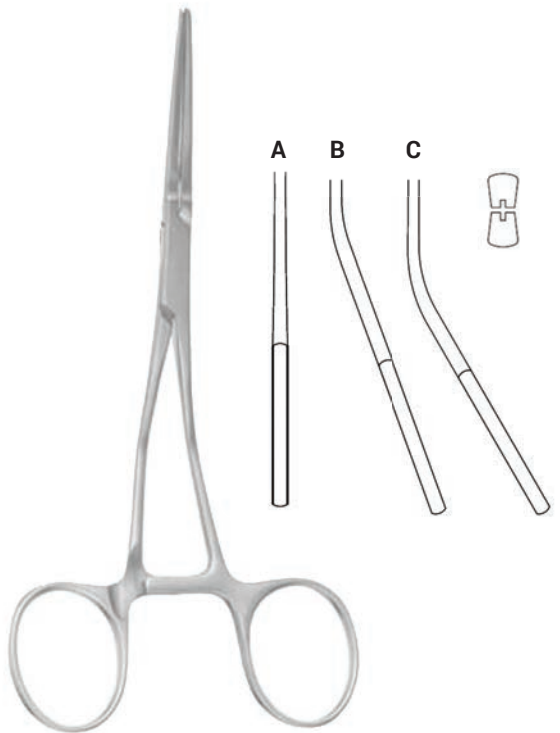

**Cooley Kitzmiller
Paediatric Vascular Clamp**

Description	Length	Code
Cooley Kitzmiller Vascular Clamp Handles Straight Jaw Curved Left	13 cm	CC-6622-13
Cooley Kitzmiller Vascular Clamp Handles Straight Jaw Curved Right	13 cm	CC-6620-13

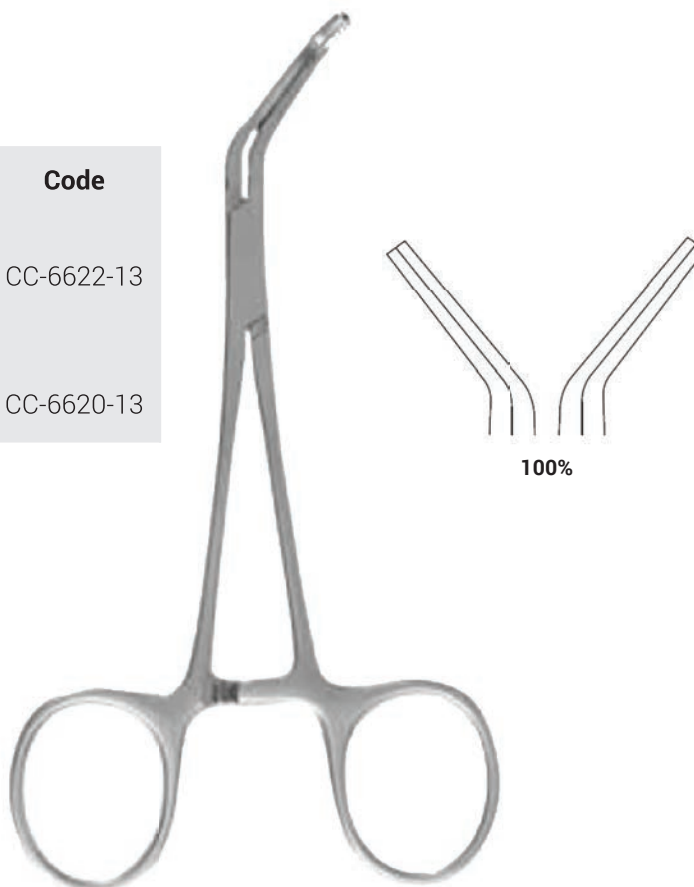

**Cooley Martinez
Paediatric Vascular Clamp**

Description	Length	Code
Cooley Martinez Vascular Clamp Handles Straight Jaw Curved Left	18 cm	CC-6612-18
Cooley Martinez Vascular Clamp Handles Straight Jaw Curved Right	18 cm	CC-6610-18



Cooley Paediatric Vascular Clamp

Description	Length	Code
Cooley Vascular Clamp Handles/Jaw Straight	17 cm	CC-5022-17



100%

Cooley Paediatric Vascular Clamp

Description	Length	Code
Cooley Vascular Clamp Handles Straight Jaw Curved	16 cm	CC-5031-16

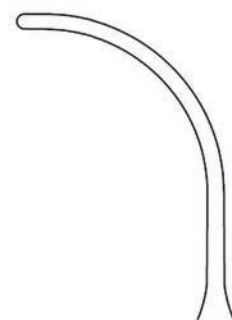

100%

Cooley Paediatric Vascular Clamp

Description	Length	Code
Cooley Vascular Clamp Handles Curved Jaw 45°	18 cm	CC-5026-18

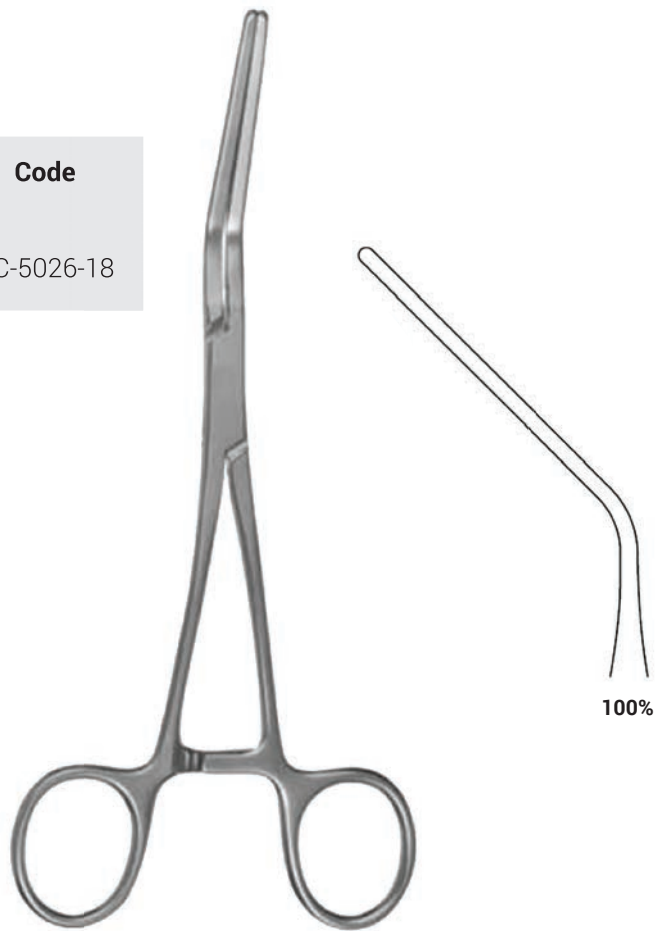

Cooley Paediatric Vascular Clamp

Description	Length	Code
Cooley Vascular Clamp Handles Curved Jaw 60° Jaw 30 mm	16 cm	CC-5023-16
Cooley Vascular Clamp Handles Curved Jaw 60° Jaw 40 mm	16 cm	CC-5024-16
Cooley Vascular Clamp Handles Curved Jaw 60° Jaw 50 mm	17 cm	CC-5025-17

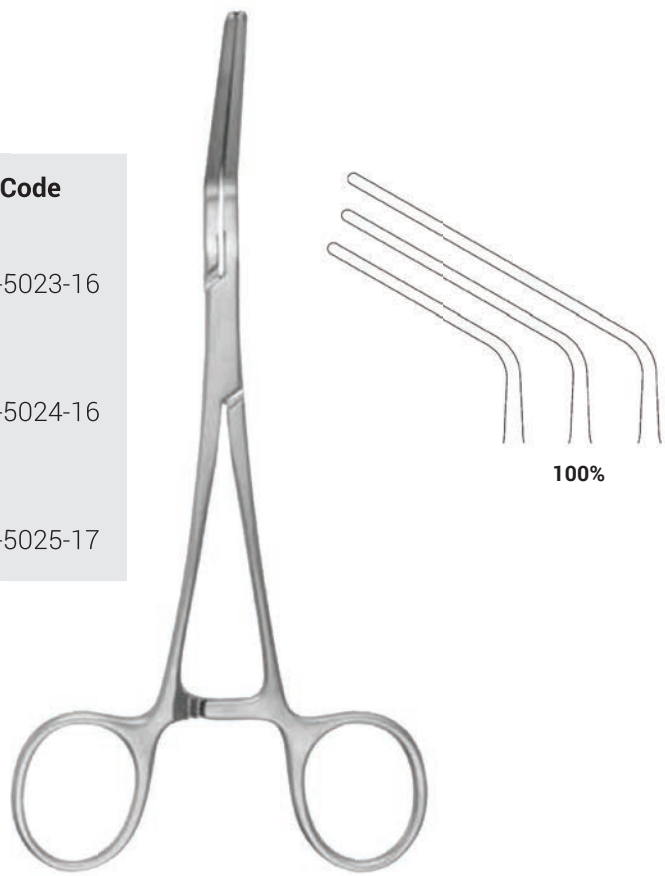

MICRO VASCULAR CLAMPS

Cooley Paediatric Vascular Clamp

Description	Length	Code
Cooley Vascular Clamp Handles Straight Jaw Satinsky	14 cm	CC-6520-14

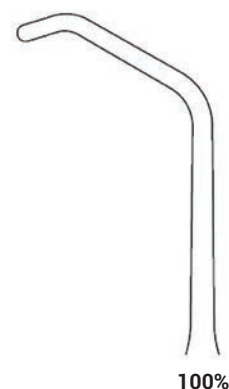

100%

Cooley Paediatric Vascular Clamp

Description	Length	Code
Cooley Vascular Clamp Handles/Jaw Straight	16 cm	CC-3800-16
Cooley Vascular Clamp Handles Curved Jaw Straight	16 cm	CC-3801-16



100%

Cooley Paediatric Vascular Clamp

Description	Length	Code
Cooley Vascular Clamp Handles/Jaw Straight	17 cm	CC-3802-17
Cooley Vascular Clamp Handles Curved Jaw Straight	17 cm	CC-3803-17

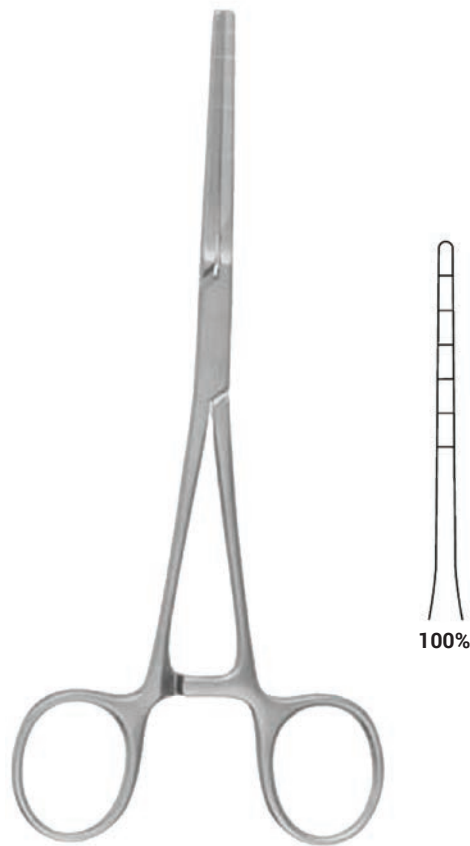

Cooley Paediatric Vascular Clamp

Description	Length	Code
Cooley Vascular Clamp Handles Straight Jaw Slightly Curved	17 cm	CC-3804-17

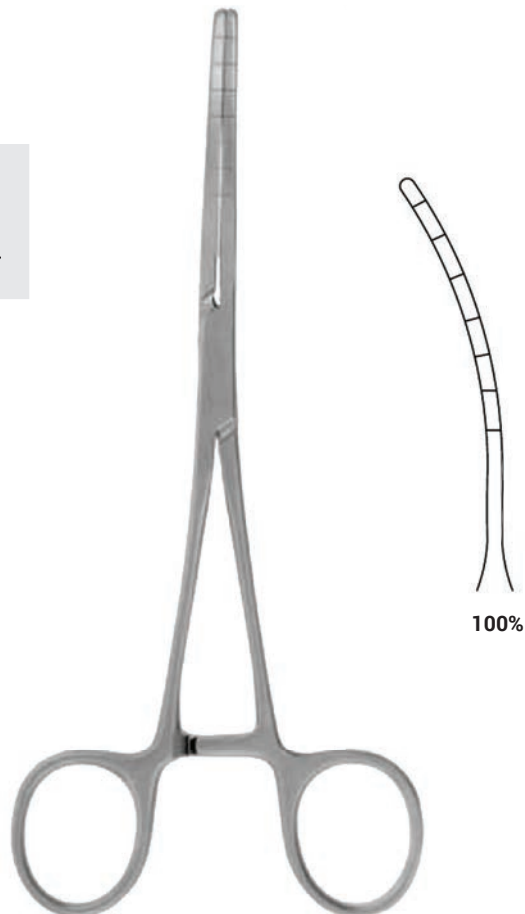

MICRO VASCULAR CLAMPS

Cooley Paediatric Vascular Clamp

Description	Length	Code
Cooley Vascular Clamp Handles Straight Jaw Fully Curved Jaw 28 mm	15 cm	CC-3810-15
Cooley Vascular Clamp Handles Straight Jaw Fully Curved Jaw 35 mm	16 cm	CC-3812-16

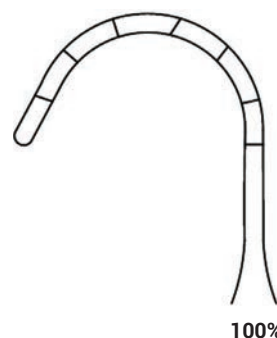

Cooley Paediatric Vascular Clamp

Description	Length	Code
Cooley Vascular Clamp Handles Curved Jaw Fully Curved	17 cm	CC-3826-17
Cooley Vascular Clamp Handles Curved Jaw Fully Curved	16 cm	CC-3827-16

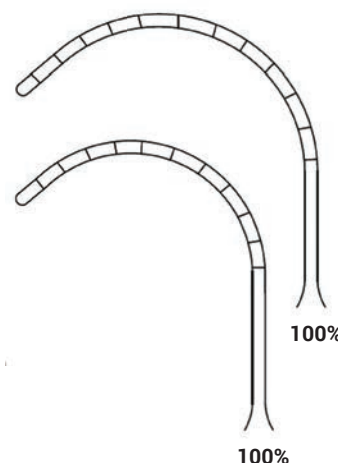

Cooley Paediatric Vascular Clamp

Description	Length	Code
Cooley Vascular Clamp Handles Straight Jaw Spoonshaped	18 cm	CC-3808-18

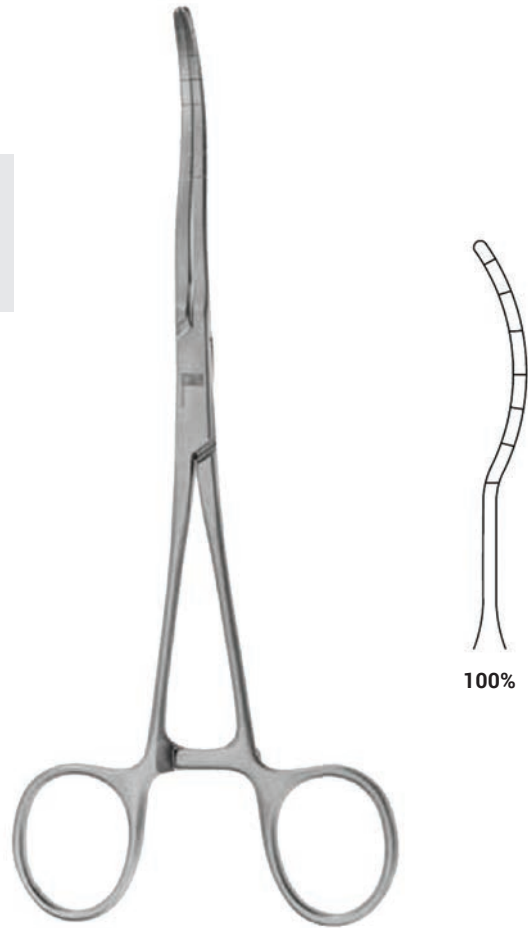

Cooley Paediatric Vascular Clamp

Description	Length	Code
Cooley Vascular Clamp Handles Curved Jaw Angled 30°	16 cm	CC-3805-16
Cooley Vascular Clamp Handles Curved Jaw Angled 60°	16 cm	CC-3806-16
Cooley Vascular Clamp Handles Curved Jaw Angled 90°	16 cm	CC-3807-16

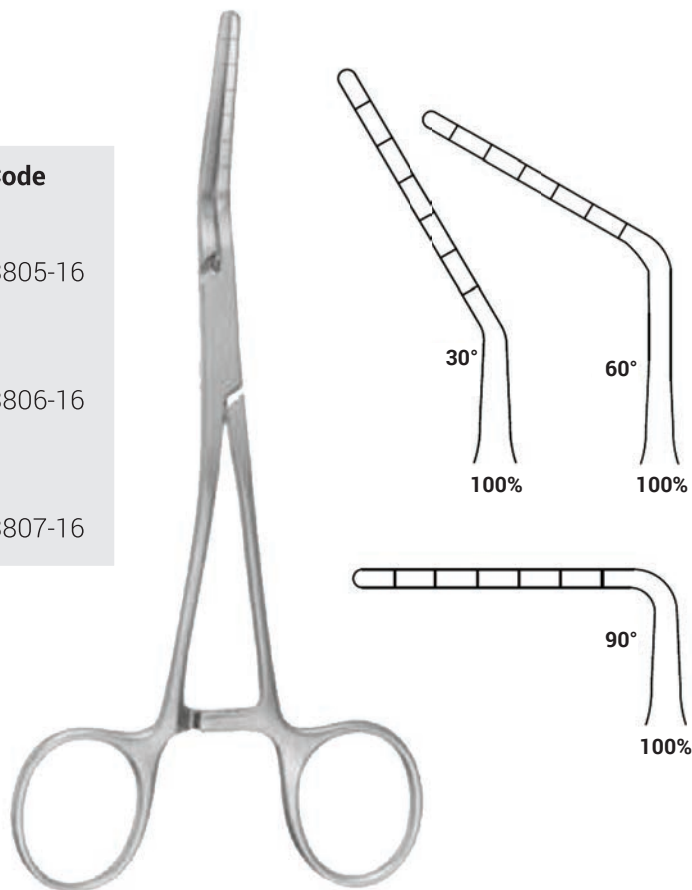

MICRO VASCULAR CLAMPS

Cooley Derra Paediatric Vascular Clamp

Description	Length	Code
Cooley Derra Vascular Clamp Handles Curved Jaw Satinsky	17 cm	CC-3815-17
Cooley Derra Vascular Clamp Handles Curved Jaw Satinsky	17 cm	CC-3816-17
Cooley Derra Vascular Clamp Handles Curved Jaw Satinsky	17 cm	CC-3817-17

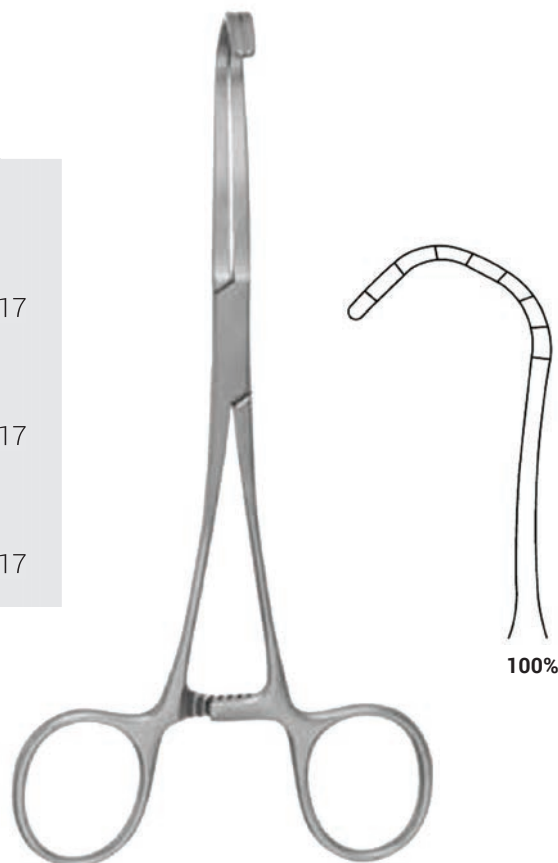

Cooley Paediatric Vascular Clamp

Description	Length	Code
Cooley Vascular Clamp Handles Curved Jaw Satinsky 90°	18 cm	CC-3830-18
Cooley Vascular Clamp Handles Curved Jaw Satinsky 90°	18 cm	CC-3831-18

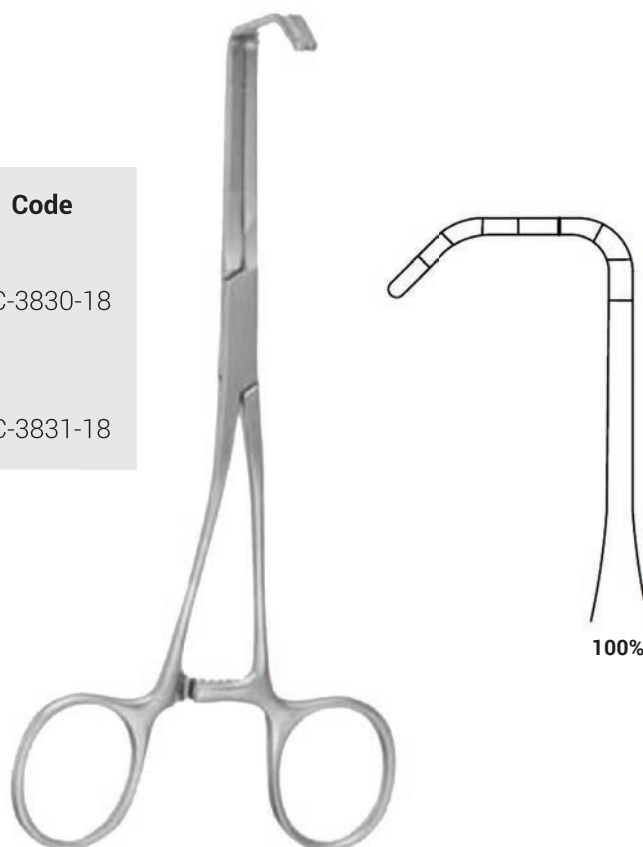

Cooley Paediatric Vascular Clamp

Description	Length	Code
Cooley Vascular Clamp Handles Curved Jaw Satinsky Jaw 20 mm	16 cm	CC-3125-16



Cooley Paediatric Vascular Clamp

Description	Length	Code
Cooley Vascular Clamp Handles Curved Jaw Satinsky Jaw 20 mm	16 cm	CC-3845-16

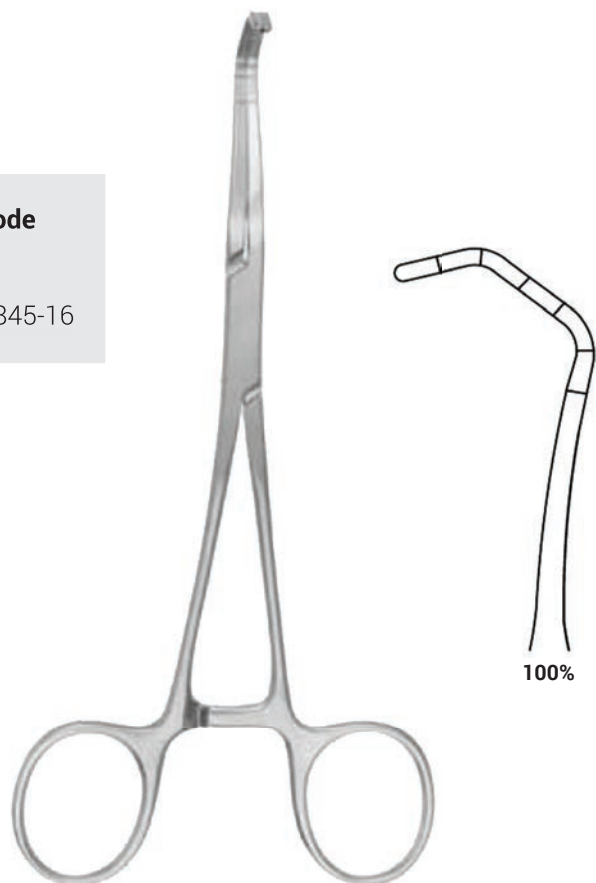

MICRO VASCULAR CLAMPS

MICRO VASCULAR CLAMPS

Cooley Satinsky Vascular Clamp

Description	Length	Code
Cooley Satinsky Vascular Clamp Handles Angled Jaw Satinsky Jaw 20 mm	20 cm	CC-3870-20
Cooley Satinsky Vascular Clamp Handles Angled Jaw Satinsky Jaw 30 mm	20 cm	CC-3872-20
Cooley Satinsky Vascular Clamp Handles Angled Jaw Satinsky Jaw 40 mm	20 cm	CC-3874-20

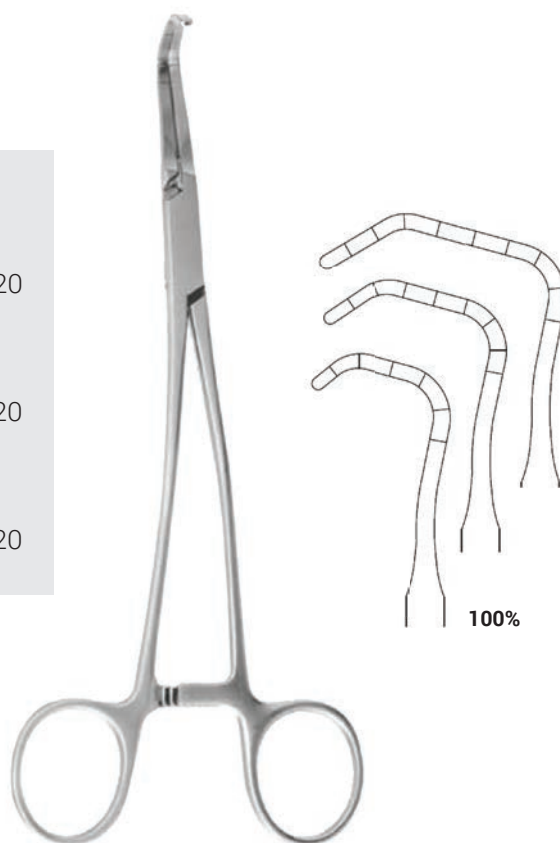

Cooley Vascular Clamp

Description	Length	Code
Cooley Vascular Clamp Handles/Jaw Straight Jaw 56 mm	22 cm	CC-5040-22
Cooley Vascular Clamp Handles Angled Jaw Straight Jaw 56 mm	21 cm	CC-5041-21

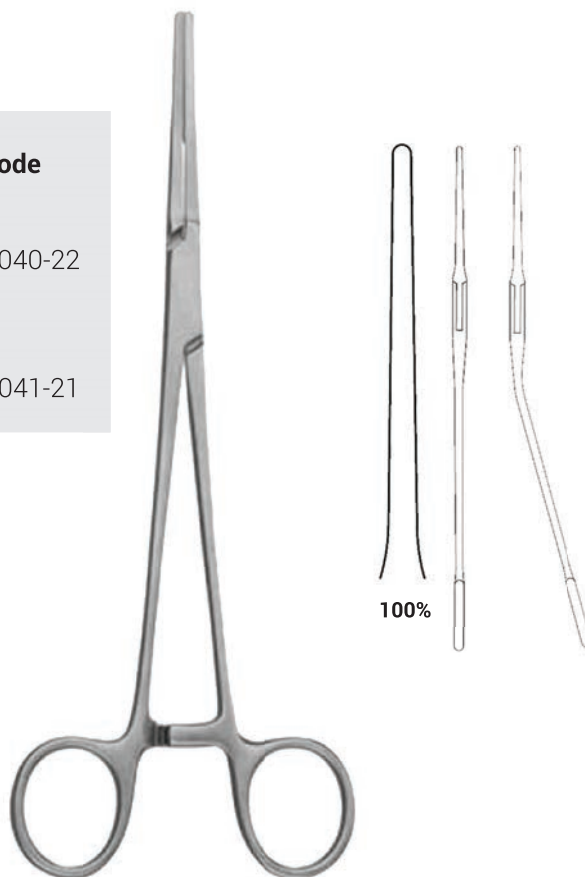

Cooley Vascular Clamp

Description	Length	Code
Cooley Vascular Clamp Handles/Jaw Straight Jaw 70 mm	24 cm	CC-5043-24
Cooley Vascular Clamp Handles Angled Jaw Straight Jaw 70 mm	24 cm	CC-5044-24
Cooley Vascular Clamp Handles/Jaw Straight Jaw 50 mm	22 cm	CC-5045-22
Cooley Vascular Clamp Handles Angled Jaw Straight Jaw 50 mm	22 cm	CC-5046-22

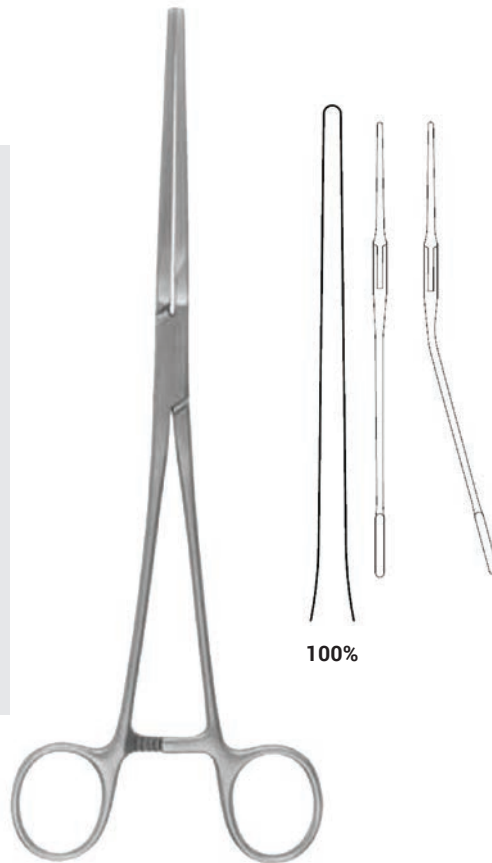

Cooley Vascular Clamp

Description	Length	Code
Cooley Vascular Clamp Handles Angled Jaw Straight Jaw 70 mm	20 cm	CC-3850-20
Cooley Vascular Clamp Handles Angled Jaw Straight Jaw 70 mm	24 cm	CC-3851-24

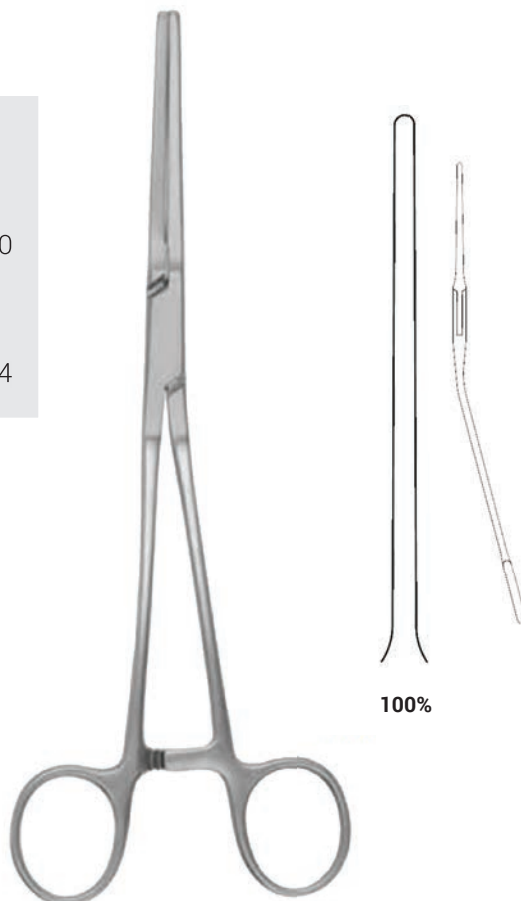

MICRO VASCULAR CLAMPS

Cooley Vascular Clamp

Description	Length	Code
Cooley Vascular Clamp Handles Straight Jaw Curved	21 cm	CC-5075-21

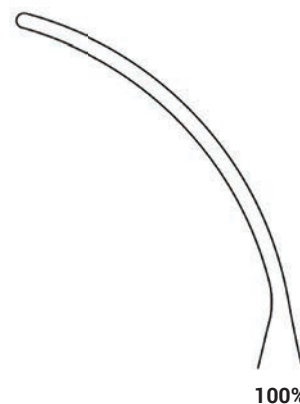

Cooley Vascular Clamp

Description	Length	Code
Cooley Vascular Clamp Handles Curved Jaw Fully Curved 10 scale line	20 cm	CC-3828-20
Cooley Vascular Clamp Handles Curved Jaw Fully Curved 11 scale line	20 cm	CC-3829-20

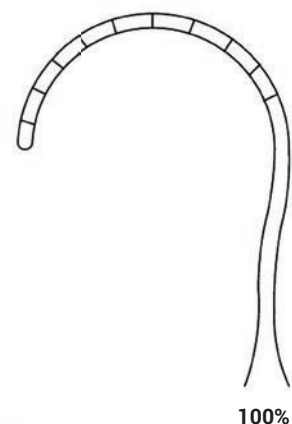

Cooley Vascular Clamp

Description	Length	Code
Cooley Vascular Clamp Handles Curved Jaw 60° 40 mm	23 cm	CC-5070-23
Cooley Vascular Clamp Handles Curved Jaw 60° 55 mm	22 cm	CC-5071-22
Cooley Vascular Clamp Handles Curved Jaw 60° 65 mm	23 cm	CC-5072-23
Cooley Vascular Clamp Handles Curved Jaw 60° 110 mm	28 cm	CC-5076-28

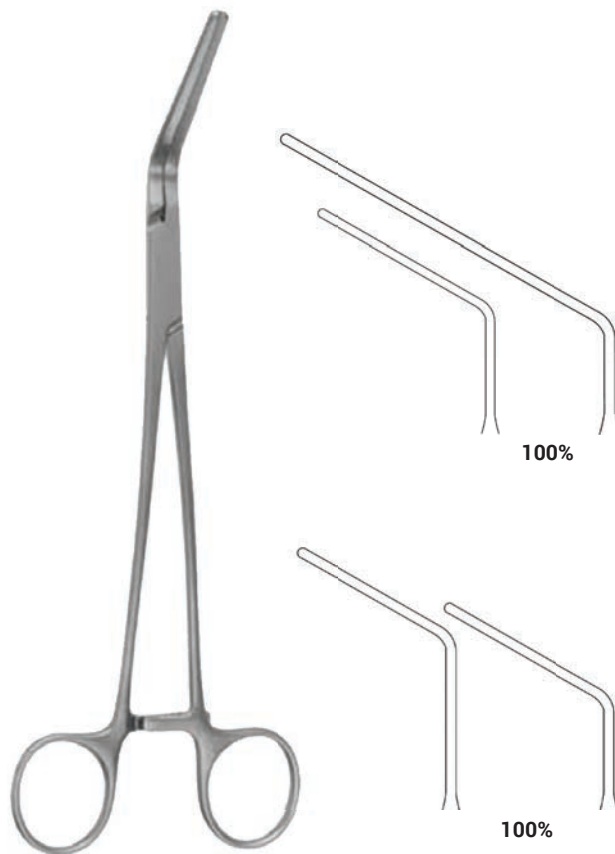

Cooley Vascular Clamp

Description	Length	Code
Cooley Vascular Clamp Handles Curved Jaw Angled	19 cm	CC-3839-19
Cooley Vascular Clamp Handles Curved Jaw Angled	23 cm	CC-3840-23
Cooley Vascular Clamp Handles Curved Jaw Angled	27 cm	CC-3841-27



MICRO VASCULAR CLAMPS

Cooley Hopkins Vascular Clamp

Description	Length	Code
Hopkins Cooley Vascular Clamp Handles Straight Jaw Angled	25 cm	CC-2596-25



Cooley Satinsky Vascular Clamp

Description	Length	Code
Cooley Satinsky Vascular Clamp Handles Curved Jaw Satinsky 35 mm	20 cm	CC-5051-20
Cooley Satinsky Vascular Clamp Handles Curved Jaw Satinsky 48 mm	21 cm	CC-5052-21
Cooley Satinsky Vascular Clamp Handles Curved Jaw Satinsky 50 mm	22 cm	CC-5053-22
Cooley Satinsky Vascular Clamp Handles Curved Jaw Satinsky 60 mm	23 cm	CC-5054-23
Cooley Satinsky Vascular Clamp Handles Curved Jaw Satinsky 70 mm	27 cm	CC-5055-27



Cooley Satinsky Vascular Clamp

Description	Length	Code
Cooley Satinsky Vascular Clamp Handles Curved Jaw Satinsky 70 mm	24 cm	CC-5056-24



Cooley Satinsky Vascular Clamp

Description	Length	Code
Cooley Satinsky Vascular Clamp Handles Straight Jaw Satinsky	24 cm	CC-5079-24



MICRO VASCULAR CLAMPS

MICRO VASCULAR CLAMPS

Cooley Vascular Clamp

Description	Length	Code
Cooley Vascular Clamp Handles/Jaw Fully Curved	20 cm	CC-5057-20
Cooley Vascular Clamp Handles/Jaw Fully Curved	23 cm	CC-5058-23
Cooley Vascular Clamp Handles/Jaw Fully Curved	27 cm	CC-5060-27



Cooley Vena Cava Vascular Clamp



Ø 6.7-20 FR
165 mm



Ø 8.0-24 FR
165 mm



Ø 8.7-26 FR
184 mm



Ø 9.3-28 FR
184 mm



Ø 10.0-30 FR
184 mm



Ø 10.7-32 FR
184 mm



Ø 11.3-34 FR
184 mm



Ø 12.0-36 FR
184 mm



Ø 12.7-38 FR
184 mm



Ø 13.3-40 FR
184 mm

Description

Cooley Vena Cava Vascular Clamp	Handles Angled 6.7-20 FR	16 cm	CC-0644-16
Cooley Vena Cava Vascular Clamp	Handles Angled 8.0-24 FR	16 cm	CC-0645-16
Cooley Vena Cava Vascular Clamp	Handles Angled 8.7-26 FR	18 cm	CC-0646-18
Cooley Vena Cava Vascular Clamp	Handles Angled 9.3-28 FR	18 cm	CC-0650-18
Cooley Vena Cava Vascular Clamp	Handles Angled 10.7-32 FR	18 cm	CC-0652-18
Cooley Vena Cava Vascular Clamp	Handles Angled 11.3-34 FR	18 cm	CC-0653-18
Cooley Vena Cava Vascular Clamp	Handles Angled 10.0-30 FR	18 cm	CC-0651-18
Cooley Vena Cava Vascular Clamp	Handles Angled 12.0-36 FR	18 cm	CC-0654-18
Cooley Vena Cava Vascular Clamp	Handles Angled 12.7-38 FR	18 cm	CC-0657-18
Cooley Vena Cava Vascular Clamp	Handles Angled 13.3-40 FR	18 cm	CC-0659-18

Length

Code

16 cm	CC-0644-16
16 cm	CC-0645-16
18 cm	CC-0646-18
18 cm	CC-0650-18
18 cm	CC-0652-18
18 cm	CC-0653-18
18 cm	CC-0651-18
18 cm	CC-0654-18
18 cm	CC-0657-18
18 cm	CC-0659-18



MICRO VASCULAR CLAMPS

Castaneda Neonatal Vascular Clamp

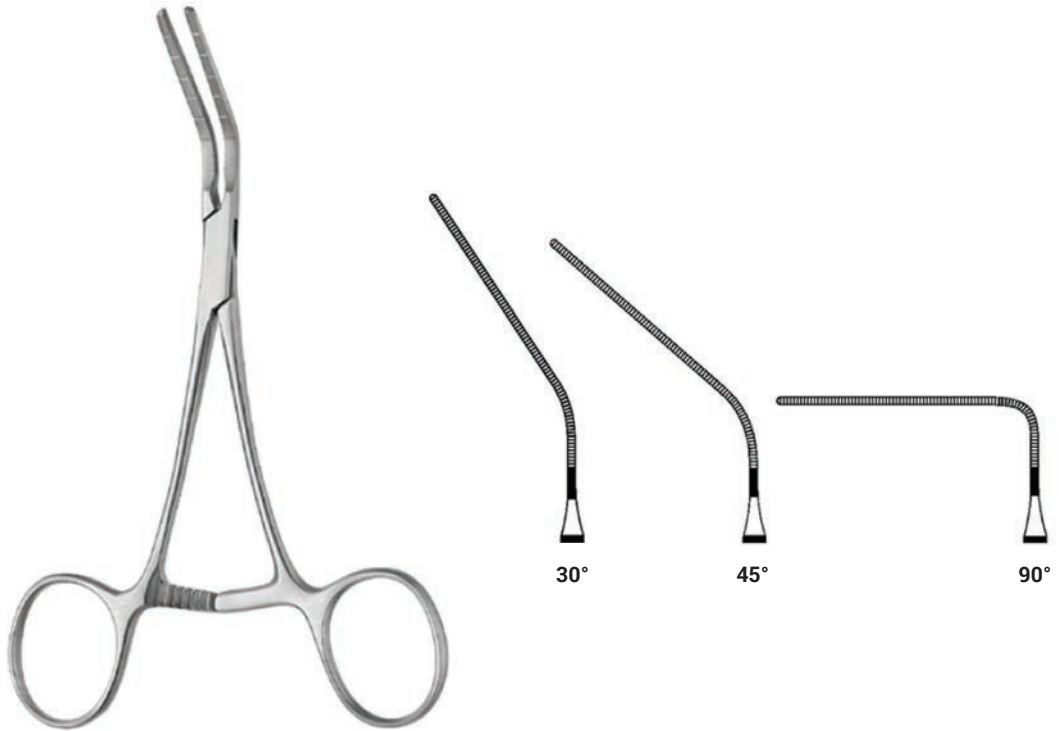

Description

Castaneda Neonatal Vascular Clamp
 Castaneda Neonatal Vascular Clamp
 Castaneda Neonatal Vascular Clamp

Length

11 cm
 12 cm
 12 cm

Code

CC-1543-11
 CC-1541-12
 CC-1542-12

Castaneda DeBakey Neonatal Vascular Clamp

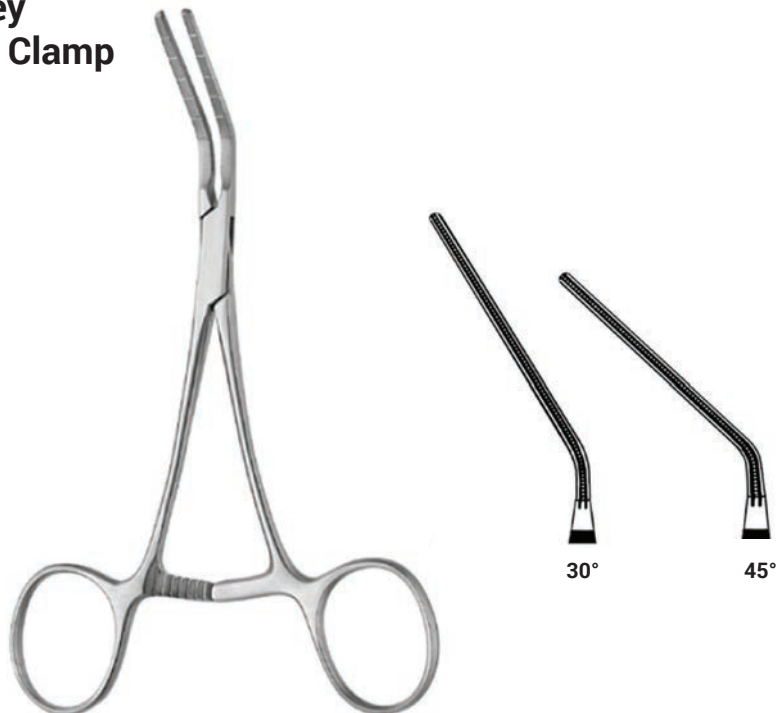

Description

Castaneda DeBakey Neonatal Vascular Clamp
 Castaneda DeBakey Neonatal Vascular Clamp

Length

12 cm
 12 cm

Code

CC-1545-12
 CC-1546-12

Castaneda Neonatal Vascular Clamp

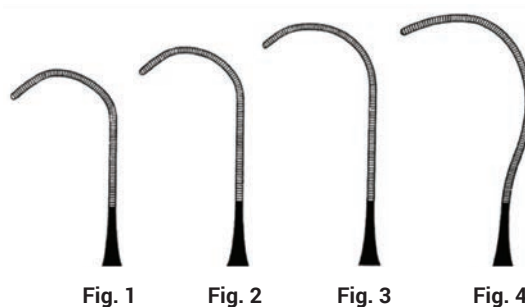

Description

Castaneda Neonatal Vascular Clamp
 Castaneda Neonatal Vascular Clamp
 Castaneda Neonatal Vascular Clamp
 Castaneda Neonatal Vascular Clamp

Length

Code

11 cm CC-1548-11
 12 cm CC-1549-12
 12 cm CC-1550-12
 12 cm CC-1551-12



MICRO VASCULAR CLAMPS

MICRO VASCULAR CLAMPS

Castaneda Neonatal Vascular Clamp

Description	Length	Code
Castaneda Neonatal Vascular Clamp Handles/Jaw Straight	12 cm	CC-6311-12
Castaneda Neonatal Vascular Clamp Handles Straight/Jaw 15°	12 cm	CC-6332-12
Castaneda Neonatal Vascular Clamp Handles Straight/Jaw 35°	12 cm	CC-6312-12
Castaneda Neonatal Vascular Clamp Handles Straight Jaw Slightly Curved	12 cm	CC-6321-12
Castaneda Neonatal Vascular Clamp Handles Straight Jaw Satinsky 90°	12 cm	CC-6322-12
Castaneda Neonatal Vascular Clamp Handles Straight Jaw Satinsky 90°	12 cm	CC-6323-12

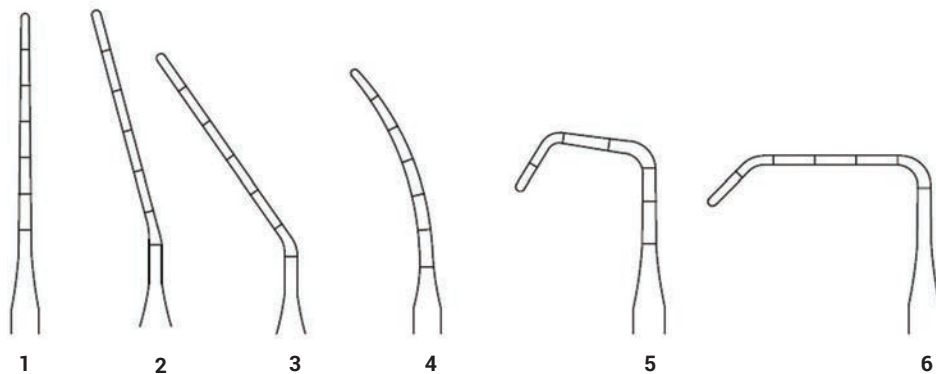

Castaneda Neonatal Vascular Clamp

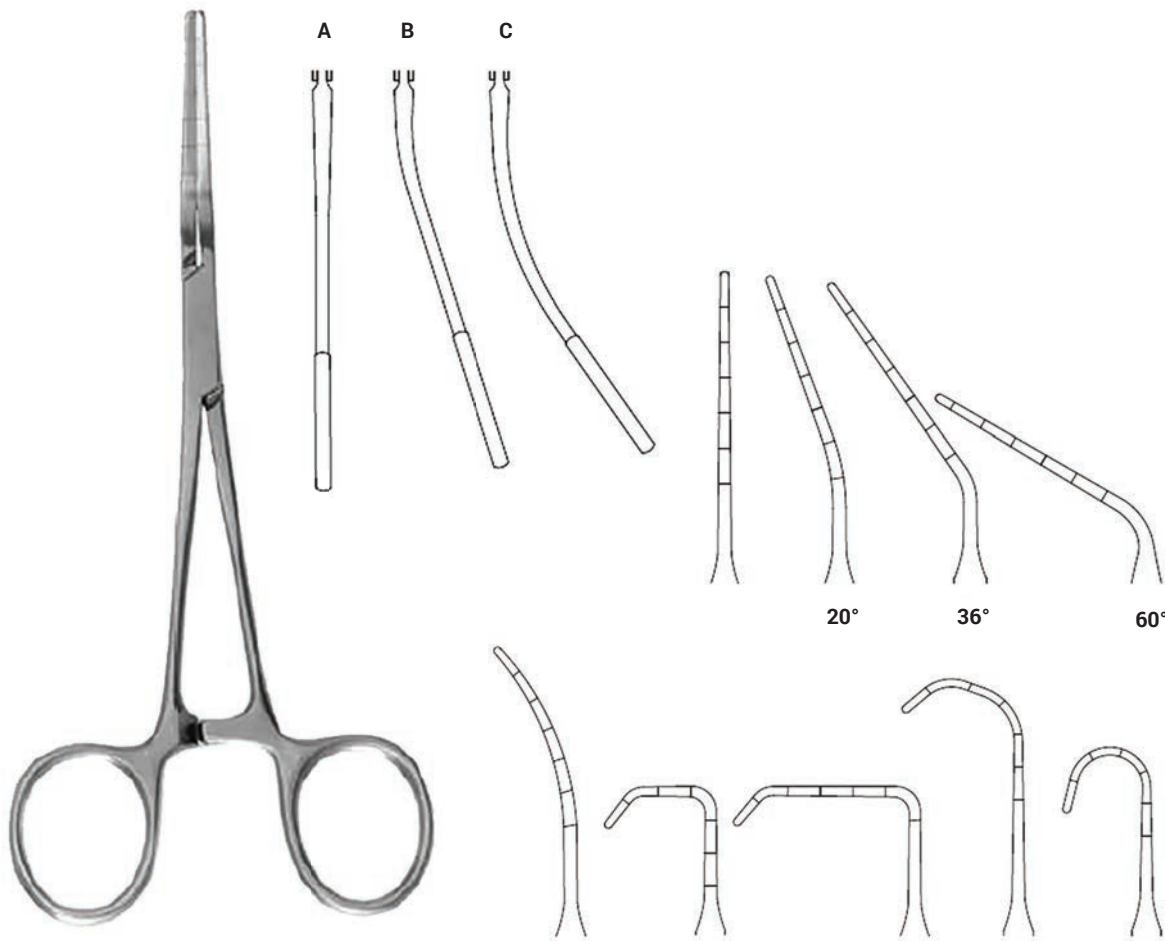

Description	Length	Code
Castaneda Neonatal Vascular Clamp Handles Curved Jaw Straight	12 cm	CC-6360-12
Castaneda Neonatal Vascular Clamp Handles Curved Jaw 15°	12 cm	CC-6361-12
Castaneda Neonatal Vascular Clamp Handles Curved Jaw 30°	12 cm	CC-6362-12
Castaneda Neonatal Vascular Clamp Handles Curved Jaw 50°	12 cm	CC-6316-12
Castaneda Neonatal Vascular Clamp Handles Curved Jaw 60°	12 cm	CC-6363-12
Castaneda Neonatal Vascular Clamp Handles Curved Jaw 85°	12 cm	CC-6314-12
Castaneda Neonatal Vascular Clamp Handles Curved Jaw Slightly Curved	12 cm	CC-6364-12
Castaneda Neonatal Vascular Clamp Handles Curved Jaw Curved	12 cm	CC-6315-12
Castaneda Neonatal Vascular Clamp Handles Curved Jaw Satinsky Small	12 cm	CC-6317-12
Castaneda Neonatal Vascular Clamp Handles Curved Jaw Satinsky Medium	12 cm	CC-6318-12
Castaneda Neonatal Vascular Clamp Handles Curved Jaw Satinsky Large	12 cm	CC-6319-12
Castaneda Neonatal Vascular Clamp Handles Curved Jaw Satinsky 90° Small	12 cm	CC-6365-12
Castaneda Neonatal Vascular Clamp Handles Curved Jaw Satinsky 90° Large	12 cm	CC-6366-12
Castaneda Neonatal Vascular Clamp Handles Curved Jaw Fully Curved 20 mm	12 cm	CC-6367-12
Castaneda Neonatal Vascular Clamp Handles Curved Jaw Fully Curved 15 mm	12 cm	CC-6368-12

Castaneda Paediatric Clamp

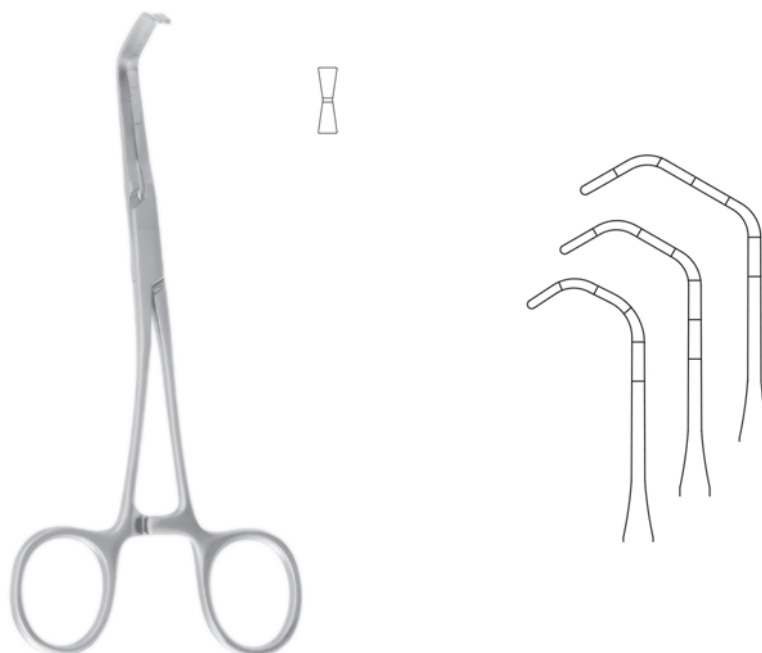

Description	Length	Code
Handles Curved, Jaw Sat. Curved, Small Jaw 18 mm	15 cm	CC-6460-15
Handles Curved, Jaw Sat. Curved, Medium Jaw 20 mm	15 cm	CC-6437-15
Handles Curved, Jaw Sat. Curved, Large Jaw 23 mm	15 cm	CC-6461-15

Castaneda Paediatric Clamp

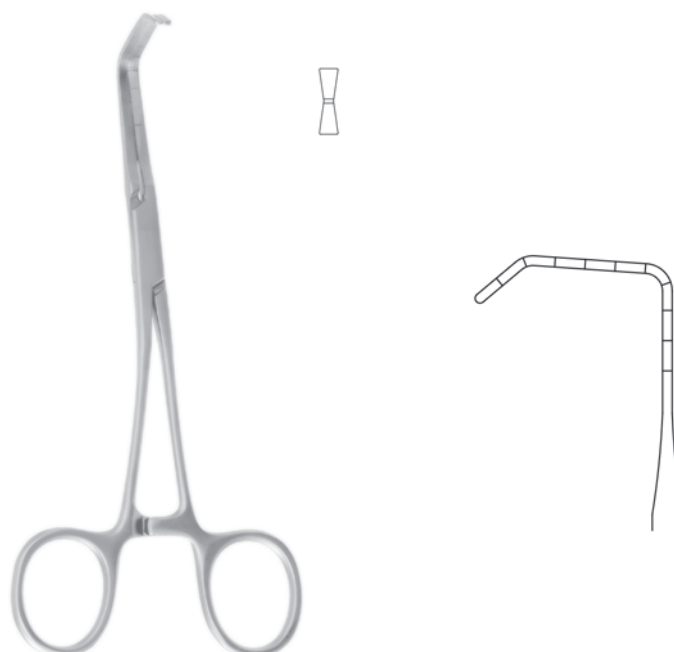

Description	Length	Code
Castaneda Paediatric Clamp Handles Curved, Jaw Sat. 86°	16 cm	CC-6403-16

Castaneda Paediatric Clamp

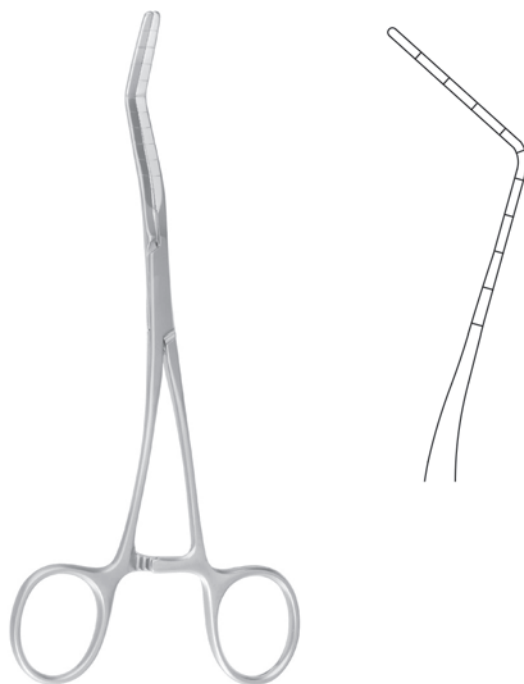

Description

Handles Curved, Jaw Ang. Backwards, B Scale Lines

Length

17 cm

Code

CC-4859-17

Castaneda Paediatric Clamp



Description

Castaneda Paediatric Clamp Handles Curved, Jaw Sat. 65°

Length

17 cm

Code

CC-6404-17

Titanium Micro Kitzmiller Neonatal Vascular Clamp



Description

Titanium Micro Kitzmiller Neonatal Vascular Clamp Jaw Left 23 mm
 Titanium Micro Kitzmiller Neonatal Vascular Clamp Jaw Right 23 mm

Length

11 cm CC-2330-11
 11 cm CC-2331-11

Code

DeBakey Titanium Neonatal Vascular Clamp



Description

DeBakey Titanium Neonatal Vascular Clamp Slightly Angled Shanks 14 mm Jaw
 DeBakey Titanium Neonatal Vascular Clamp Straight Shanks 14 mm Jaw
 DeBakey Titanium Neonatal Vascular Clamp Slightly Angled Shanks 16 mm Jaw
 DeBakey Titanium Neonatal Vascular Clamp Slightly Angled Shanks 22 mm Jaw
 DeBakey Titanium Neonatal Vascular Clamp Slightly Angled Shanks 20 mm Jaw
 DeBakey Titanium Neonatal Vascular Clamp Straight Shanks 26 mm Jaw

Length

10 cm CC-2332-10
 10 cm CC-2333-10
 10 cm CC-2334-10
 12 cm CC-2335-12
 12 cm CC-2336-12
 12 cm CC-2337-12

Code

DeBakey Titanium Neonatal Vascular Clamp

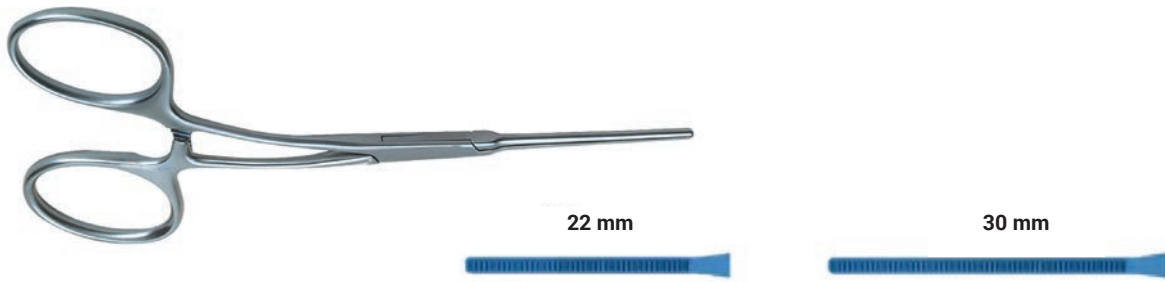

Description	Length	Code
DeBakey Titanium Neonatal Vascular Clamp Angled Shanks 22 mm Jaw	10 cm	CC-2322-10
DeBakey Titanium Neonatal Vascular Clamp Straight Shanks 30 mm Jaw	12 cm	CC-2320-12
DeBakey Titanium Neonatal Vascular Clamp Slightly Angled Shanks 30 mm Jaw	12 cm	CC-2321-12
DeBakey Titanium Neonatal Vascular Clamp Angled Shanks 30 mm Jaw	12 cm	CC-2323-12

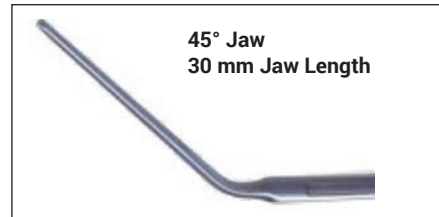
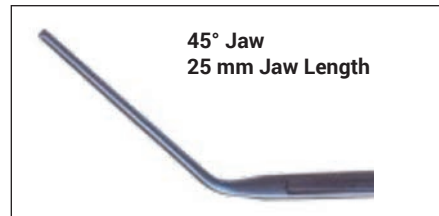

DeBakey Titanium Neonatal Vascular Clamp

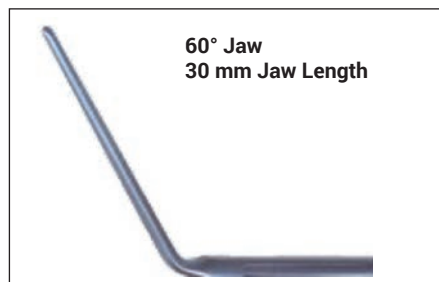
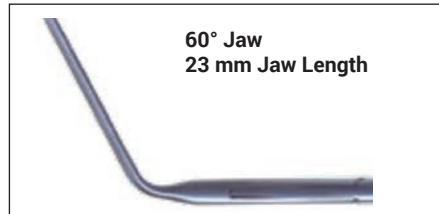

Description	Length	Code
DeBakey Titanium Neonatal Vascular Clamp Straight Shanks 45° 25 mm Jaw	10 cm	CC-2324-10
DeBakey Titanium Neonatal Vascular Clamp Straight Shanks 45° 30 mm Jaw	12 cm	CC-2325-12
DeBakey Titanium Neonatal Vascular Clamp Straight Shanks 60° 23 mm Jaw	10 cm	CC-2326-10
DeBakey Titanium Neonatal Vascular Clamp Straight Shanks 60° 30 mm Jaw	12 cm	CC-2327-12
DeBakey Titanium Neonatal Vascular Clamp Straight Shanks 90° 23 mm Jaw	10 cm	CC-2328-10
DeBakey Titanium Neonatal Vascular Clamp Straight Shanks 90° 30 mm Jaw	12 cm	CC-2329-12

MICRO VASCULAR CLAMPS

MICRO VASCULAR CLAMPS

DeBakey Ultralight Paediatric Vascular Clamp 1.4 mm Jaw Tip

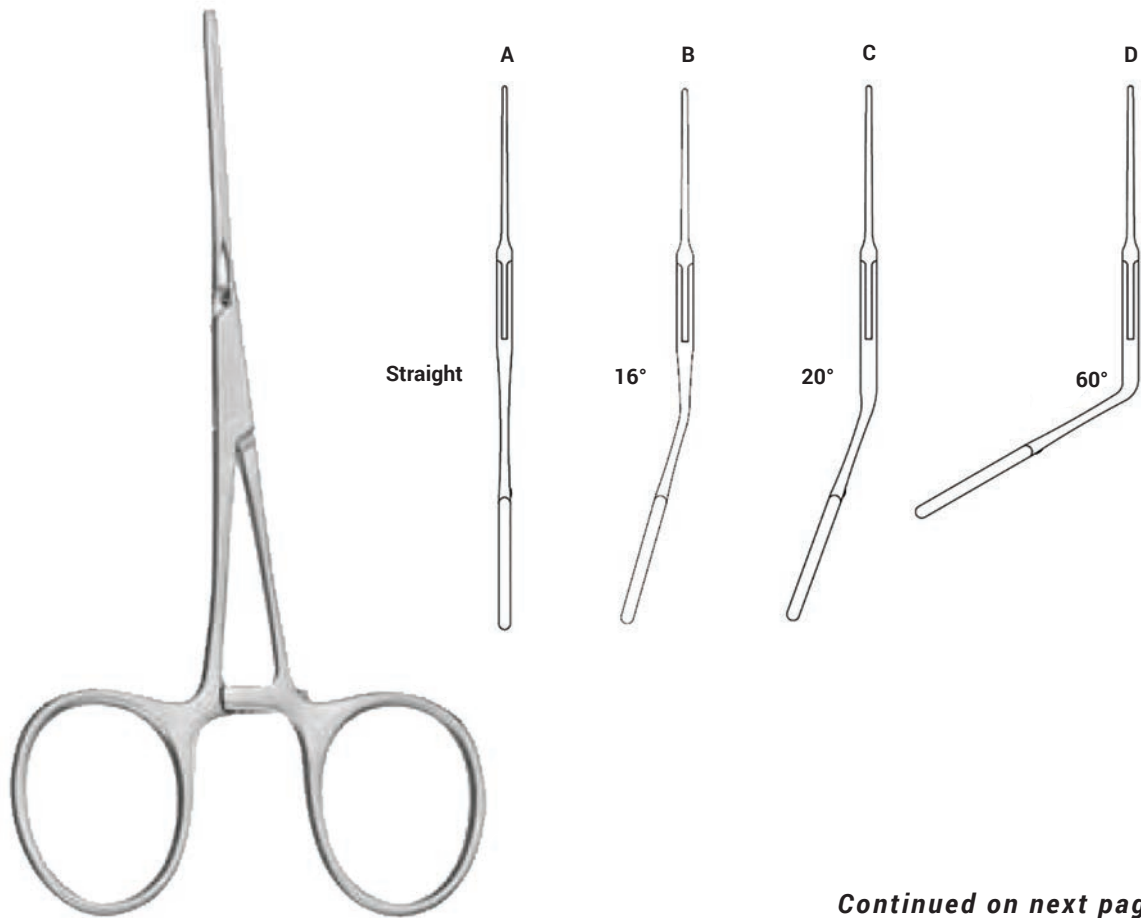

Continued on next page



DeBakey Ultralight Paediatric Vascular Clamp 1.4 mm Jaw Tip

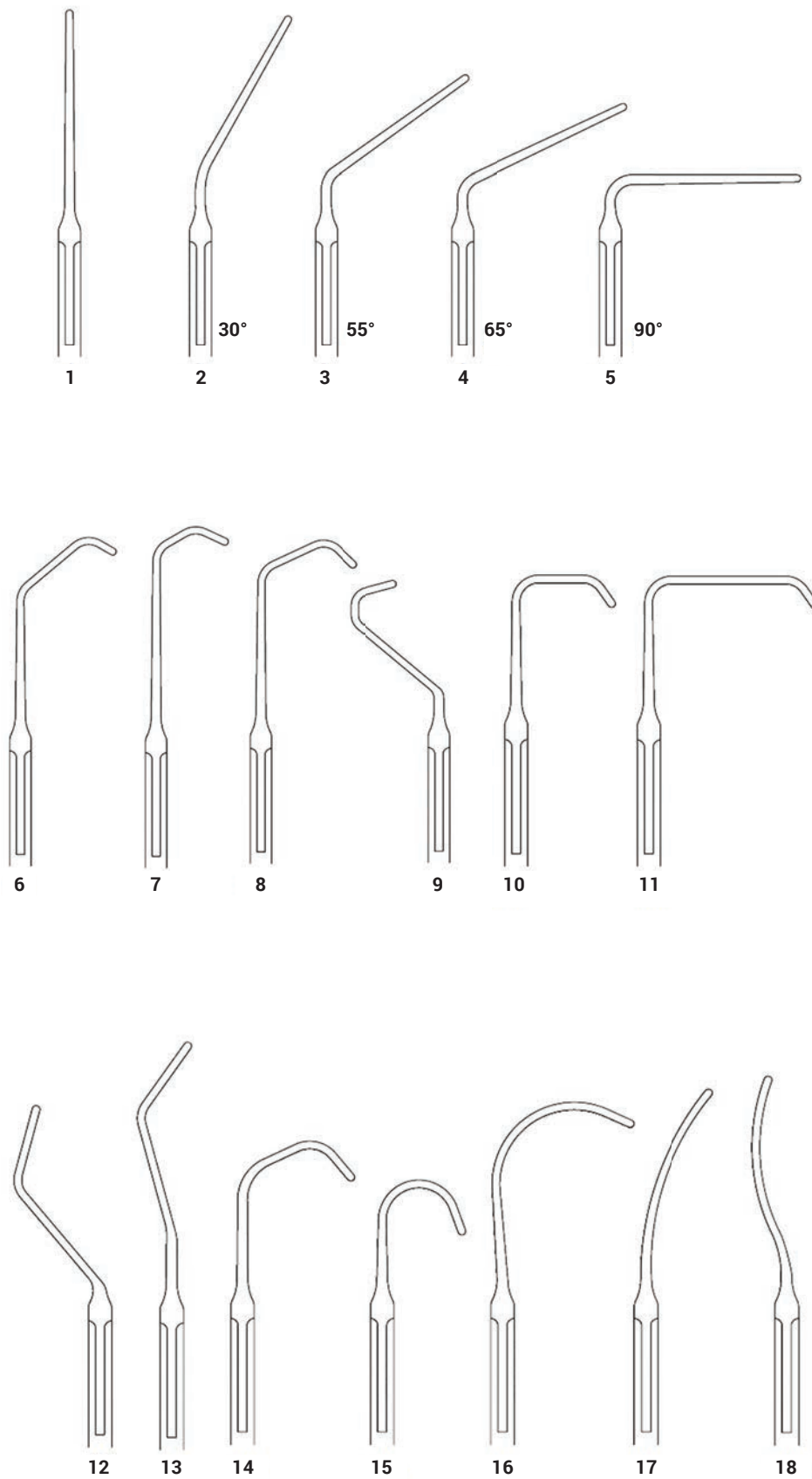

MICRO VASCULAR CLAMPS

DeBakey Ultralight Paediatric Vascular Clamp 1.4 mm Jaw Tip

A	Straight Handle DeBakey	B	16° Angled Handle	C	20° Angled Handle	D	60° Angled Handle
1	CC-2420-10	1	CC-2400-10	1	CC-2440-12	1	CC-2460-12
2	CC-2421-10	2	CC-2401-10	2	CC-2441-12	2	CC-2461-12
3	CC-2422-10	3	CC-2402-10	3	CC-2442-12	3	CC-2462-12
4	CC-2423-10	4	CC-2403-10	4	CC-2443-12	4	CC-2463-12
5	CC-2424-10	5	CC-2404-10	5	CC-2444-12	5	CC-2464-12
6	CC-2425-10	6	CC-2405-10	6	CC-2445-12	6	CC-2465-12
7	CC-2426-10	7	CC-2406-10	7	CC-2446-12	7	CC-2466-12
8	CC-2427-10	8	CC-2407-10	8	CC-2447-12	8	CC-2467-12
9	CC-2428-10	9	CC-2408-10	9	CC-2448-12	9	CC-2468-12
10	CC-2429-10	10	CC-2409-10	10	CC-2449-12	10	CC-2469-12
11	CC-2430-10	11	CC-2410-10	11	CC-2450-12	11	CC-2470-12
12	CC-2431-10	12	CC-2411-10	12	CC-2451-12	12	CC-2471-12
13	CC-2432-10	13	CC-2412-10	13	CC-2452-12	13	CC-2472-12
14	CC-2433-10	14	CC-2413-10	14	CC-2453-12	14	CC-2473-12
15	CC-2434-10	15	CC-2414-10	15	CC-2454-12	15	CC-2474-12
16	CC-2435-10	16	CC-2415-10	16	CC-2455-12	16	CC-2475-12
17	CC-2436-10	17	CC-2416-10	17	CC-2456-12	17	CC-2476-12
18	CC-2437-10	18	CC-2417-10	18	CC-2457-12	18	CC-2477-12



DeBakey Ring Handle Bulldog Clamp Delicate, Jaw Tip: Ø 1,6 mm

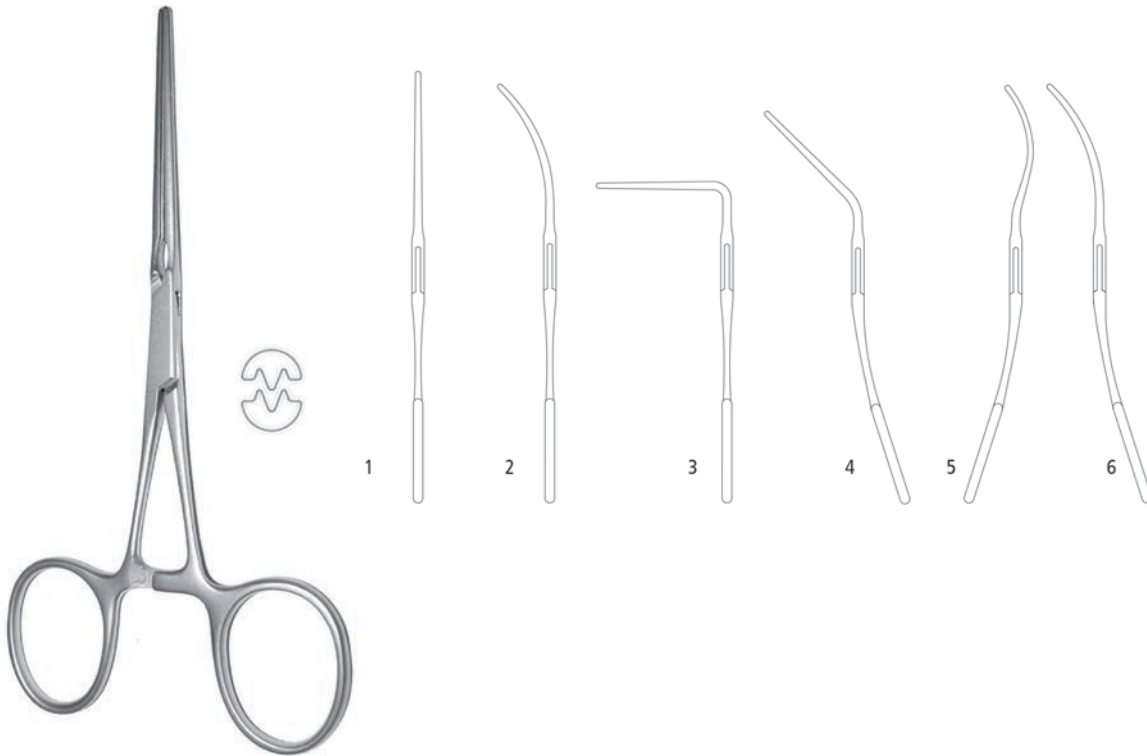

Description

Handles Straight, Jaw 90°

Handles Curved, Jaw 45°

Handles Curved, Jaw Spoon Shaped

Handles Curved, Jaw Slightly Curved, S-Form

Handles Straight, Jaw Straight

Handles Straight, Jaw Slightly Curved

Length

10 cm

12 cm

13 cm

13 cm

13 cm

13 cm

Code

CC-2192-10

CC-2189-12

CC-2194-12

CC-2195-12

CC-2182-13

CC-2186-13



MICRO VASCULAR CLAMPS

DeBakey Ring Handle Bulldog Clamp Delicate, Jaw Tip: Ø 1,6 mm

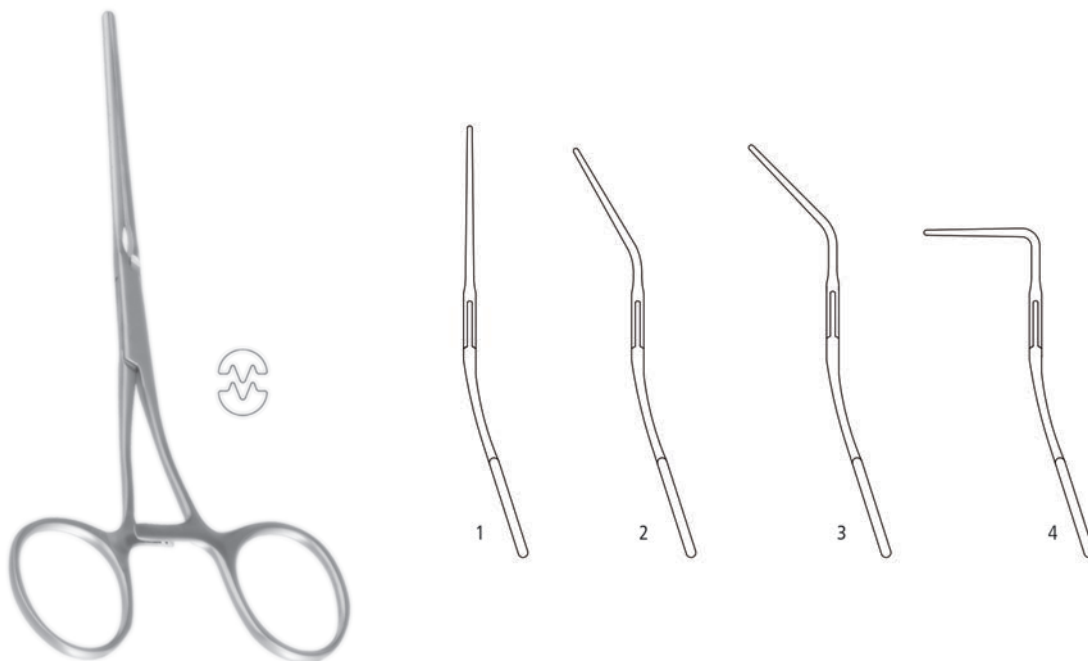
**Description**

Handles Curved, 7 Scale lines on Jaw, Jaw 90°

Length

10 cm

Code

CC-2223-10

Handles Curved, 7 Scale lines on Jaw, Jaw 30°

12 cm

CC-2221-12

Handles Curved, 7 Scale lines on Jaw, Jaw Straight

13 cm

CC-2220-13

Handles Curved, 7 Scale lines on Jaw, Jaw 45°

13 cm

CC-2222-13



DeBakey Vascular Clamp

Description	Length	Code
DeBakey Vascular Clamp Handles Curved Jaw Angled 90°	13 cm	CC-3739-13
DeBakey Vascular Clamp Handles Curved Jaw Angled 60°	15 cm	CC-3737-15
DeBakey Vascular Clamp Handles Curved Jaw Angled 30°	16 cm	CC-3735-16



MICRO VASCULAR CLAMPS

DeBakey Satinsky Paediatric Vascular Clamp

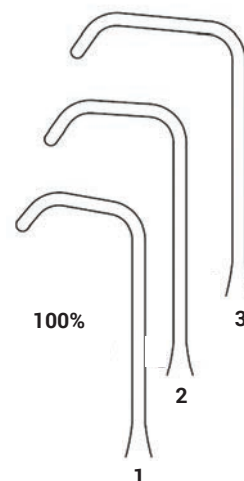

Description

DeBakey Satinsky Paediatric Vascular Clamp Handles Curved Jaw 14 mm
 DeBakey Satinsky Paediatric Vascular Clamp Handles Curved Jaw 18 mm
 DeBakey Satinsky Paediatric Vascular Clamp Handles Curved Jaw 23 mm

Length

14 cm
 14 cm
 14 cm

Code

CC-2196-14
 CC-2197-14
 CC-2198-14

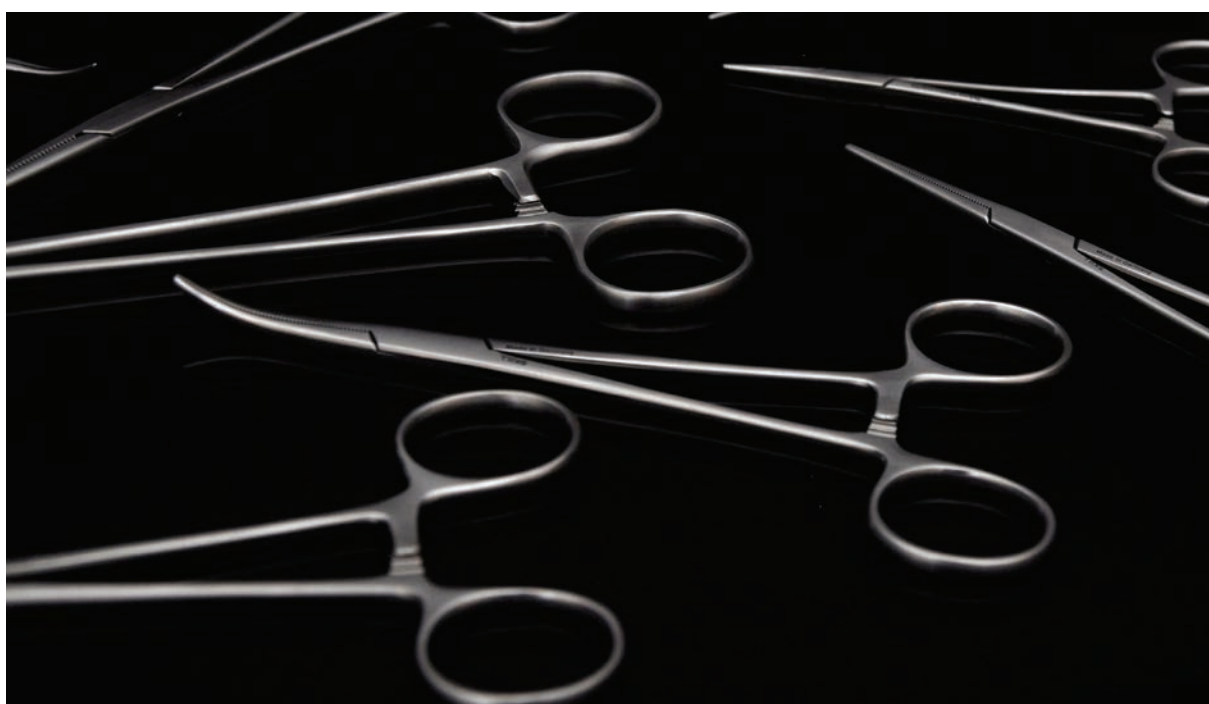

DeBakey Paediatric Vascular Clamp

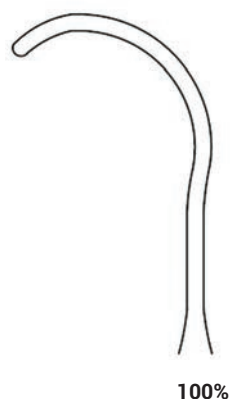

Description

DeBakey Paediatric Vascular Clamp Handles Curved Jaw S-form 25 mm

Length

14 cm

Code

CC-2199-14

DeBakey Mini Beck Paediatric Vascular Clamp

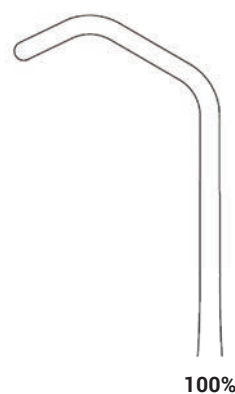

Description

DeBakey Mini Beck Paediatric Vascular Clamp Handles Straight Jaw 65°

Length

16 cm

Code

CC-3750-16

DeBakey Peripheral Vascular Clamp

Description	Length	Code
DeBakey Peripheral Vascular Clamp Handles Straight Jaw Curved	16 cm	CC-2550-16

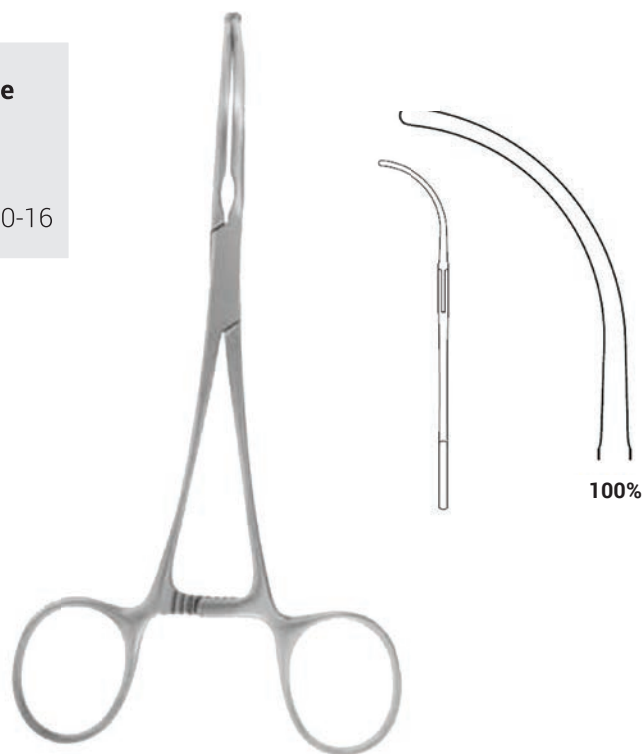

DeBakey Vascular Clamp

Description	Length	Code
DeBakey Vascular Clamp Handles Curved Jaw 57° 53 mm	17 cm	CC-2535-17



DeBakey Glover Vascular Clamp

Description	Length	Code
DeBakey Glover Vascular Clamp Handles Straight Jaw Straight	17 cm	CC-3752-17
DeBakey Glover Vascular Clamp Handles Straight Jaw Curved	17 cm	CC-3754-17



DeBakey Aorta Clamp

Description	Length	Code
DeBakey Diethrich Aorta Clamp Handles Angled Jaw Satinsky	17 cm	CC-2587-17
DeBakey Ochsner Aorta Clamp Handles Angled Jaw Satinsky	22 cm	CC-2586-22

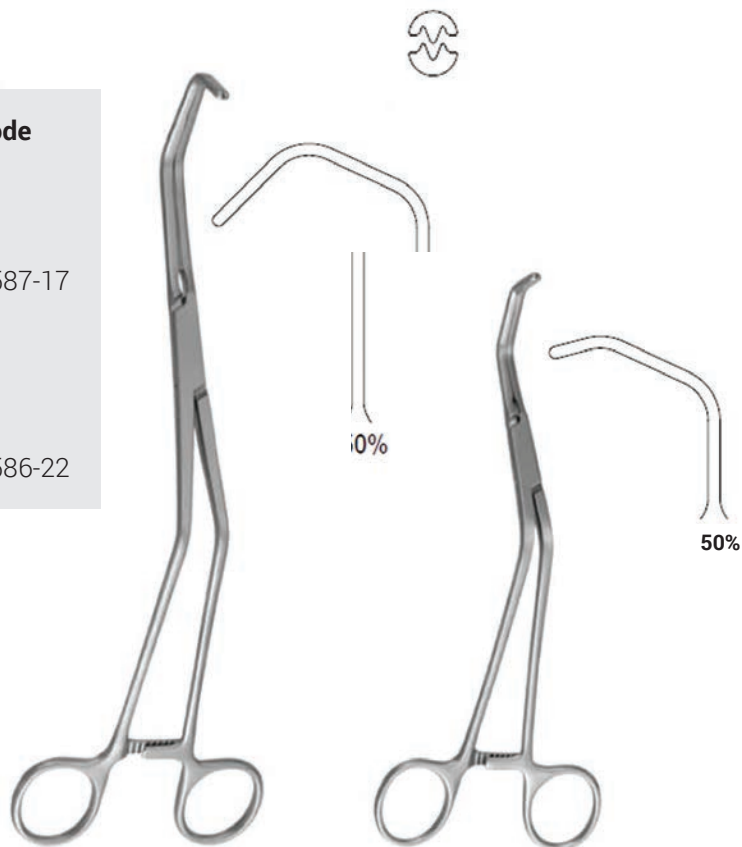

DeBakey Derra Paediatric Vascular Clamp

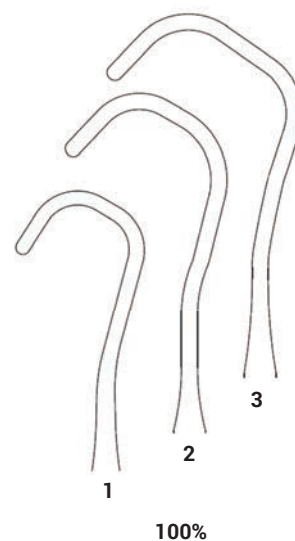

Description

DeBakey Derra Paediatric Vascular Clamp Handles Curved Jaw Small

DeBakey Derra Paediatric Vascular Clamp Handles Curved Jaw Medium

DeBakey Derra Paediatric Vascular Clamp Handles Curved Jaw Large

Length

17 cm

17 cm

17 cm

Code

CC-3135-17

CC-3136-17

CC-3137-17



DeBakey Multi-Purpose Vascular Clamp

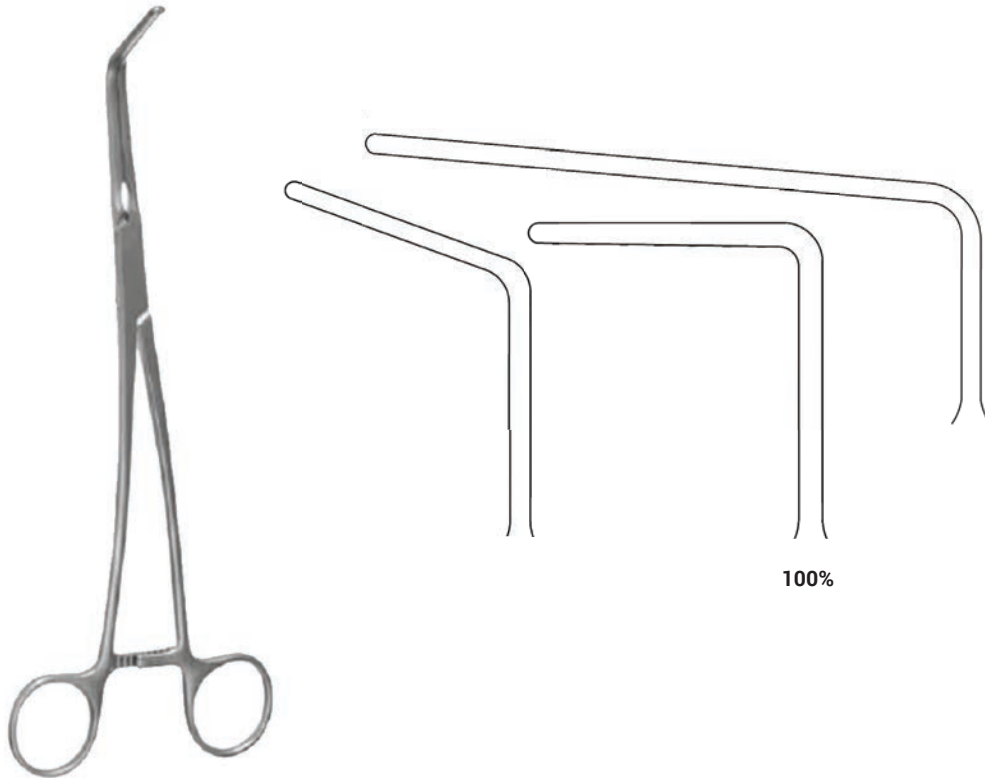

Description

Description	Length	Code
DeBakey Multi-Purpose Vascular Clamp Handles Curved Jaw 90° 65 mm	18 cm	CC-2692-18
DeBakey Multi-Purpose Vascular Clamp Handles Curved Jaw 90° 75 mm	19 cm	CC-2694-19
DeBakey Multi-Purpose Vascular Clamp Handles Curved Jaw 90° 45 mm	22 cm	CC-2690-22
DeBakey Multi-Purpose Vascular Clamp Handles Curved Jaw 70°	23 cm	CC-2680-23
DeBakey Multi-Purpose Vascular Clamp Handles Curved Jaw 95°	24 cm	CC-2696-24



MICRO VASCULAR CLAMPS

DeBakey S-form Peripheral Vascular Clamp

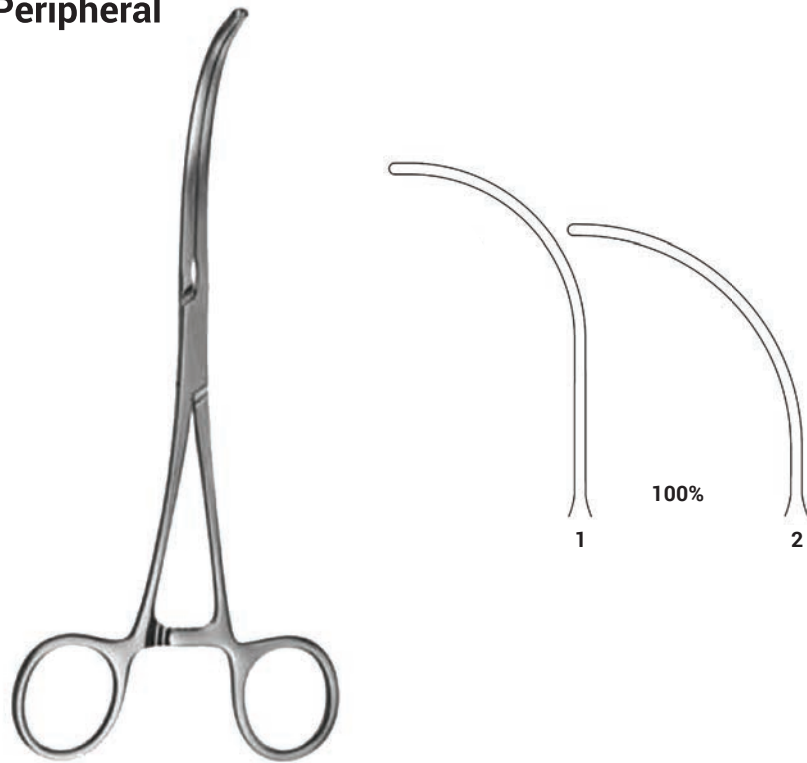

Description	Length	Code
DeBakey S-form Peripheral Vascular Clamp Handles Curved Jaw Curved	19 cm	CC-2540-19
DeBakey S-form Peripheral Vascular Clamp Handles Curved Jaw Curved	19 cm	CC-2545-19

DeBakey Coarctation Vascular Clamp

Description	Length	Code
DeBakey Coarctation Vascular Clamp Handles Straight Jaw Straight 40 mm	20 cm	CC-2800-20
DeBakey Coarctation Vascular Clamp Handles Curved Jaw Straight 40 mm	20 cm	CC-2802-20
DeBakey Coarctation Vascular Clamp Handles Curved Jaw Straight 70 mm	22 cm	CC-2503-22
DeBakey Coarctation Vascular Clamp Handles Straight Jaw Straight 70 mm	23 cm	CC-2500-23
DeBakey Coarctation Vascular Clamp Handles Curved Jaw Straight 80 mm	25 cm	CC-2867-25
DeBakey Coarctation Vascular Clamp Handles Straight Jaw Straight 80 mm	26 cm	CC-2865-26

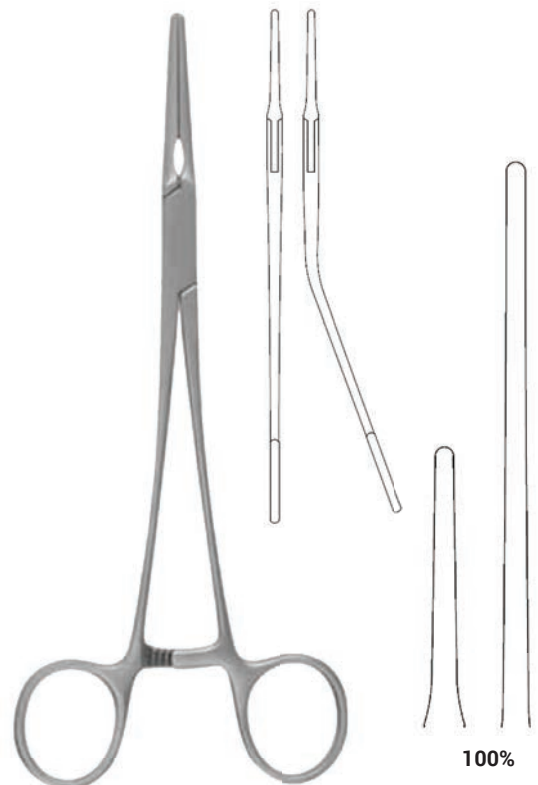

DeBakey Multi-Purpose Vascular Clamp

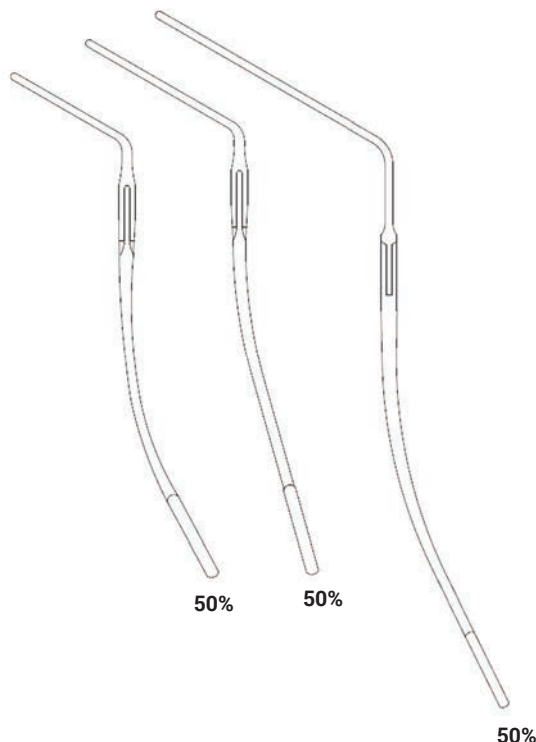

Description

DeBakey Multi-Purpose Vascular Clamp Handles Curved Jaw 60° 55 mm
 DeBakey Multi-Purpose Vascular Clamp Handles Curved Jaw 60° 70 mm
 DeBakey Multi-Purpose Vascular Clamp Handles Curved Jaw 60° 105 mm

Length

20 cm
 22 cm
 28 cm

Code

CC-2682-20
 CC-2684-22
 CC-2686-28

DeBakey Beck Vena Cava Vascular Clamp

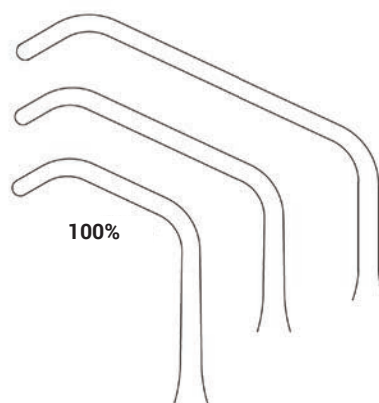

Description

DeBakey Beck Vena Cava Vascular Clamp Handles Curved Jaw 65° 30 mm
 DeBakey Beck Vena Cava Vascular Clamp Handles Curved Jaw 65° 65 mm
 DeBakey Beck Vena Cava Vascular Clamp Handles Curved Jaw 65° 45 mm

Length

20 cm
 20 cm
 21 cm

Code

CC-3100-20
 CC-3104-20
 CC-3102-21

DeBakey Satinsky Vascular Clamp

**Description**

DeBakey Satinsky Vascular Clamp Handles Curved Jaw 38 mm
 DeBakey Satinsky Vascular Clamp Handles Curved Jaw 48 mm
 DeBakey Satinsky Vascular Clamp Handles Curved Jaw 55 mm
 DeBakey Satinsky Vascular Clamp Handles Curved Jaw 60 mm
 DeBakey Satinsky Vascular Clamp Handles Curved Jaw 75 mm

Length

20 cm
 25 cm
 25 cm
 26 cm
 27 cm

Code

CC-2660-20
 CC-2662-25
 CC-2664-25
 CC-2666-26
 CC-2668-27

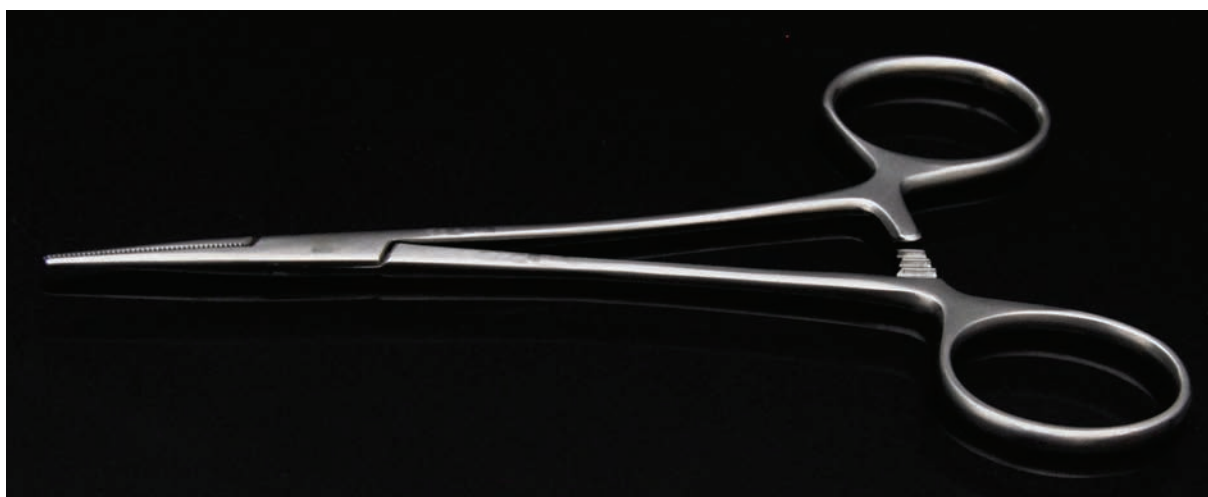

DeBakey Vascular Clamp

Description	Length	Code
DeBakey Vascular Clamp Handles Straight Jaw Curved	21 cm	CC-1561-21
DeBakey Vascular Clamp Handles Straight Jaw Curved	22 cm	CC-1562-22



DeBakey Patent Ductus Vascular Clamp

Description	Length	Code
DeBakey Vascular Clamp Handles Straight Jaw Straight	21 cm	CC-2510-21
DeBakey Vascular Clamp Handles Curved Jaw Straight	21 cm	CC-2513-21

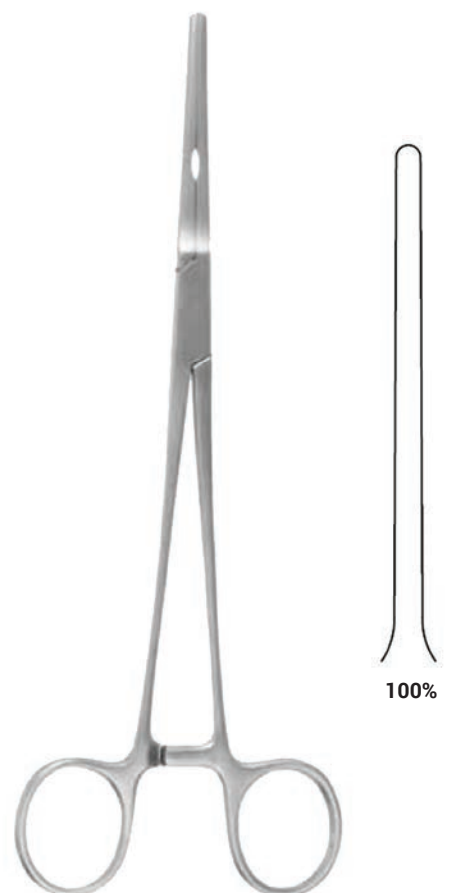

MICRO VASCULAR CLAMPS

DeBakey Glover Vascular Clamp

Description	Length	Code
DeBakey Glover Vascular Clamp Handles Straight Jaw Curved	21 cm	CC-2825-21
DeBakey Glover Vascular Clamp Handles Straight Jaw Straight	22 cm	CC-2810-22
DeBakey Glover Vascular Clamp Handles Angled Jaw Straight	22 cm	CC-2812-22
DeBakey Glover Vascular Clamp Handles Straight Jaw Spoon Shaped	22 cm	CC-2840-22
DeBakey Glover Vascular Clamp Handles Straight Jaw Curved	23 cm	CC-2827-23
DeBakey Glover Vascular Clamp Handles Straight Jaw Spoon Shaped	25 cm	CC-2842-25

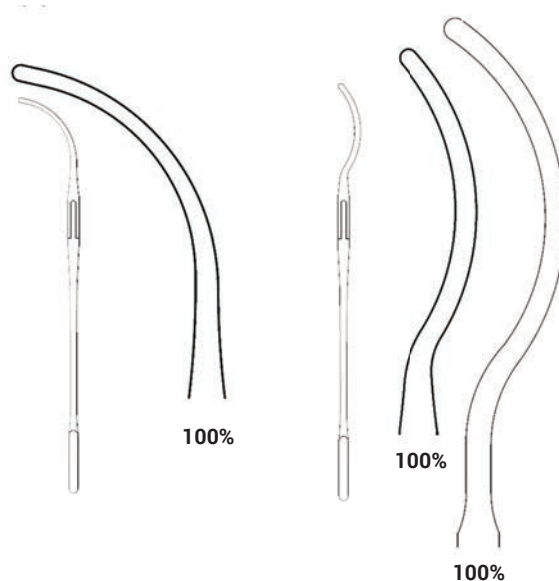
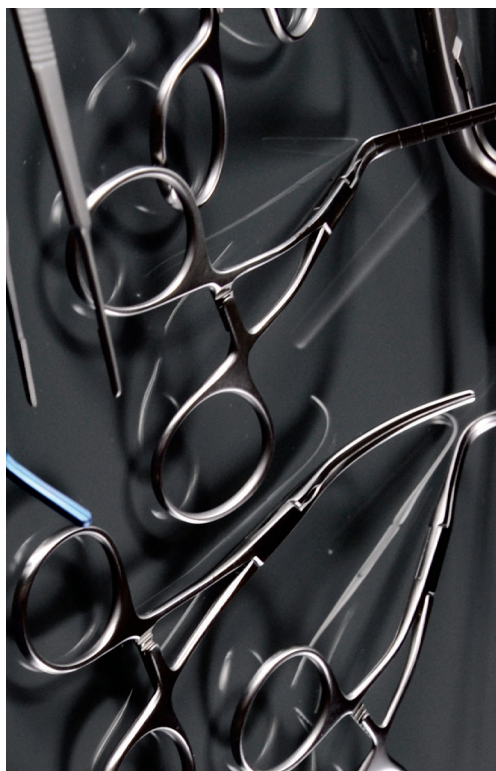

DeBakey Potts Vascular Clamp

Description	Length	Code
DeBakey Potts Vascular Clamp Handles Straight Jaw 25°	22 cm	CC-2504-22

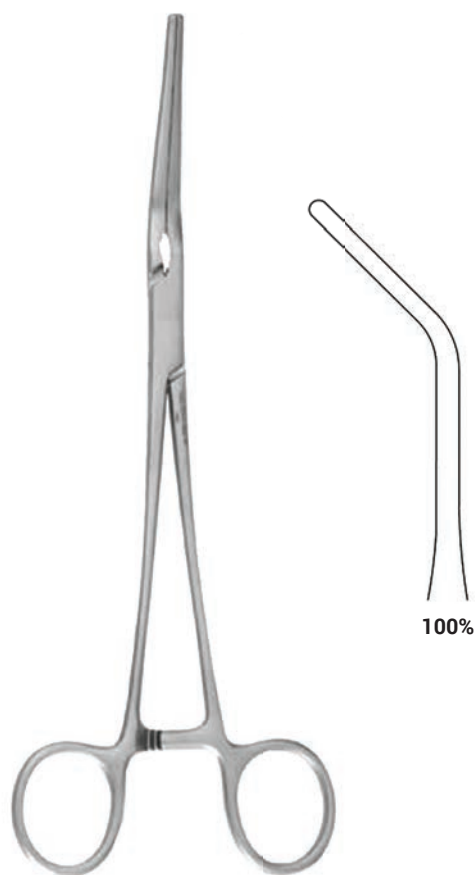

DeBakey Resection Clamp

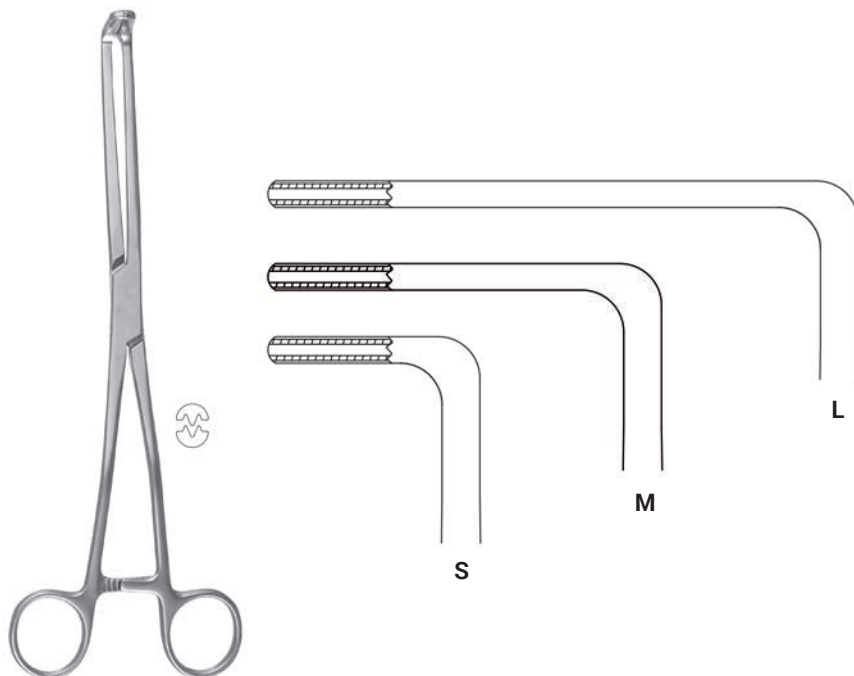

Description	Length	Code
Handles Curved, Jaw 90°, S: Jaw Length 25 mm	22 cm	CC-6046-22
Handles Curved, Jaw 90°, M: Jaw Length 50 mm	22 cm	CC-6047-22
Handles Curved, Jaw 90°, L: Jaw Length 75 mm	22 cm	CC-6048-22

MICRO VASCULAR CLAMPS

DeBakey Harken Vascular Clamp

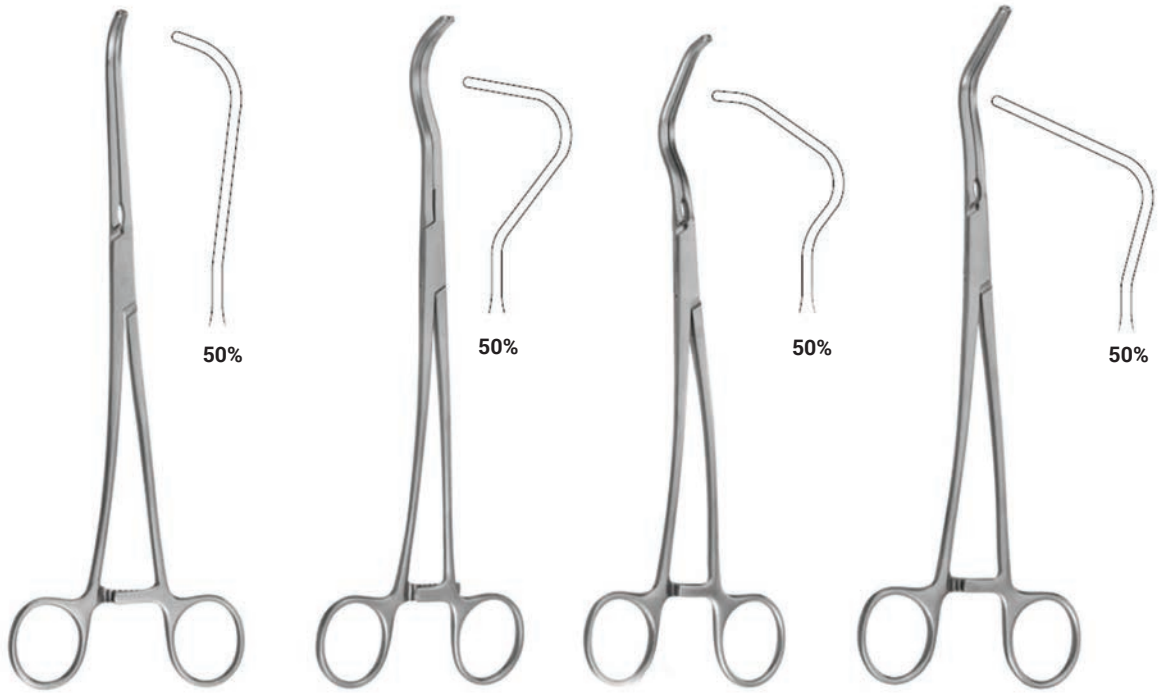

Description

DeBakey Harken Vascular Clamp Handles Curved
 DeBakey Harken Vascular Clamp Handles Curved
 DeBakey Harken Vascular Clamp Handles Curved

Length

23 cm
 24 cm
 26 cm

Code

CC-3033-23
 CC-3032-24
 CC-3031-26

DeBakey Gastro Intestinal Clamp

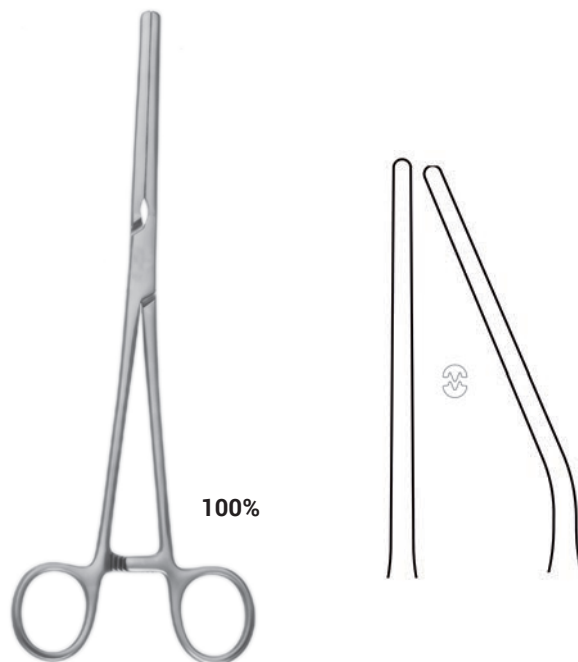

Description

DeBakey Gastro Intestinal Clamp, Handles Straight, Jaw Straight
 DeBakey Gastro Intestinal Clamp, Handles Straight, Jaw 25°

Length

23 cm
 23 cm

Code

CC-6043-23
 CC-6044-23

DeBakey C-form Vascular Clamp

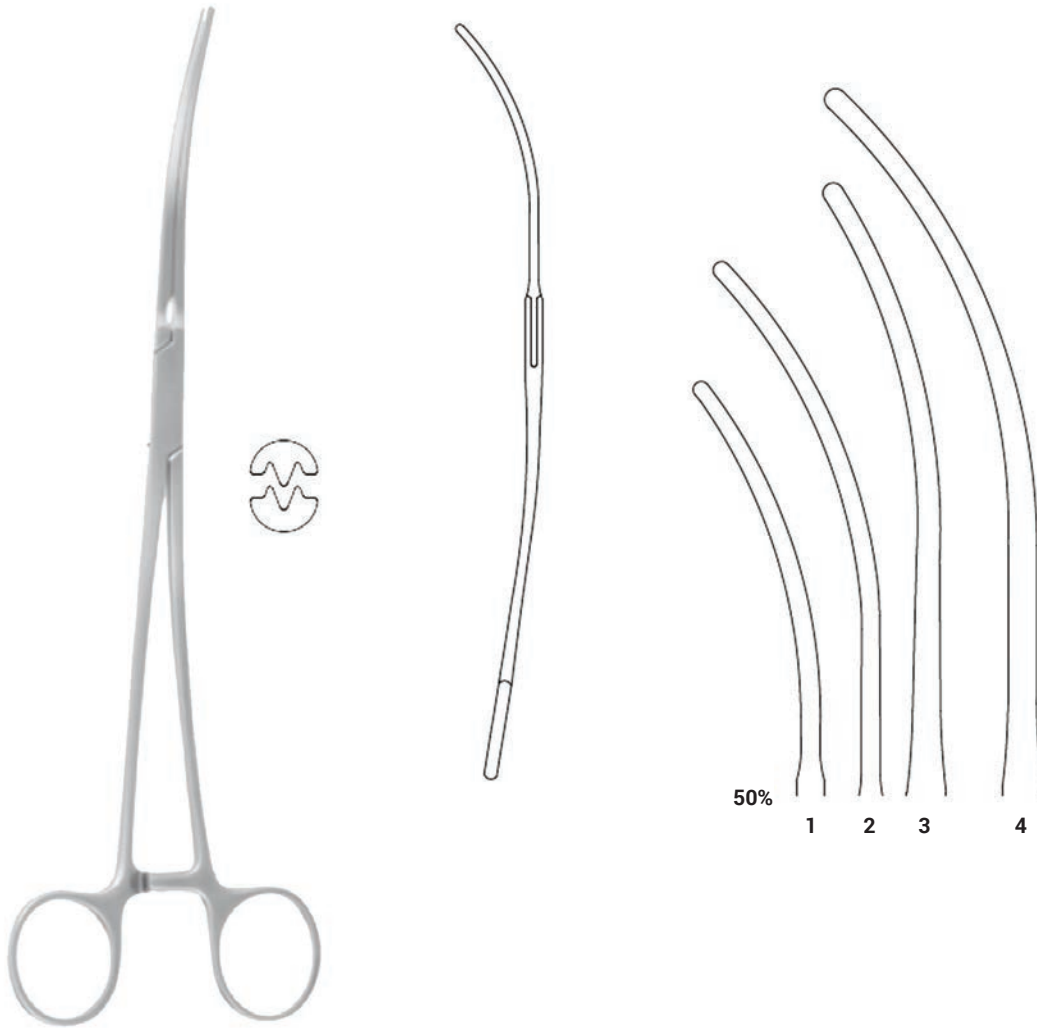

Description

- eBakey C-form Vascular Clamp Handles Curved Jaw Curved
- DeBakey C-form Vascular Clamp Handles Curved Jaw Curved
- DDeBakey C-form Vascular Clamp Handles Curved Jaw Curved
- DeBakey C-form Vascular Clamp Handles Curved Jaw Curved

Length

Code

- 24 cm CC-2602-24
- 25 cm CC-2600-25
- 30 cm CC-2636-30
- 32 cm CC-2637-32



MICRO VASCULAR CLAMPS

DeBakey Bahnson Vascular Clamp

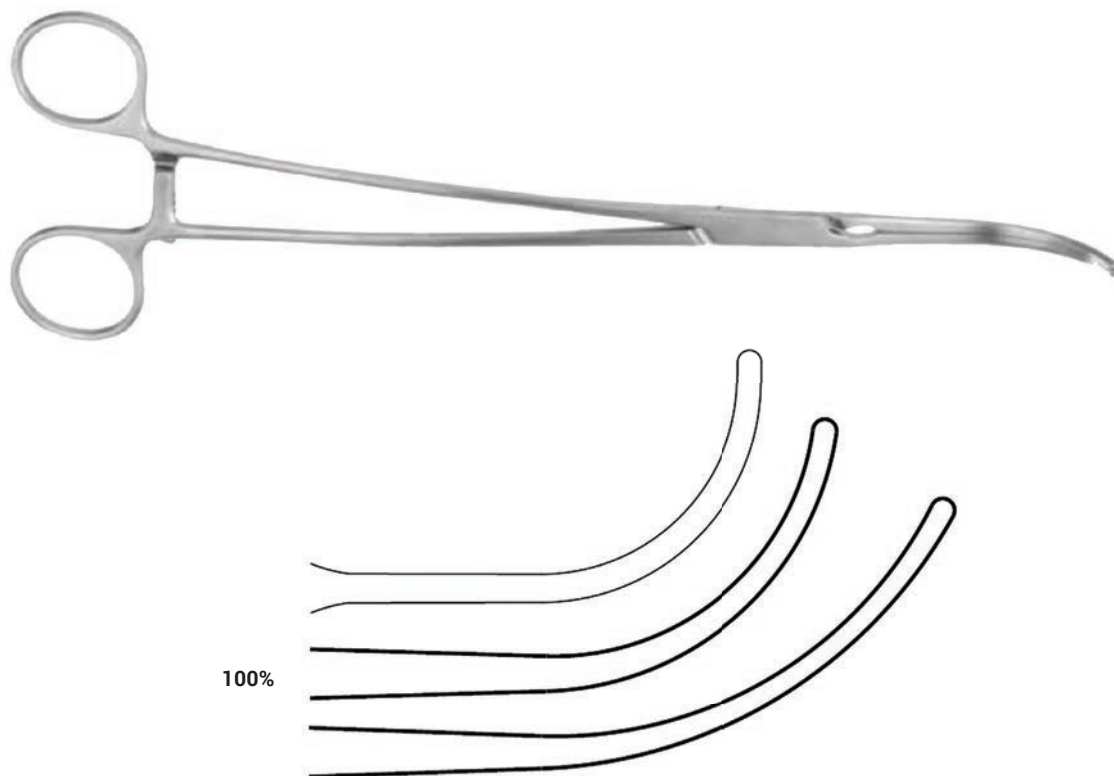
**Description**

DeBakey Bahnson Vascular Clamp Handles Curved Jaw Curved
 DeBakey Bahnson Vascular Clamp Handles Curved Jaw Curved
 DeBakey Bahnson Vascular Clamp Handles Curved Jaw Curved

Length

24 cm
 26 cm
 28 cm

Code

CC-2631-24
 CC-2630-26
 CC-2632-28



**DeBakey Weber
Anastomosis
Vascular Clamp**

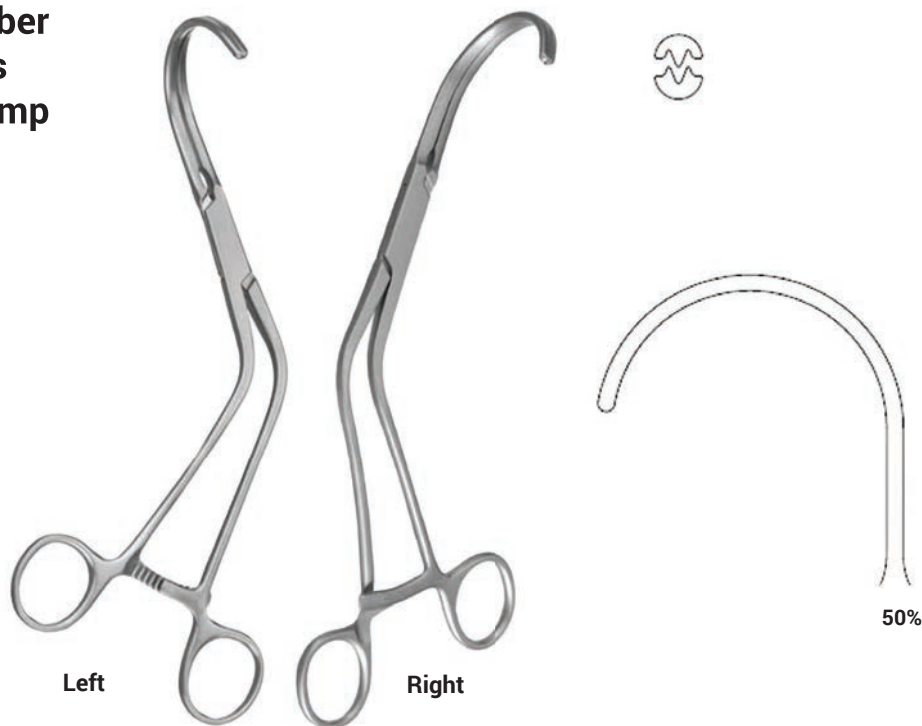

Description

DeBakey Weber Anastomosis Vascular Clamp Handles Angled Jaw Right
DeBakey Weber Anastomosis Vascular Clamp Handles Angled Jaw Left

Length

24 cm
24 cm

Code

CC-2855-24
CC-2856-24

**DeBakey Semb
Vascular Clamp**



Description

DeBakey Semb Vascular Clamp Handles Curved Jaw Fully Curved

Length

25 cm

Code

CC-2635-25

DeBakey Vena Cava Vascular Clamp

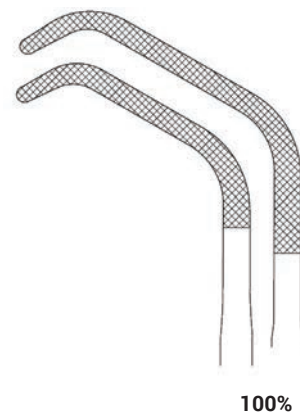
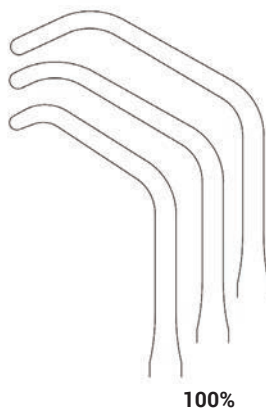
**Description**

DeBakey Vena Cava Vascular Clamp Handles Curved Jaw 60° Small

Length

25 cm

Code

CC-3004-25

DeBakey Vena Cava Vascular Clamp Handles Curved Jaw 60° Medium

26 cm

CC-3002-26

DeBakey Vena Cava Vascular Clamp Handles Curved Jaw 60° Large

26 cm

CC-3000-26

Criss-Cross Vena Cava Vascular Clamp Handles Curved Jaw 60° Small

27 cm

CC-3018-27

Criss-Cross Vena Cava Vascular Clamp Handles Curved Jaw 60° Large

29 cm

CC-3019-29



DeBakey Semb Vascular Clamp



Description

DeBakey Semb Vascular Clamp Handles Curved Jaw Fully Curved

Length

27 cm

Code

CC-2640-27

DeBakey S-form Vascular Clamp

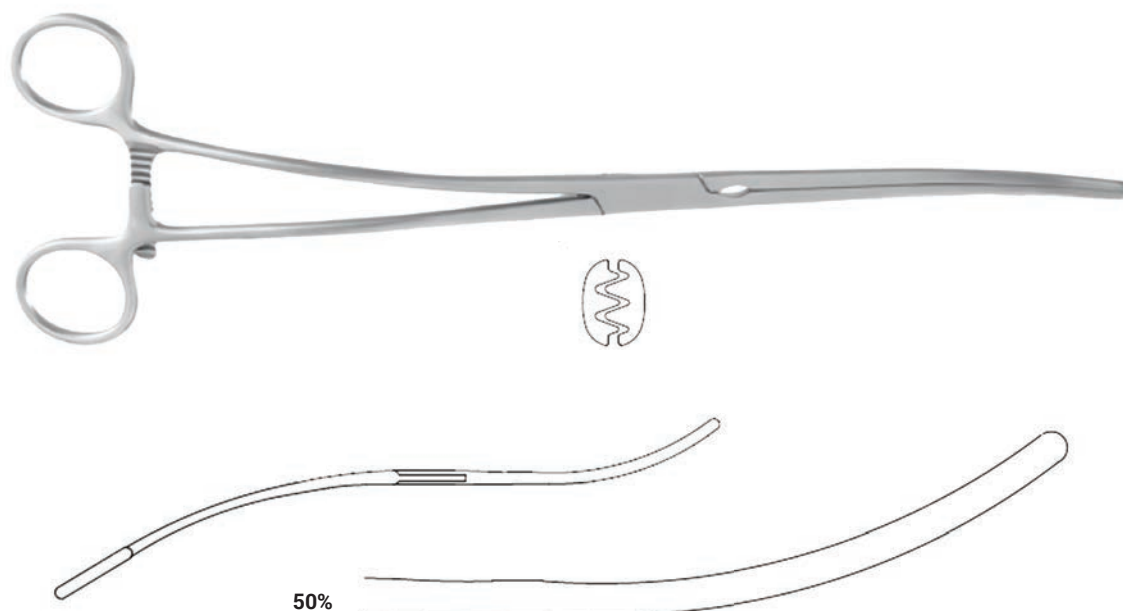

Description

DeBakey S-form Vascular Clamp Handles Curved Jaw Curved 115 mm

Length

30 cm

Code

CC-2600-30

MICRO VASCULAR CLAMPS

DeBakey S-form Vascular Clamp

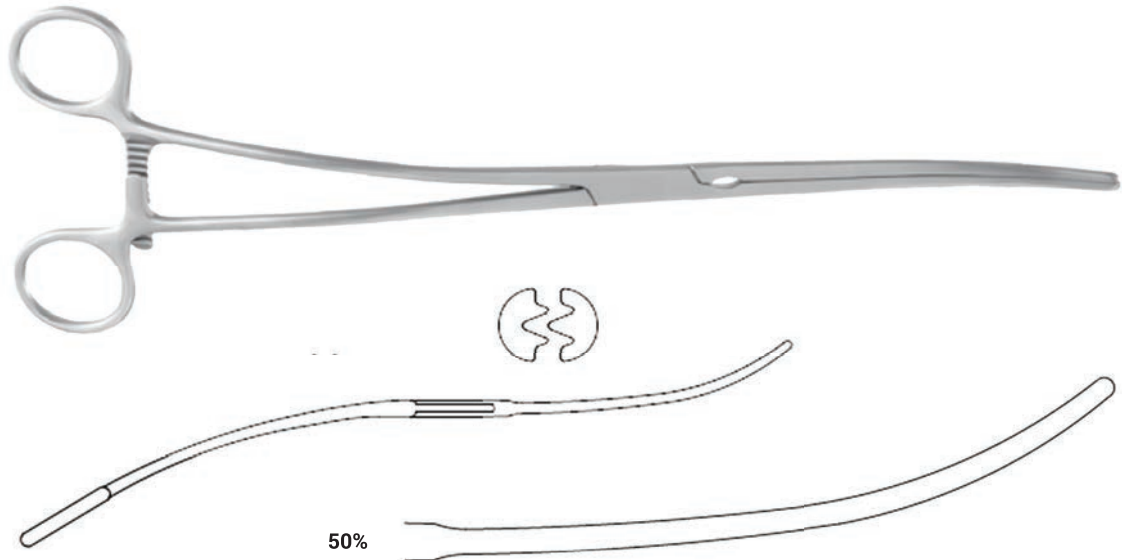

Description

DeBakey S-form Vascular Clamp Handles Curved Jaw Curved 115 mm
 DeBakey S-form Vascular Clamp Handles Curved Jaw Curved 115 mm

Length

30 cm
 33 cm

Code

CC-2609-30
 CC-2610-33

DeBakey C-form Vascular Clamp

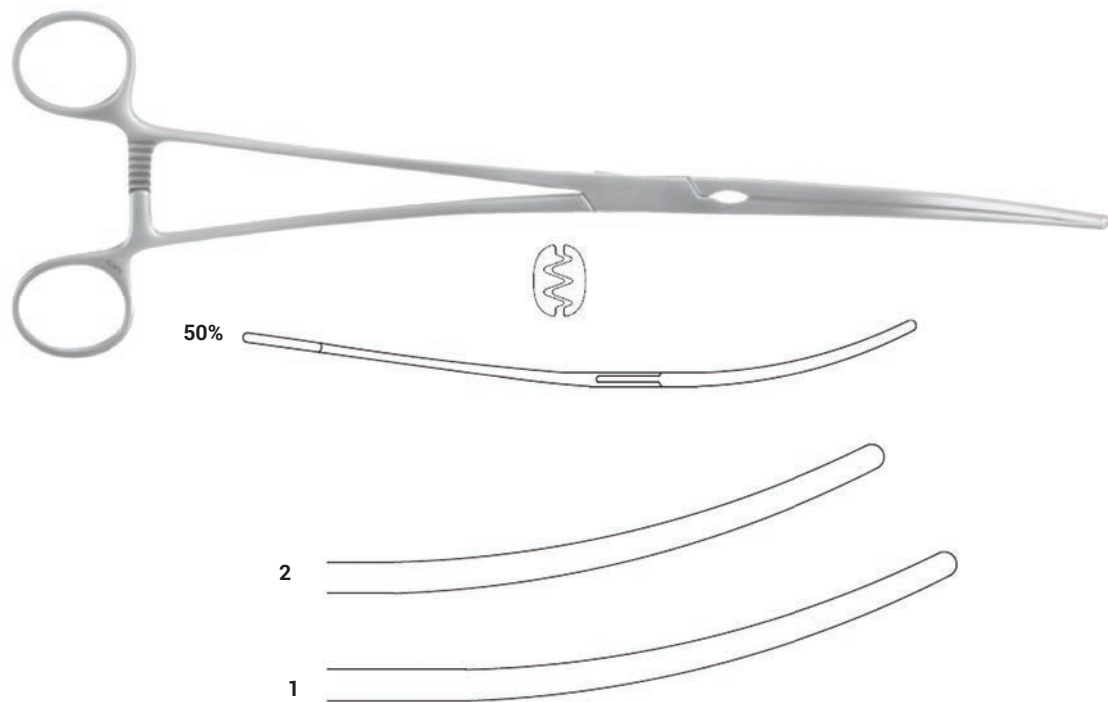

Description

DeBakey C-form Vascular Clamp Handles Curved Jaw Curved
 DeBakey C-form Vascular Clamp Handles Curved Jaw Curved

Length

32 cm
 33 cm

Code

CC-2605-32
 CC-2607-33

Favaloro Vascular Clamp

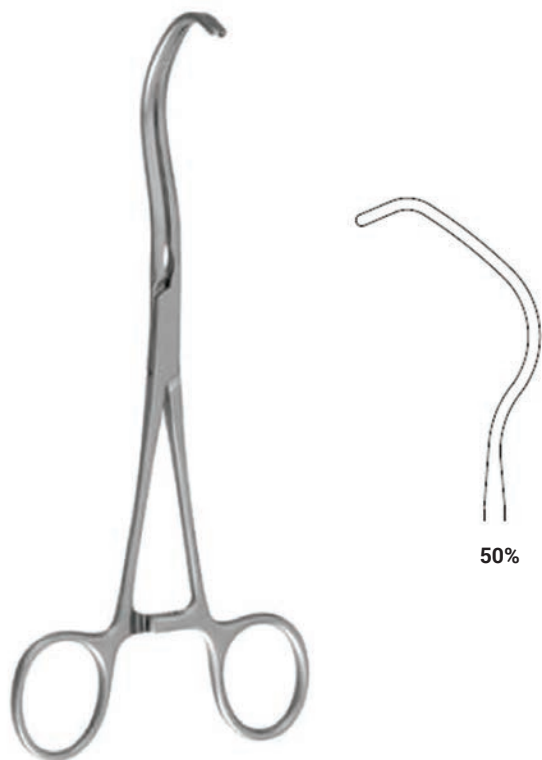

Description

Favaloro Vascular Clamp Handles Straight Jaw Satinsky 45 mm

Length

19 cm

Code

CC-2588-19

Lambert-Kay Vascular Clamp

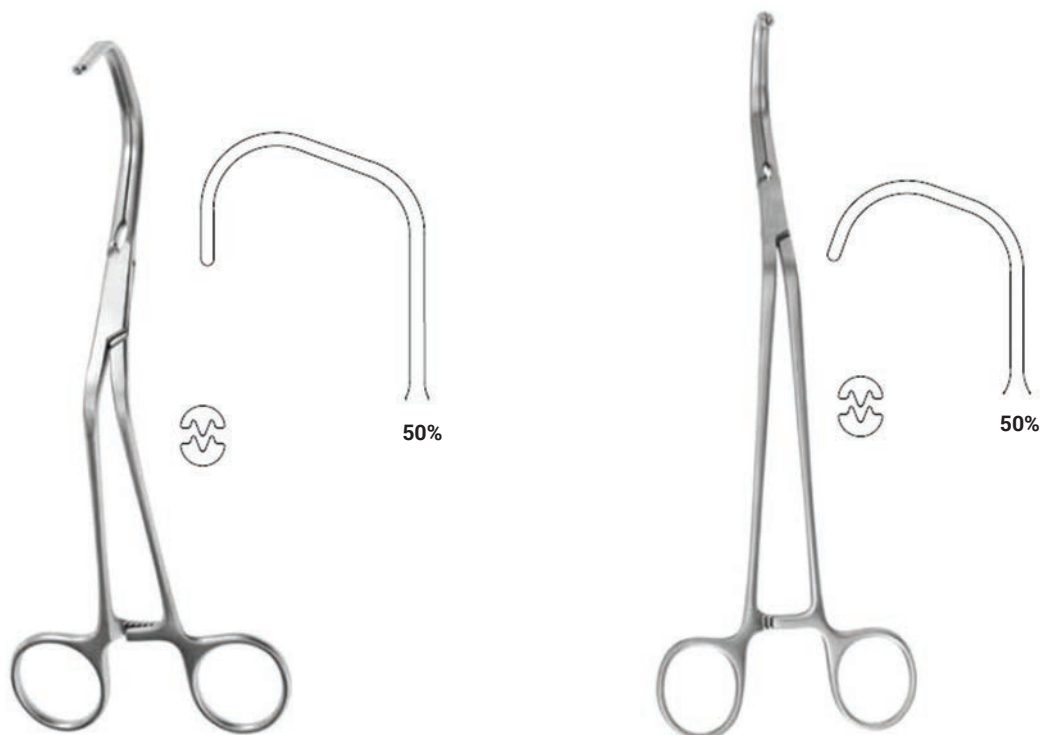

Description

- Lambert-Kay Vascular Clamp Handles Angled Jaw 35 mm
- Lambert-Kay Vascular Clamp Handles Angled Jaw 25 mm
- Lambert-Kay Vascular Clamp Handles Angled Jaw 25 mm

Length

- 16 cm
- 16 cm
- 20 cm

Code

- CC-2580-16
- CC-2585-16
- CC-2584-20

MICRO VASCULAR CLAMPS

Parsonnet Vascular
Clamp**Description**

Parsonnet Vascular Clamp Handles Curved Jaw 24 mm
 Parsonnet Vascular Clamp Handles Curved Jaw 28 mm
 Parsonnet Vascular Clamp Handles Curved Jaw 32 mm
 Parsonnet Vascular Clamp Handles Curved Jaw 38 mm
 Parsonnet Vascular Clamp Handles Curved Jaw 45 mm

Length

23 cm
 24 cm
 24 cm
 24 cm
 25 cm

Code

CC-2589-23
 CC-2590-24
 CC-2591-24
 CC-2592-24
 CC-2593-25

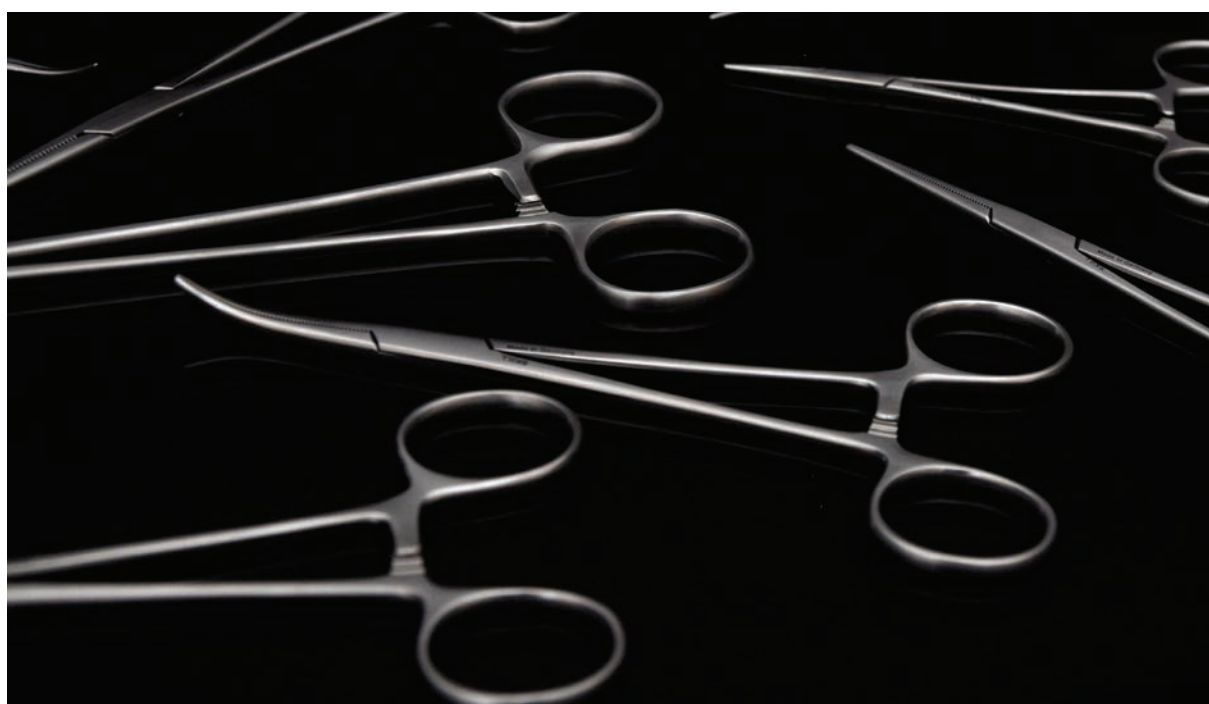

Strong Aorta Vascular Clamp

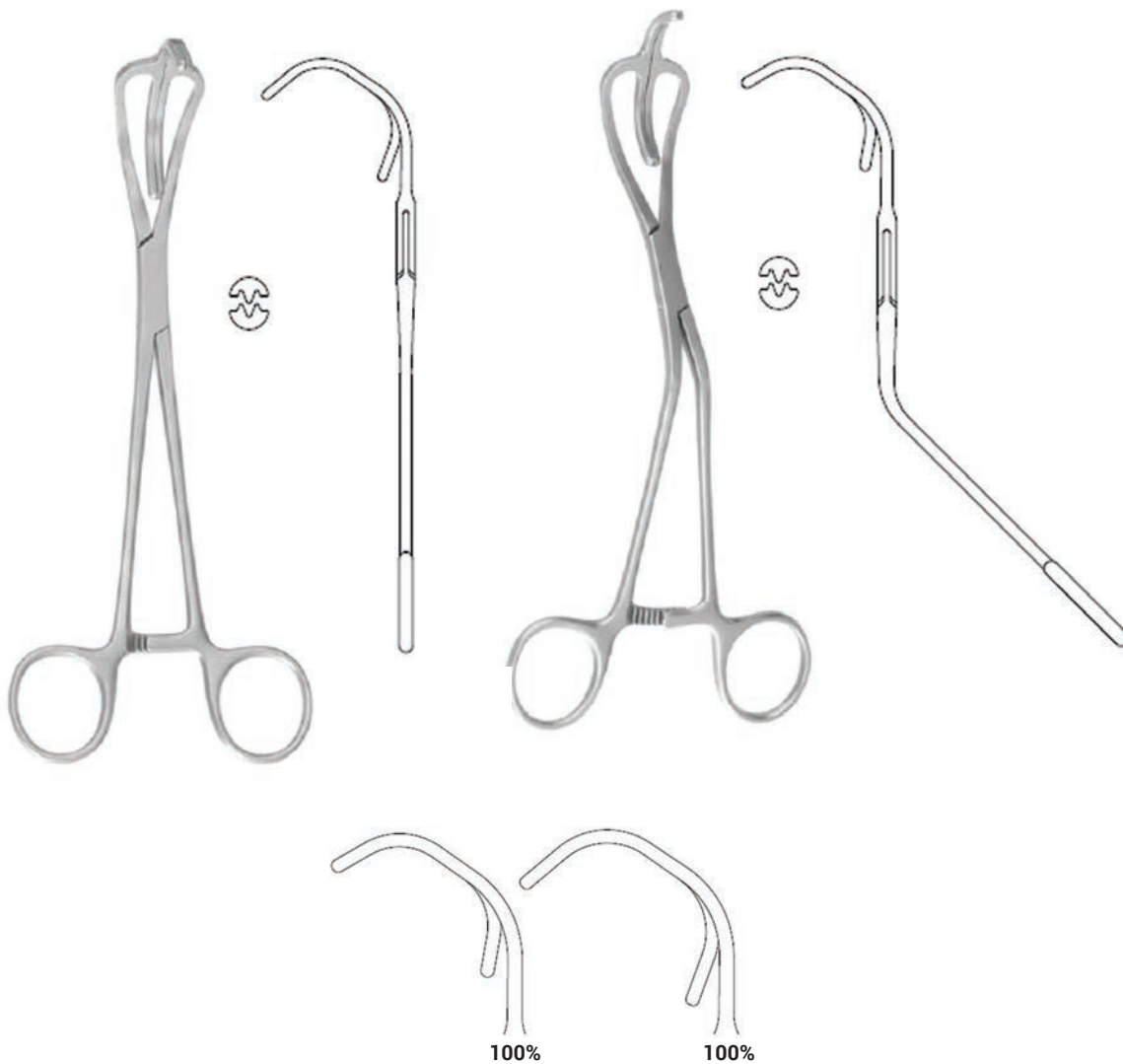

Description

Strong Aorta Vascular Clamp Handles Angled Jaw 41 mm
 Strong Aorta Vascular Clamp Handles Angled Jaw 45 mm
 Strong Aorta Vascular Clamp Handles Straight Jaw 41 mm
 Strong Aorta Vascular Clamp Handles Straight Jaw 45 mm

Length

18 cm
 18 cm
 20 cm
 20 cm

Code

CC-2483-18
 CC-2484-18
 CC-2481-20
 CC-2482-20



MICRO VASCULAR CLAMPS

Fogerty Insert Clamp

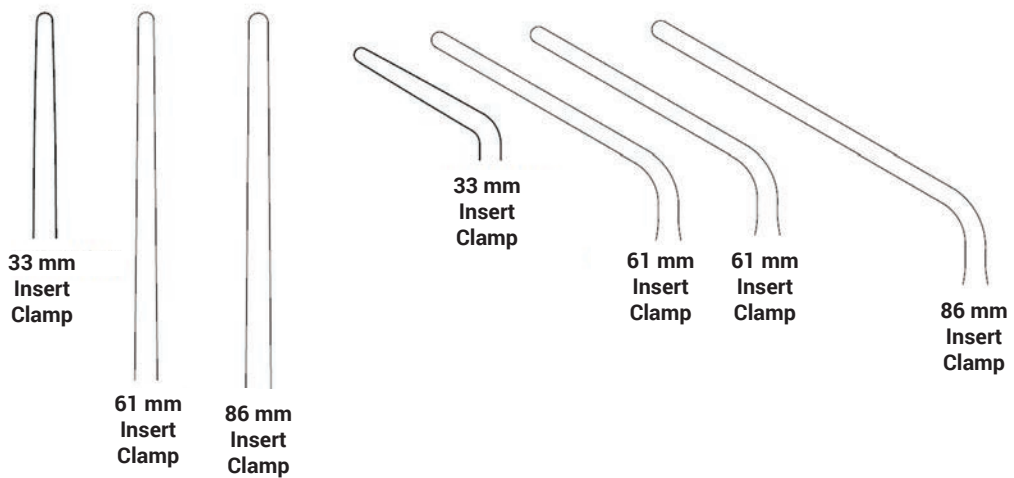

Description	Length	Code
Fogerty Insert Clamp Handles Curved Jaw 60° 33 mm Insert	14 cm	CC-90025-14
Fogerty Insert Clamp Handles Curved Jaw Straight 33 mm Insert	17 cm	CC-90020-17
Fogerty Insert Clamp Handles Curved Jaw 60° 61 mm Insert	25 cm	CC-90040-25
Fogerty Insert Clamp Handles Curved Jaw 60° 61 mm Insert	25 cm	CC-90045-25
Fogerty Insert Clamp Handles Curved Jaw 60° 86 mm Insert	25 cm	CC-90050-25
Fogerty Insert Clamp Handles Curved Jaw Straight 61 mm Insert	30 cm	CC-90030-30
Fogerty Insert Clamp Handles Curved Jaw Straight 86 mm Insert	30 cm	CC-90055-30

Leland-Jones Vascular Clamp

Description	Length	Code
Leland-Jones Vascular Clamp Handles Straight Jaw Straight 45°	18 cm	CC-2489-18
Leland-Jones Vascular Clamp Handles Straight Jaw Straight 30°	19 cm	CC-2492-19
Leland-Jones Vascular Clamp Handles Straight Jaw Straight	20 cm	CC-2490-20
Leland-Jones Vascular Clamp Handles Straight Jaw Straight 15°	20 cm	CC-2491-20

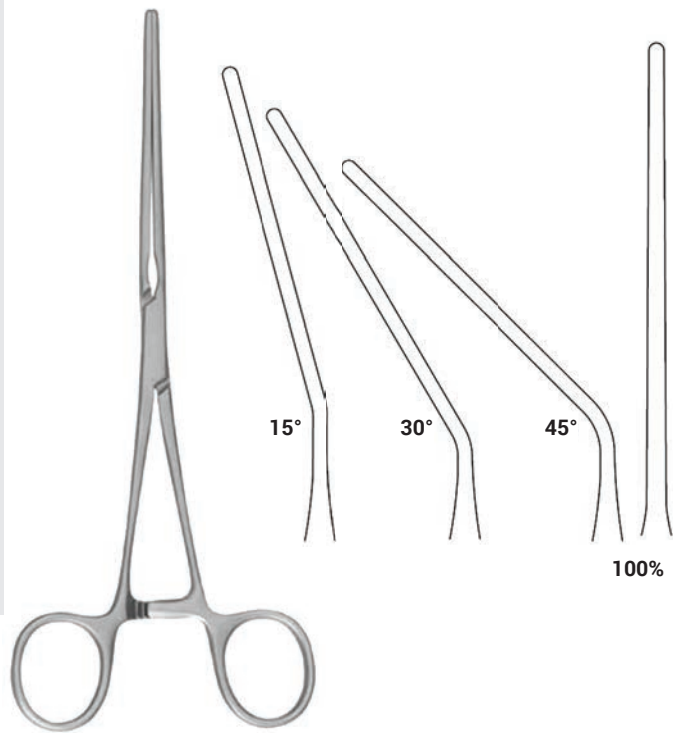

Wylie Clamp

Description	Length	Code
Wylie Clamp Handles Curved Jaw Strongly Curved	22 cm	CC-2654-22



Wylie J-type Clamp

Description	Length	Code
Wylie J-type Clamp Handles Curved Jaw Curved	23 cm	CC-2656-23



Wylie Aorta Clamp

Description	Length	Code
Wylie Aorta Clamp Handles Angled Jaw Slightly Curved	21 cm	CC-2657-21
Wylie Aorta Clamp Handles Angled Jaw Slightly Curved	24 cm	CC-2658-24



Wylie Aorta Clamp

Description	Length	Code
Wylie Aorta Clamp Handles Angled Jaw Slightly Curved	23 cm	CC-3280-23

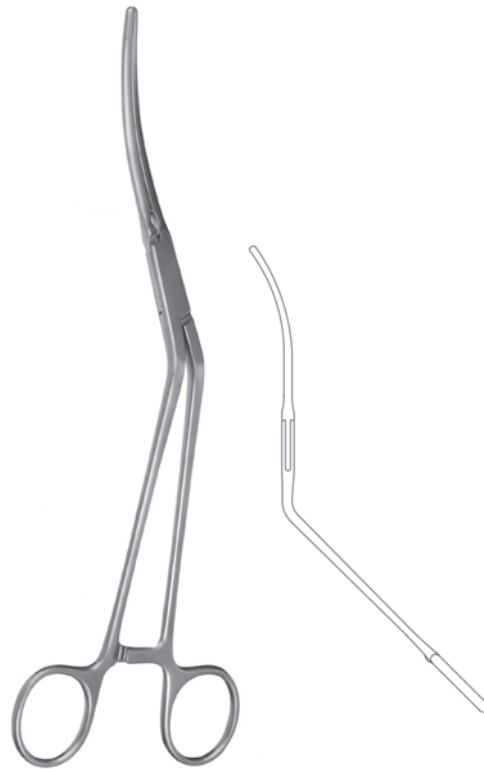

Wylie External Clamp

Description	Length	Code
Wylie External Clamp Handles Straight Jaw Double Angled	23 cm	CC-2570-23

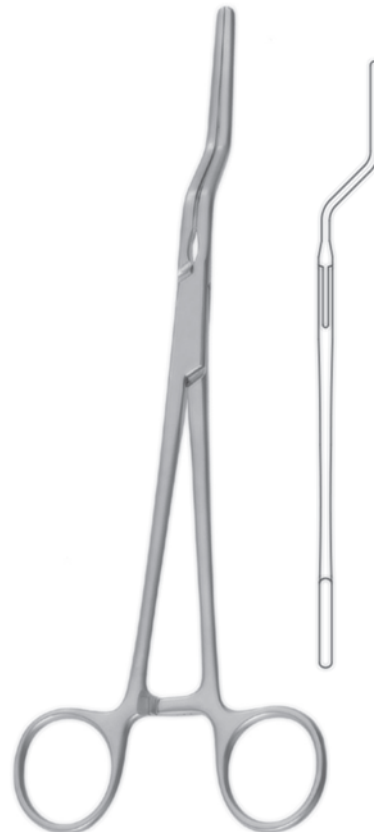

Wylie Internal Clamp

Description	Length	Code
Wylie Internal Clamp Handles Angled	25 cm	CC-2571-25



Wylie Vascular Clamp

Description	Length	Code
Wylie Vascular Clamp Handles Curved, Up, Jaw Curved	16 cm	CC-3277-16
Wylie Vascular Clamp Handles Curved, Up, Jaw Curved	18 cm	CC-3276-18



Wylie Vascular Clamp

Description

Wylie Vascular Clamp
Handles Curved, Down,
Jaw Curved

Length

16 cm

Code

CC-3279-16

Wylie Vascular Clamp
Handles Curved, Down,
Jaw Curved

18 cm

CC-3278-18



Liver Clamp

Description

1. Liver Clamp,
Handles Straight,
Potts Teeth

Length

25

CC-7496-25

2. Liver Clamp,
Handles Straight,
Potts Teeth

26

CC-7497-26

3. Liver Clamp,
Handles Straight,
Potts Teeth

27

CC-7498-27

4. Liver Clamp,
Handles Straight,
Potts Teeth

27

CC-7499-27

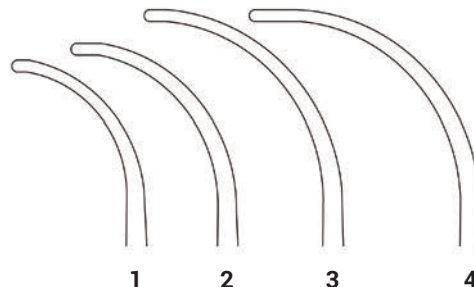

MICRO VASCULAR CLAMPS

Peaen Artery Forceps Straight

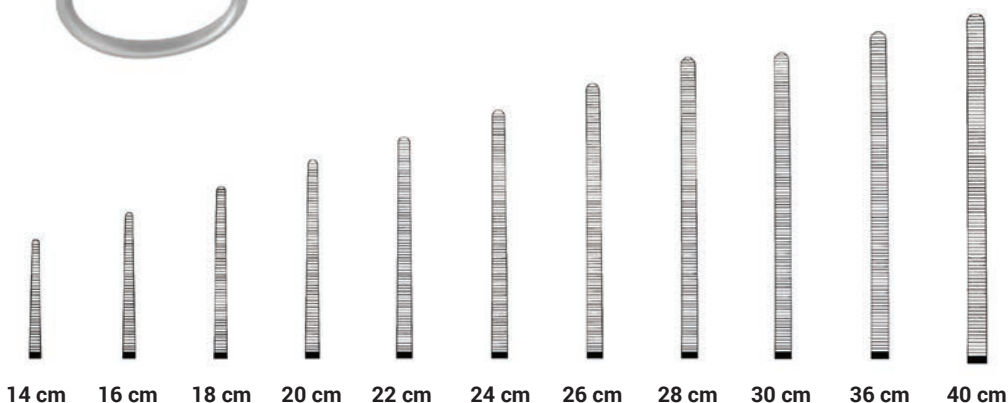

14 cm 16 cm 18 cm 20 cm 22 cm 24 cm 26 cm 28 cm 30 cm 36 cm 40 cm

Description

Length

Code

Peaen Artery Forceps Straight	14 cm	BF-000-14
Peaen Artery Forceps Straight	16 cm	BF-000-16
Peaen Artery Forceps Straight	18 cm	BF-000-18
Peaen Artery Forceps Straight	20 cm	BF-000-20
Peaen Artery Forceps Straight	22 cm	BF-000-22
Peaen Artery Forceps Straight	24 cm	BF-000-24
Peaen Artery Forceps Straight	26 cm	BF-000-26
Peaen Artery Forceps Straight	28 cm	BF-000-28
Peaen Artery Forceps Straight	30 cm	BF-000-30
Peaen Artery Forceps Straight	36 cm	BF-000-36
Peaen Artery Forceps Straight	40 cm	BF-000-40



Peaen Artery Forceps Curved

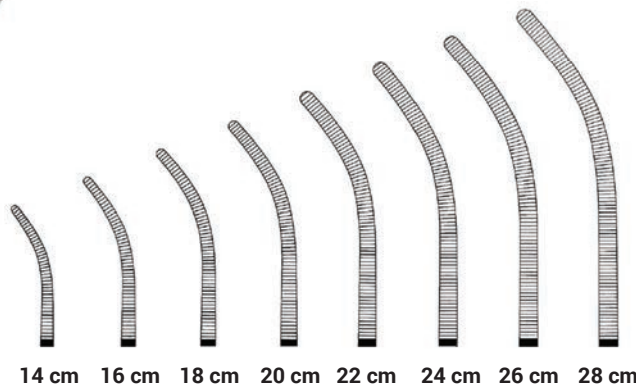

Description

Peaen Artery Forceps Curved
 Peaen Artery Forceps Curved
 Peaen Artery Forceps Curved
 Peaen Artery Forceps Curved
 Peaen Artery Forceps Curved
 Peaen Artery Forceps Curved
 Peaen Artery Forceps Curved
 Peaen Artery Forceps Curved

Length

14 cm
 16 cm
 18 cm
 20 cm
 22 cm
 24 cm
 26 cm
 28 cm

Code

BF-001-14
 BF-001-16
 BF-001-18
 BF-001-20
 BF-001-22
 BF-001-24
 BF-001-26
 BF-001-28



Spencer-Wells Artery Forceps Straight

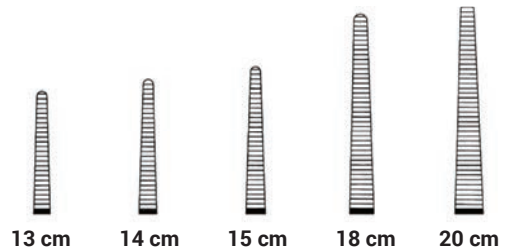

Description

Spencer-Wells Artery Forceps Straight
 Spencer-Wells Artery Forceps Straight
 Spencer-Wells Artery Forceps Straight
 Spencer-Wells Artery Forceps Straight
 Spencer-Wells Artery Forceps Straight

Length

13 cm
 14 cm
 15 cm
 18 cm
 20 cm

Code

BF-002-13
 BF-002-14
 BF-002-15
 BF-002-18
 BF-002-20

Spencer-Wells Artery Forceps Curved

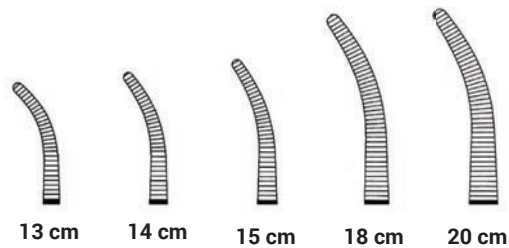

Description

Spencer-Wells Artery Forceps Curved
 Spencer-Wells Artery Forceps Curved
 Spencer-Wells Artery Forceps Curved
 Spencer-Wells Artery Forceps Curved
 Spencer-Wells Artery Forceps Curved

Length

13 cm
 14 cm
 15 cm
 18 cm
 20 cm

Code

BF-003-13
 BF-003-14
 BF-003-15
 BF-003-18
 BF-003-20

Heiss Artery Forceps



Description

Heiss Artery Forceps Straight
 Heiss Artery Forceps Curved
 Heiss Artery Forceps Fully Curved

Length

20 cm
 20 cm
 20 cm

Code

BF-022-20
 BF-023-20
 BF-025-20

Adson Artery Forceps

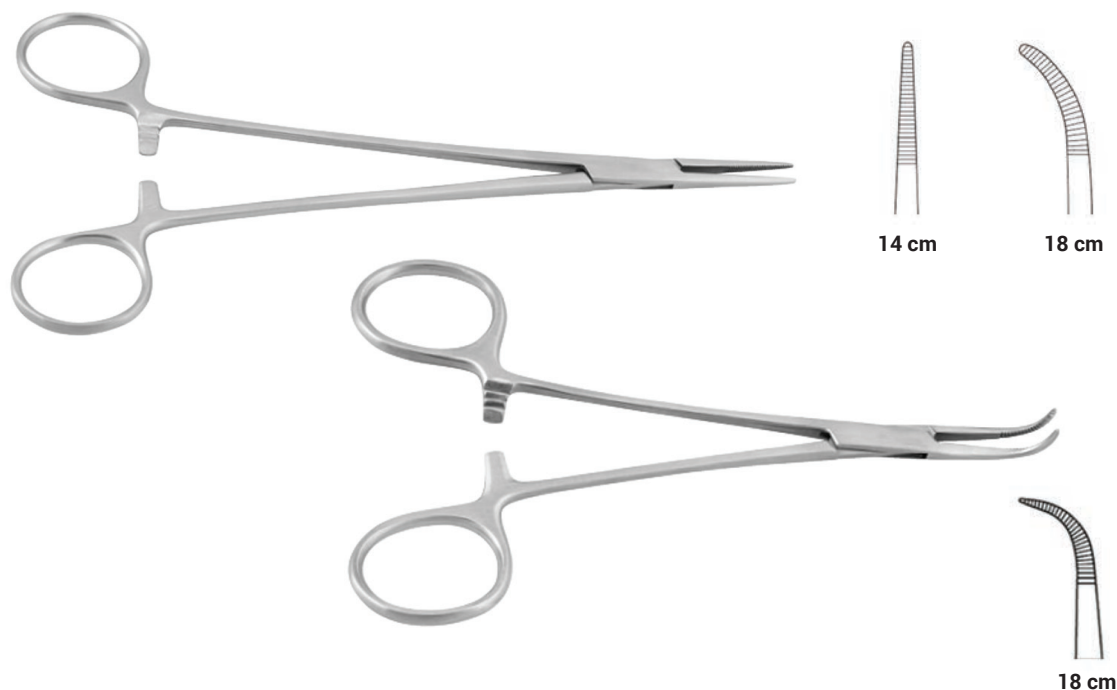

Description

Baby Adson Artery Forceps Curved
 Adson Artery Forceps Straight
 Adson Artery Forceps Curved

Length

14 cm
 18 cm
 18 cm

Code

BF-033-14
 BF-030-18
 BF-031-18

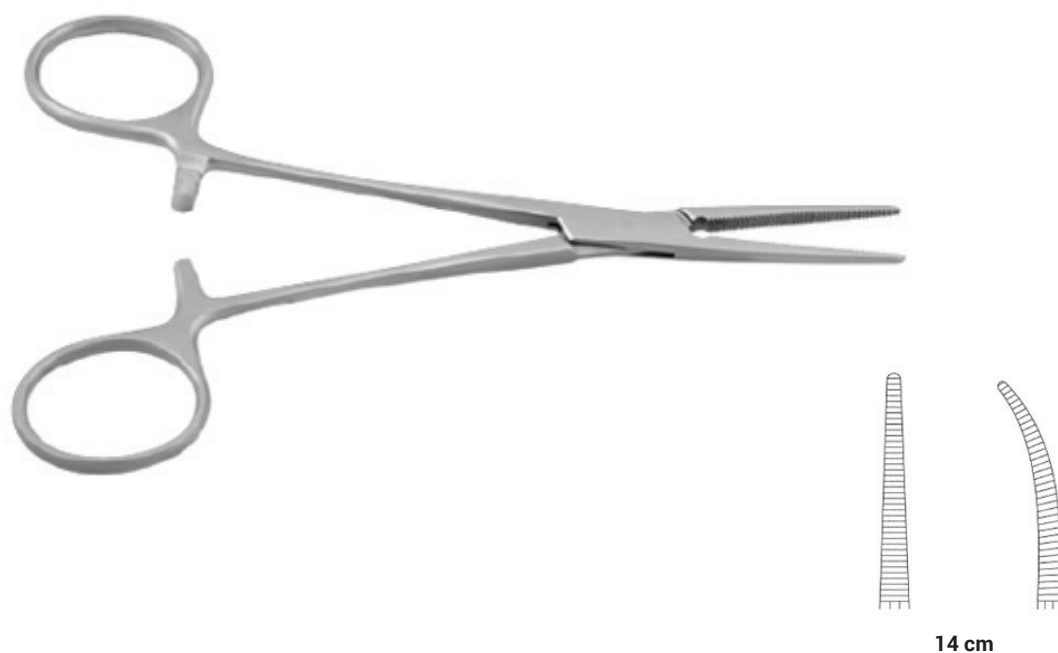
Crile Artery Forceps**Description**

Crile Artery Forceps Straight

Crile Artery Forceps Curved

Length

14 cm

14 cm

Code

BF-048-14

BF-049-14

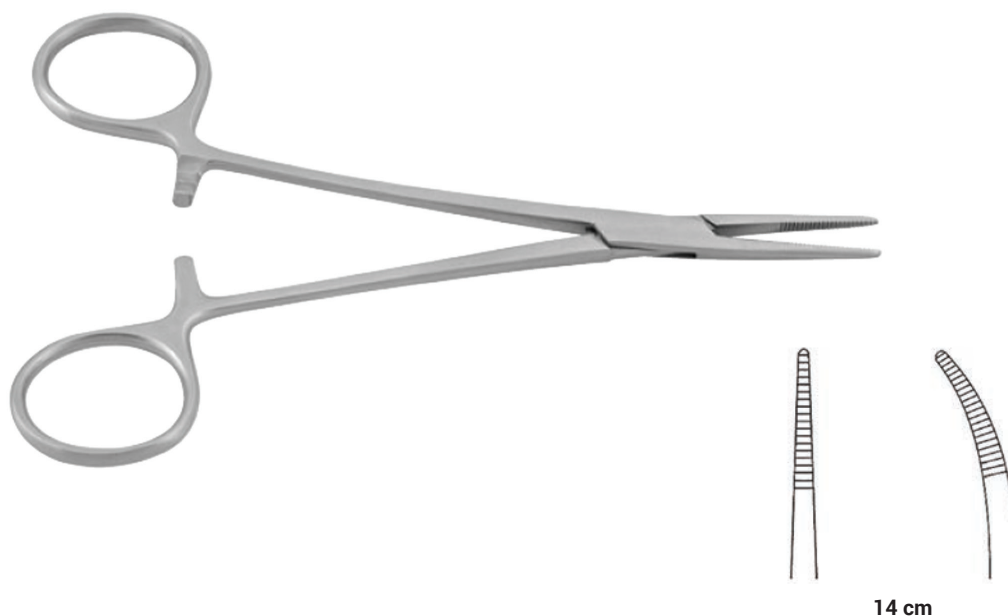
Kelly Artery Forceps**Description**

Kelly Artery Forceps Straight

Kelly Artery Forceps Curved

Length

14 cm

14 cm

Code

BF-033-14

BF-034-14

Birkett Artery Forceps



18 cm

Description

Birkett Artery Forceps Straight
Birkett Artery Forceps Curved

Length

18 cm
18 cm

Code

BF-056-18
BF-057-18

Halsted-Mosquito Artery Forceps

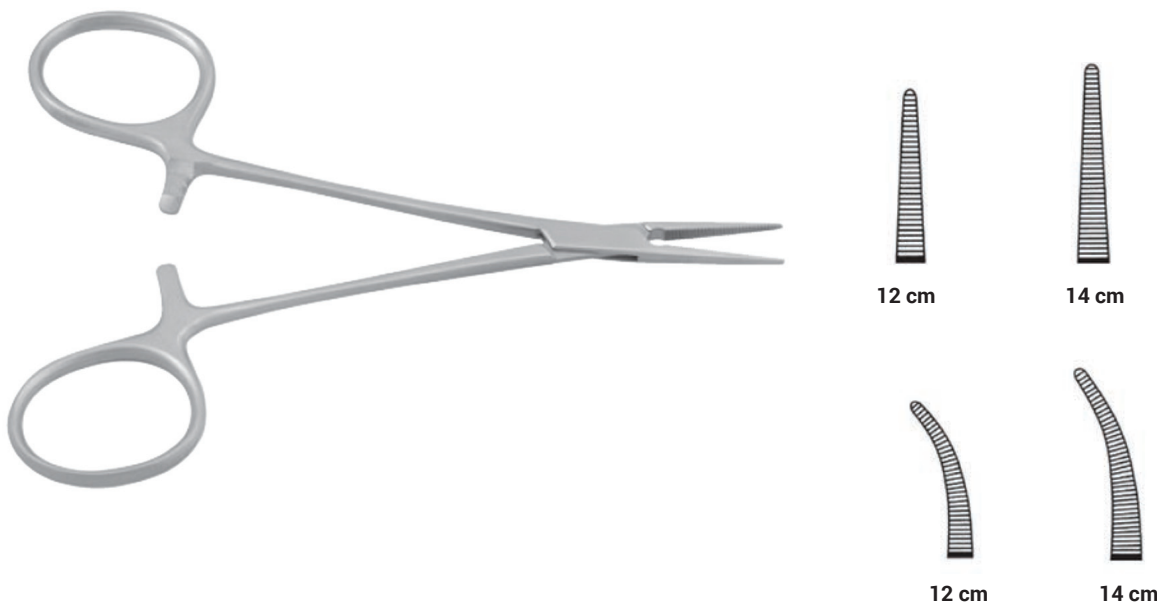

12 cm

14 cm

12 cm

14 cm

Description

Halsted-Mosquito Artery Forceps Straight
Halsted-Mosquito Artery Forceps Curved
Halsted-Mosquito Artery Forceps Straight
Halsted-Mosquito Artery Forceps Curved

Length

12 cm
12 cm
14 cm
14 cm

Code

BF-060-12
BF-061-12
BF-060-14
BF-061-14

MICRO VASCULAR CLAMPS

Micro-Mosquito Artery Forceps

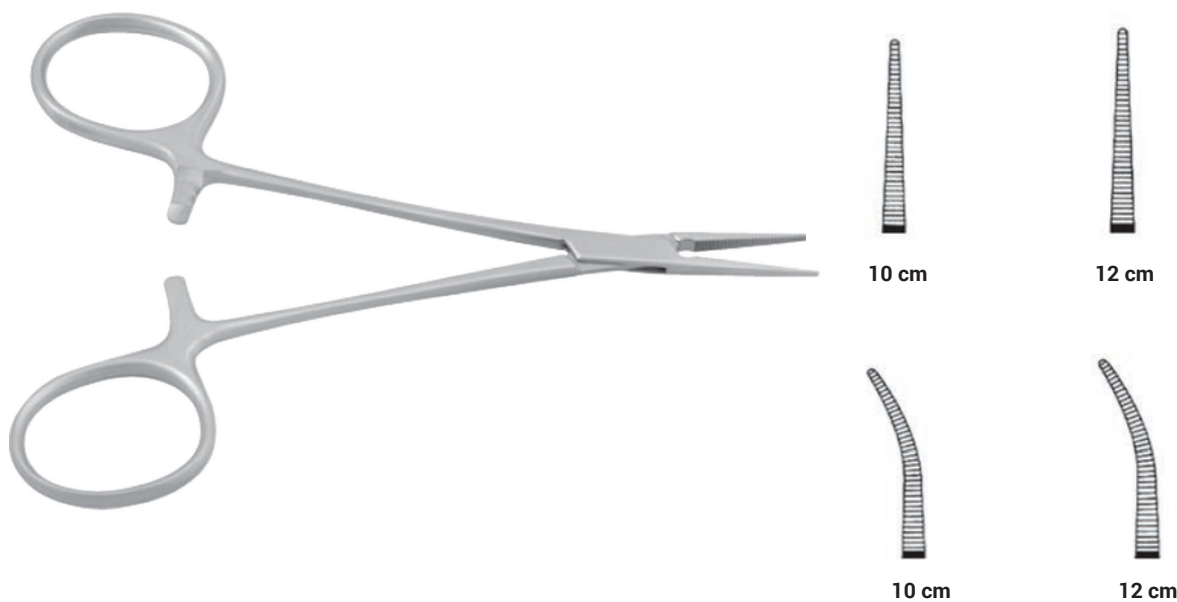

Description	Length	Code
Micro-Mosquito Artery Forceps Straight	10 cm	BF-062-10
Micro-Mosquito Artery Forceps Curved	10 cm	BF-063-10
Micro-Mosquito Artery Forceps Straight	12 cm	BF-062-12
Micro-Mosquito Artery Forceps Curved	12 cm	BF-063-12



Kocher Artery Forceps Straight

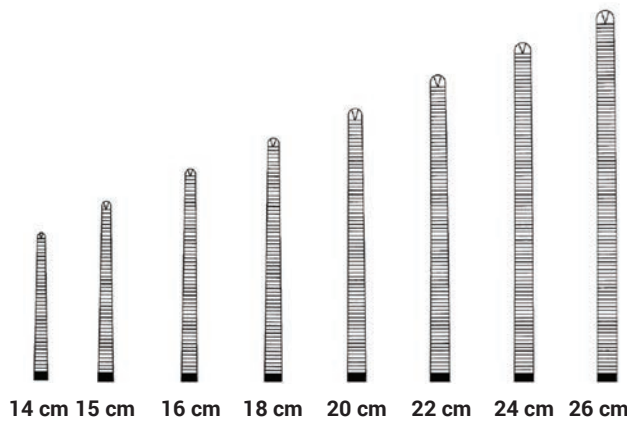

Description

Kocher Artery Forceps Straight
 Kocher Artery Forceps Straight
 Kocher Artery Forceps Straight
 Kocher Artery Forceps Straight
 Kocher Artery Forceps Straight
 Kocher Artery Forceps Straight
 Kocher Artery Forceps Straight
 Kocher Artery Forceps Straight

Length

14 cm
 15 cm
 16 cm
 18 cm
 20 cm
 22 cm
 24 cm
 26 cm

Code

BF-100-14
 BF-100-15
 BF-100-16
 BF-100-18
 BF-100-20
 BF-100-22
 BF-100-24
 BF-100-26

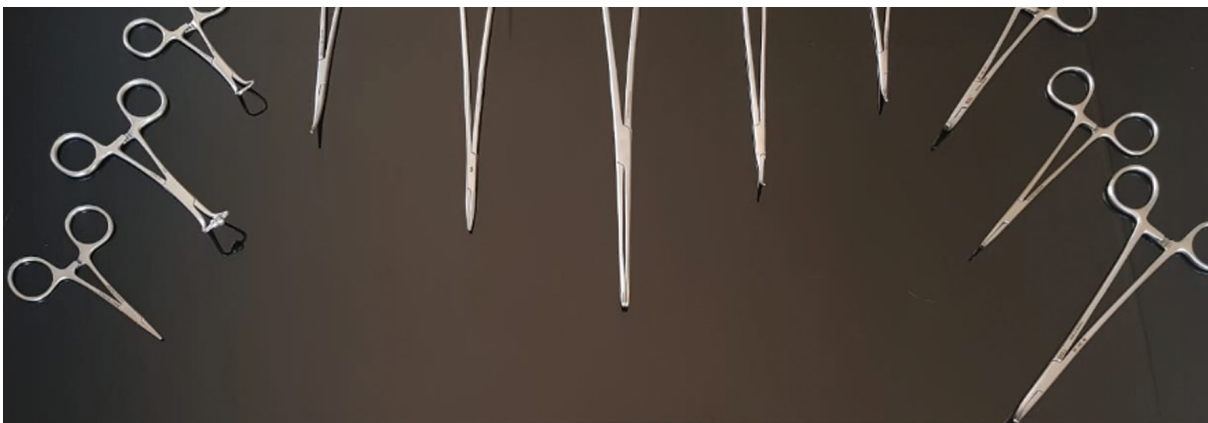

MICRO VASCULAR CLAMPS

Kocher Artery Forceps Curved

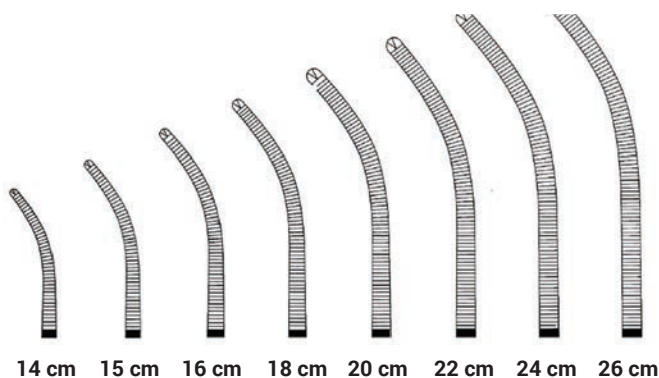

14 cm 15 cm 16 cm 18 cm 20 cm 22 cm 24 cm 26 cm

Description	Length	Code
Kocher Artery Forceps Curved	14 cm	BF-101-14
Kocher Artery Forceps Curved	15 cm	BF-101-15
Kocher Artery Forceps Curved	16 cm	BF-101-16
Kocher Artery Forceps Curved	18 cm	BF-101-18
Kocher Artery Forceps Curved	20 cm	BF-101-20
Kocher Artery Forceps Curved	22 cm	BF-101-22
Kocher Artery Forceps Curved	24 cm	BF-101-24
Kocher Artery Forceps Curved	26 cm	BF-101-26



Gemini Artery Forceps Curved

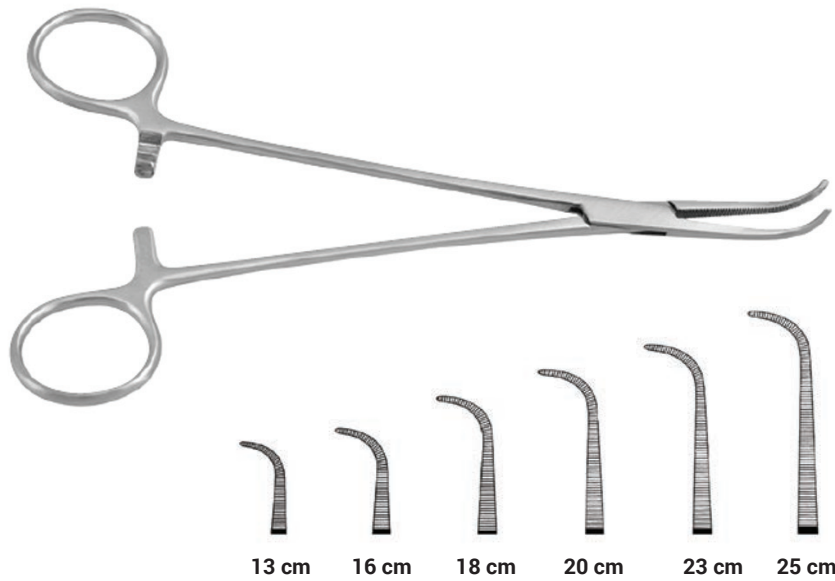

Description

Gemini Artery Forceps Curved
 Gemini Artery Forceps Curved
 Gemini Artery Forceps Curved
 Gemini Artery Forceps Curved
 Gemini Artery Forceps Curved
 Gemini Artery Forceps Curved

Length

13 cm
 16 cm
 18 cm
 20 cm
 23 cm
 25 cm

Code

BF-237-13
 BF-237-16
 BF-237-18
 BF-237-20
 BF-237-23
 BF-237-25

Crafoord Artery Forceps Curved

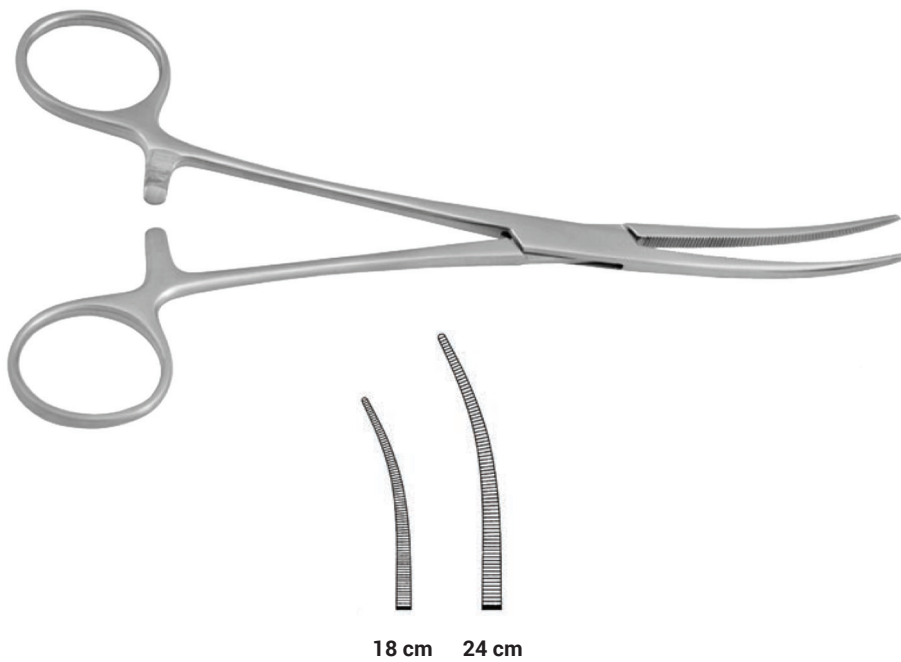

Description

Crafoord Artery Forceps Curved
 Crafoord Artery Forceps Curved

Length

18 cm
 24 cm

Code

BF-245-18
 BF-245-24

Roberts Artery Forceps

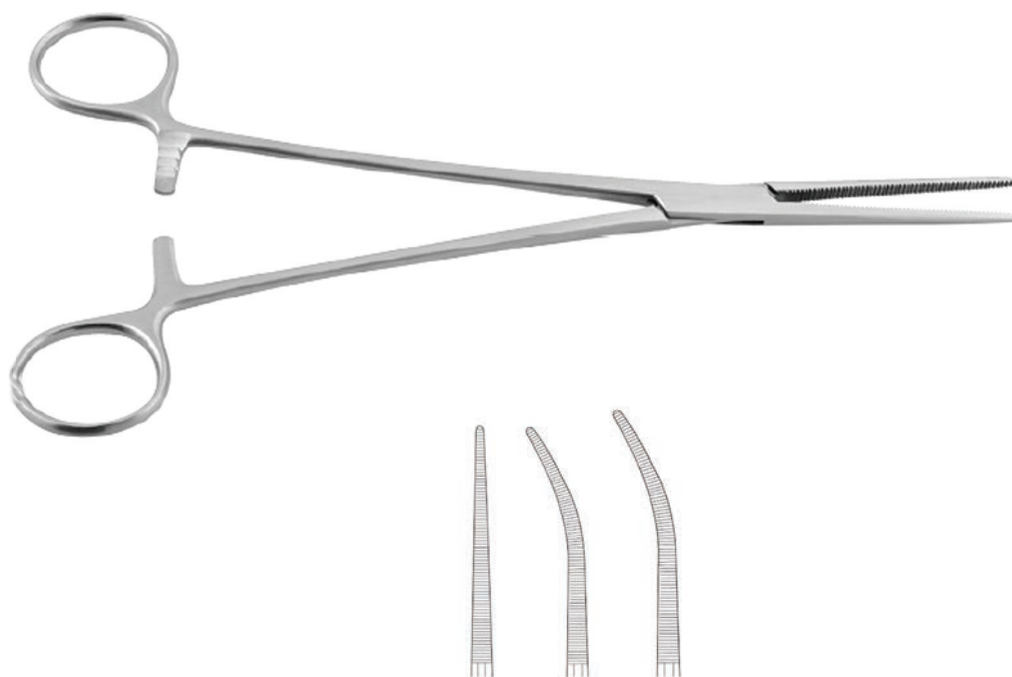

22 cm

Description

Roberts Artery Forceps Straight
 Roberts Artery Forceps Curved
 Roberts Artery Forceps Curved

Length

22 cm
 22 cm
 25 cm

Code

BF-266-22
 BF-267-22
 BF-267-25

Bailey Fine Forceps



Description

Bailey Fine Forceps 30° Angle Jaw
 Bailey Fine Forceps 60° Angle Jaw
 Bailey Fine Forceps 90° Angle Jaw

Length

18 cm
 18 cm
 18 cm

Code

BF-411-30
 BF-411-60
 BF-411-90

Mixer Artery Forceps Curved

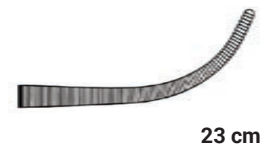
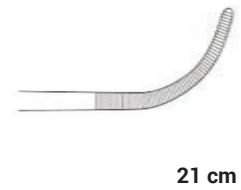
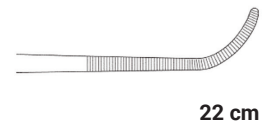

Description

Overholt-Mixer Artery Forceps Curved
 Mixer Artery Forceps Curved
 Mixer Artery Forceps Curved

Length

21 cm
 22 cm
 23 cm

Code

BF-261-21
 BF-259-22
 BF-259-23

MICRO VASCULAR CLAMPS

Mixer Artery Forceps Curved



Description

Mixer Artery Forceps Curved
 Mixer Artery Forceps Curved
 Mixer Artery Forceps Curved
 Mixer Artery Forceps Curved

Length

14 cm
 15 cm
 19 cm
 23 cm

Code

BF-263-14
 BF-263-15
 BF-263-19
 BF-263-23

Lahey Artery Forceps

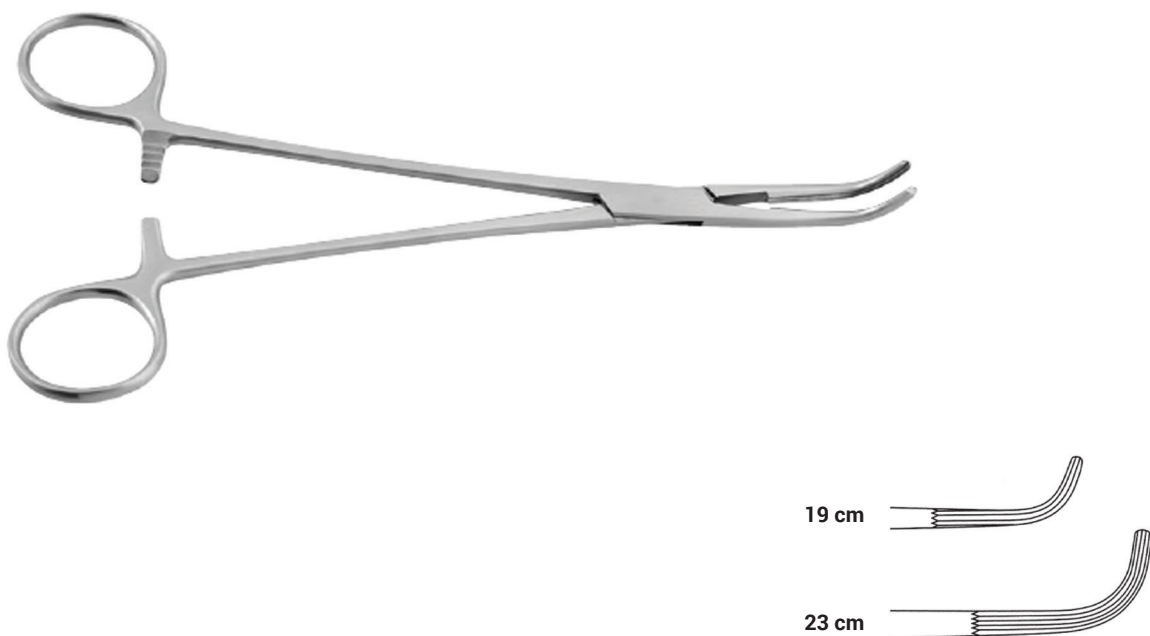

Description

Lahey Artery Forceps Curved
 Lahey Artery Forceps Curved

Length

19 cm
 23 cm

Code

BF-361-19
 BF-361-23

Rampléy Sponge Holding Forceps

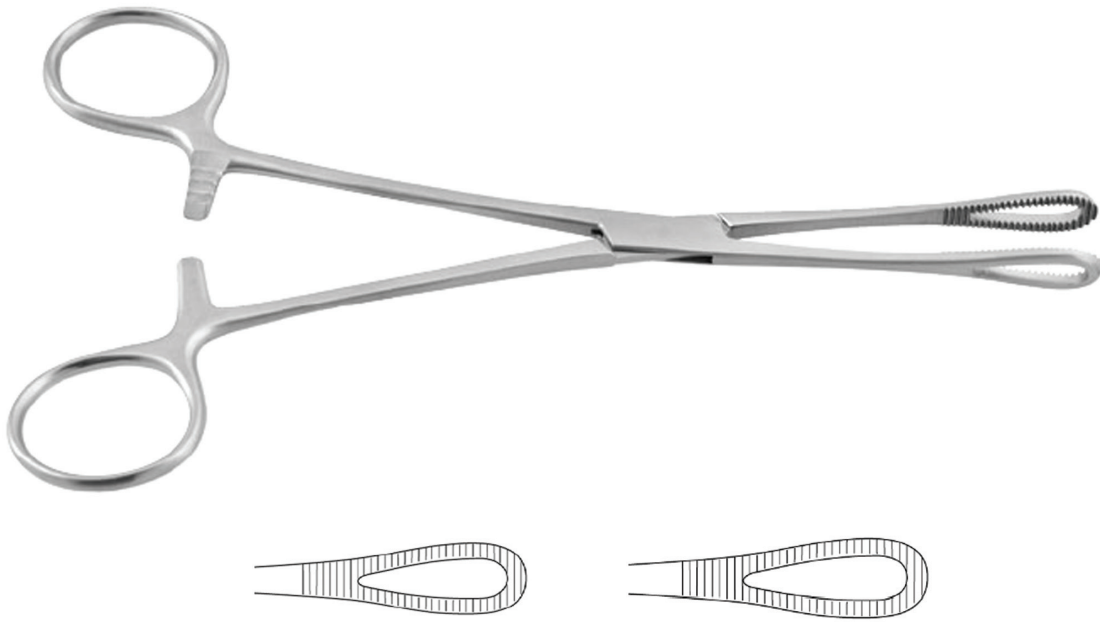

Description	Length	Code
Rampléy Sponge Holding Forceps	18 cm	BF-742-18
Rampléy Sponge Holding Forceps	25 cm	BF-742-25

Duval Grasping Forceps

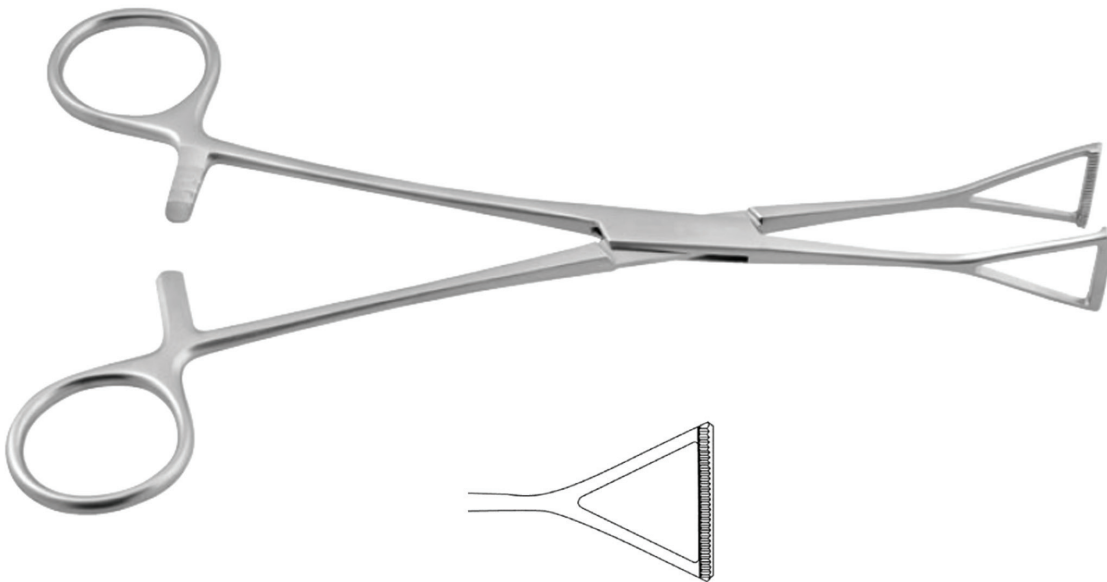

Description	Length	Code
Duval Grasping Forceps	18 cm	BF-752-18
Duval Grasping Forceps	20 cm	BF-752-20
Duval Grasping Forceps	23 cm	BF-752-23

Duval DeBakey Grasping Forceps

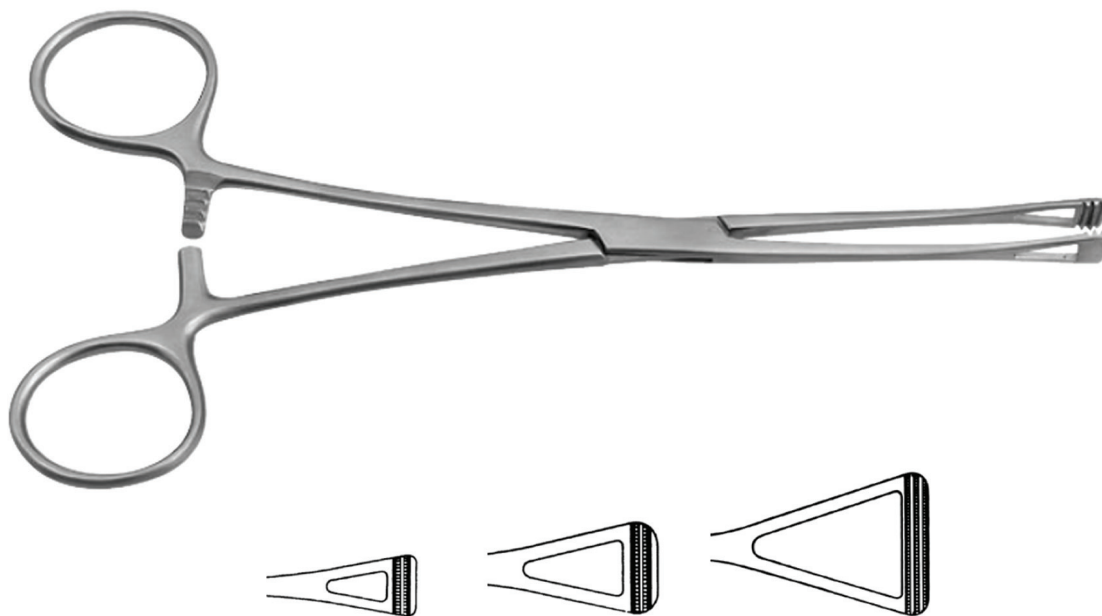

Description	Length	Code
Duval DeBakey Grasping Forceps	18 cm	BF-755-18
Duval DeBakey Grasping Forceps	20 cm	BF-755-20
Duval DeBakey Grasping Forceps	23 cm	BF-755-23

Babcock Grasping Forceps

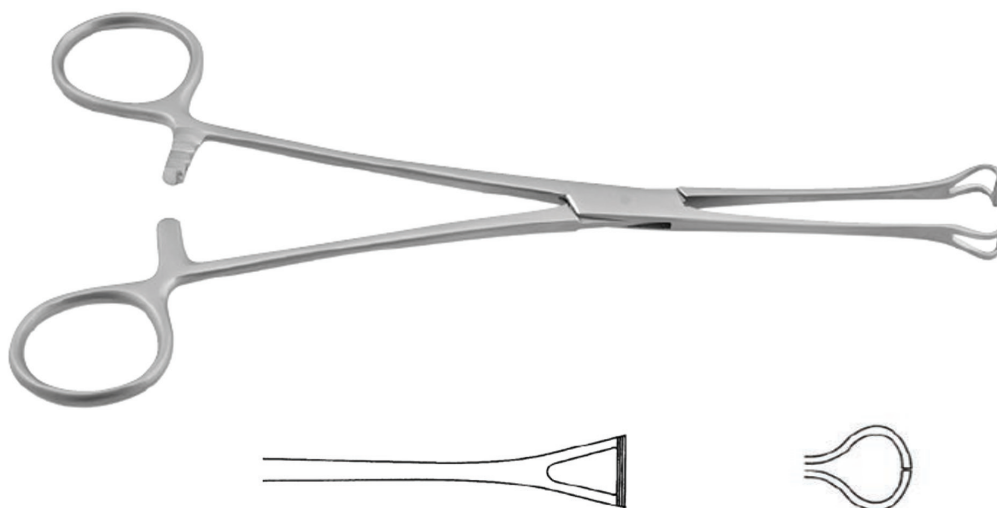

Description	Length	Code
Babcock Grasping Forceps	16 cm	BF-760-16
Babcock Grasping Forceps	18 cm	BF-760-18
Babcock Grasping Forceps	20 cm	BF-760-20
Babcock Grasping Forceps	24 cm	BF-760-24
Babcock Grasping Forceps	36 cm	BF-760-36

Allis Grasping Forceps

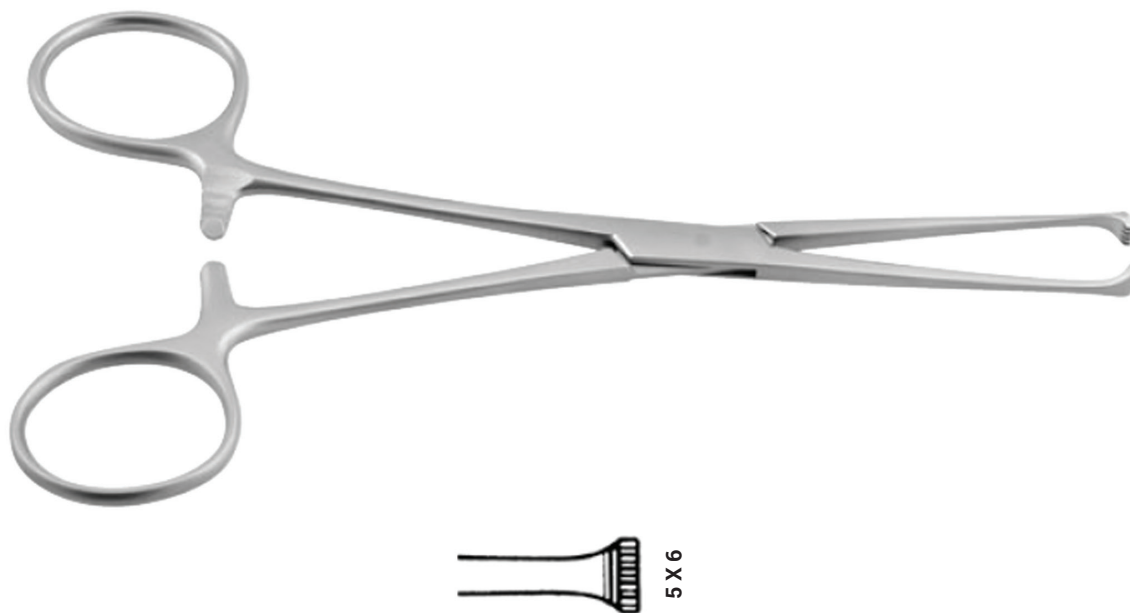

Description

Allis Grasping Forceps
 Allis Grasping Forceps
 Allis Grasping Forceps
 Allis Grasping Forceps

Length

15 cm
 19 cm
 22 cm
 25 cm

Code

BF-766-15
 BF-766-19
 BF-766-22
 BF-766-25

Littlewood Grasping Forceps

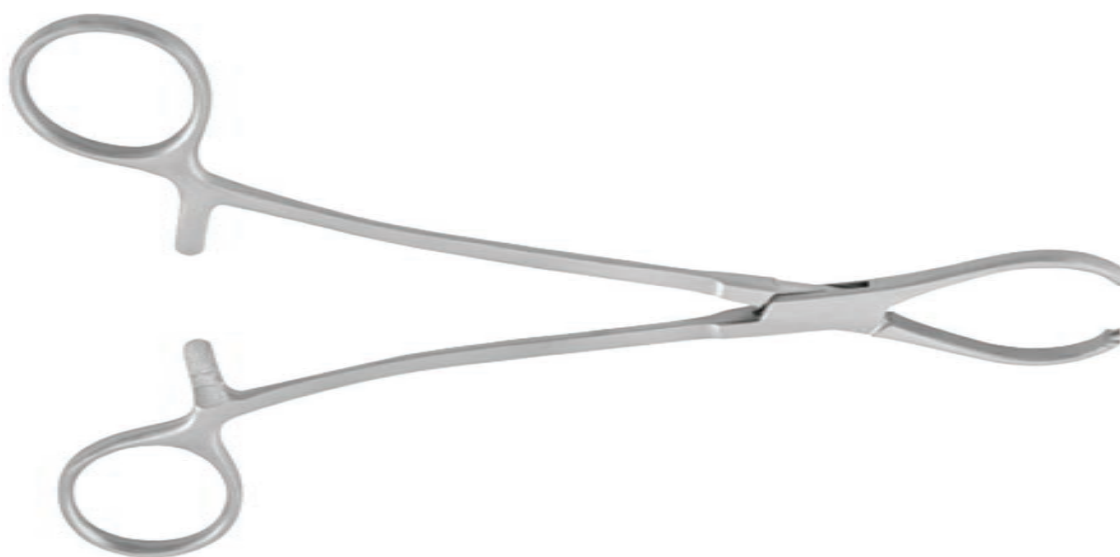

Description

Littlewood Grasping Forceps

Length

19 cm

Code

BF-773-19

Backhaus Towel Forceps**Description**

Backhaus Towel Forceps
 Backhaus Towel Forceps
 Backhaus Towel Forceps
 Backhaus Towel Forceps

Length

8 cm
 11 cm
 13 cm
 16 cm

Code

BF-801-08
 BF-801-11
 BF-801-13
 BF-801-16

Ball & Socket Towel Forceps**Description**

Ball & Socket Towel Forceps
 Ball & Socket Towel Forceps

Length

11 cm
 14 cm

Code

BF-805-11
 BF-805-14

Lane Towel Forceps**Description**

Lane Towel Forceps
 Lane Towel Forceps
 Lane Towel Forceps

Length

13 cm
 15 cm
 20 cm

Code

BF-811-13
 BF-811-15
 BF-811-20

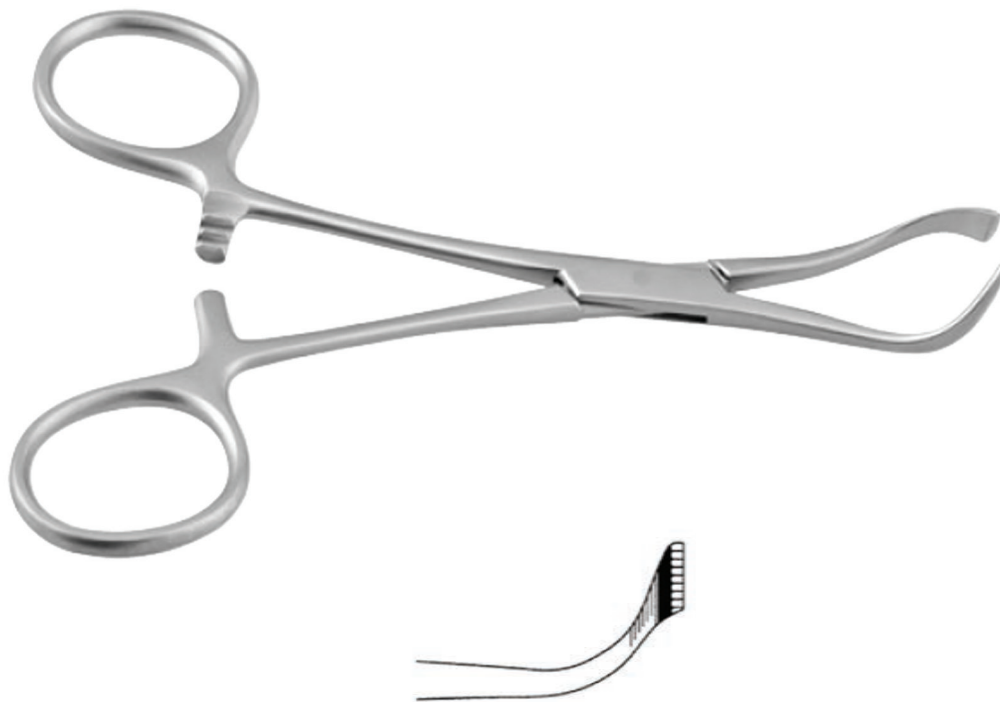
Lorna Towel Forceps**Description**

Lorna Towel Forceps
 Lorna Towel Forceps

Length

10 cm
 13 cm

Code

BF-806-10
 BF-806-13

Tubing Clamp Forceps Straight

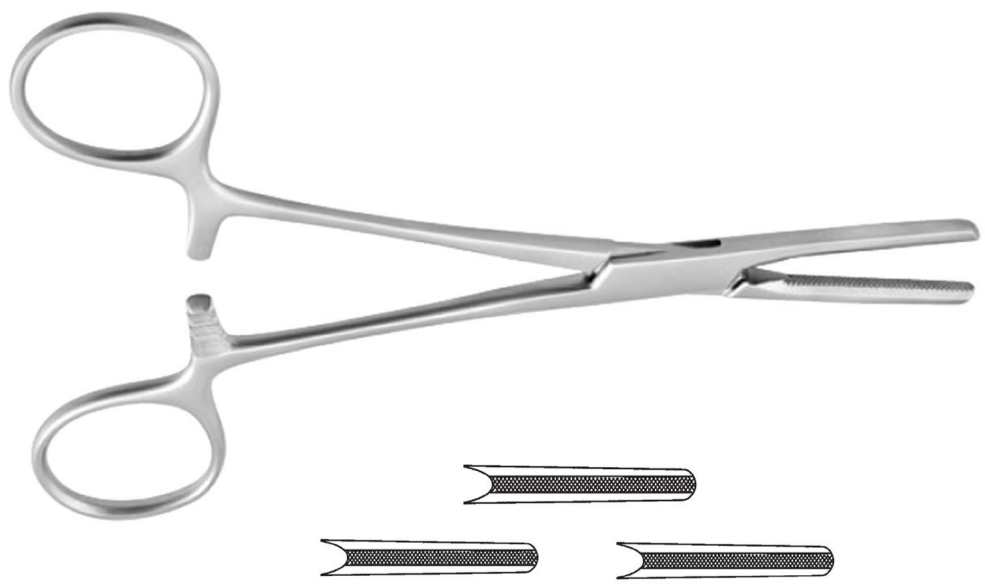

Description	Length	Code
Tubing Clamp Forceps	15 cm	BF-844-15
Tubing Clamp Forceps	18 cm	BF-844-18
Tubing Clamp Forceps	19 cm	BF-844-19
Tubing Clamp Forceps	20 cm	BF-844-20

Tubing Clamp With Guard Forceps Straight



Description	Length	Code
Tubing Clamp with Guard Forceps	15 cm	BF-846-15
Tubing Clamp with Guard Forceps	18 cm	BF-848-18
Tubing Clamp with Guard Forceps	20 cm	BF-848-20

O'Shaugnessy Artery Forceps



Description

O'Shaugnessy Artery Forceps
 O'Shaugnessy Artery Forceps
 O'Shaugnessy Artery Forceps
 O'Shaugnessy Artery Forceps
 O'Shaugnessy Artery Forceps

Length

15 cm
 18 cm
 20 cm
 23 cm
 26 cm

Code

BF-368-15
 BF-368-18
 BF-368-20
 BF-368-23
 BF-368-26

Gregory Suture Tag Forceps



Description

Suture Tag Forceps

Length

9 cm

Code

BF-410-09



SKILL[®]

Surgical Instruments

CARDIOVASCULAR RETRACTORS

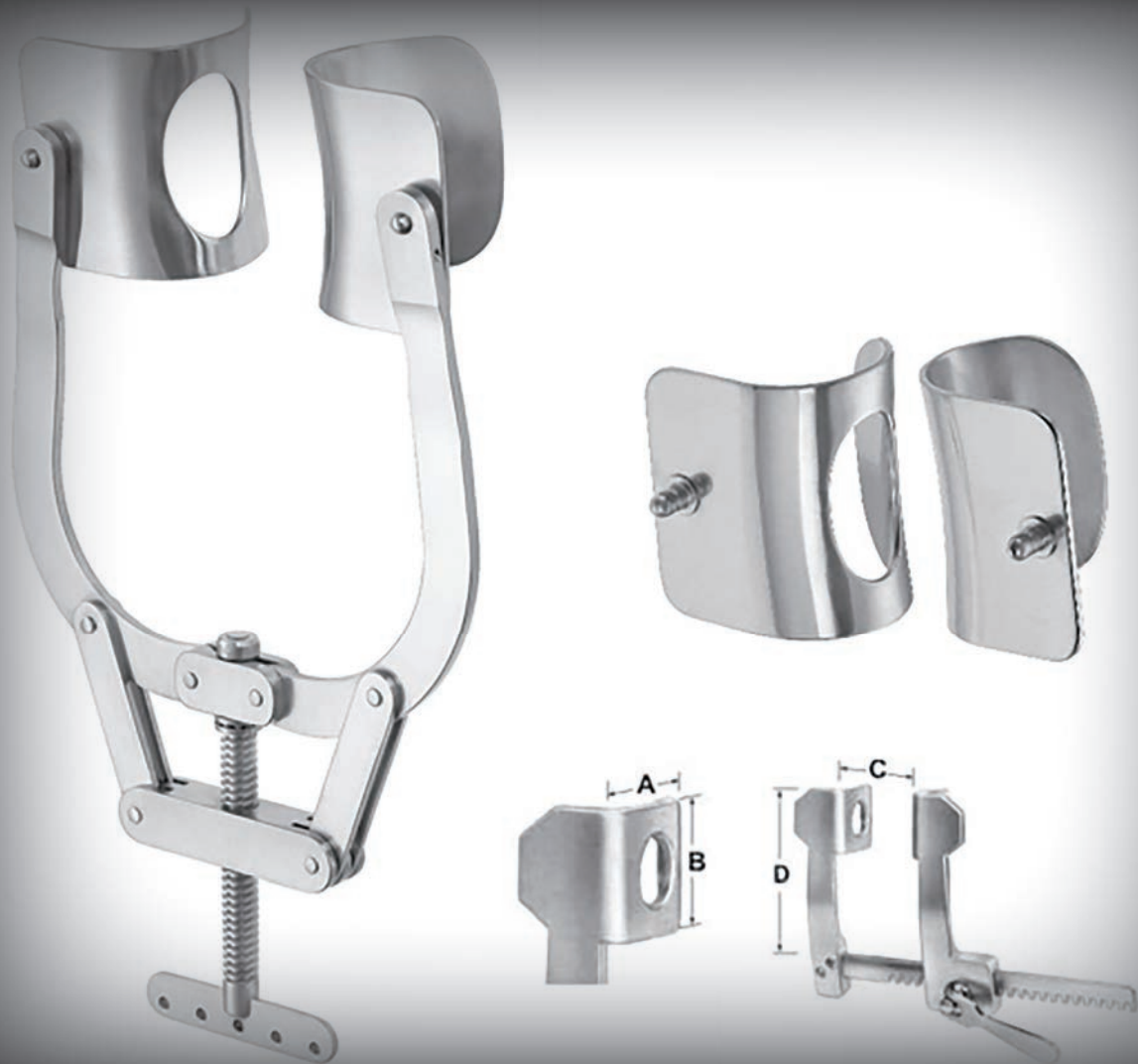

Index

Cardiovascular Retractors

Bailey Cardiovascular Retractor Lemmon Cardiovascular Retractor	264
Tuffier Cardiovascular Retractor Stainless Steel	265
Badgley Cardiovascular Retractor Stainless Steel	266
Rienhoff Cardiovascular Retractor Stainless Steel	266-267
Baby Haight Cardiovascular Retractor Stainless Steel	267
Burford Cardiovascular Retractor	268
Finochietto Baby Cardiovascular Retractor	268-271
Morse Child Cardiovascular Retractor Stainless Steel	272
Favaloro-Morse Cardiovascular Retractor Stainless Steel	272
DeBakey with 3-Set of Blades Cardiovascular Retractor	273
Ankeney Child Cardiovascular Retractor Stainless Steel	274
Haight-Finochietto Cardiovascular Retractor Aluminium	274
Burford-Finochietto Cardiovascular Retractor Aluminium	275
Castaneda Cardiovascular Retractor Aluminium	276
Cooley Cardiovascular Retractor Aluminium	276
Bailey Finochietto Cardiovascular Retractor Aluminium	277
Cooley Cardiovascular Retractor Stainless Steel	277
Finochietto Micro Neonatal Cardiovascular Retractor Stainless Steel	278
Morse Neonatal Cardiovascular Retractor Black Coated	278
Titanium Mini Micro Neonatal Cardiovascular Retractor	279
Neonatal Finochietto Retractor	279
Swivel Blades Cardiovascular Retractor Stainless Steel	280
DeBakey Klein Cardiovascular Retractor Stainless Steel	282
DeBakey Grob Cardiovascular Retractor Stainless Steel	282
Harken Cardiovascular Retractor DuBost Cardiovascular Retractor Stainless Steel	283
Morse Cardiovascular Retractor Aluminium	284-286
Finochietto-Baby-Haight Cardiovascular Retractor Aluminium	286-290
Burford Cardiovascular Retractor Aluminium	291-292
Skill Cardiovascular Retractor Aluminium Cooley Skill-Ankeney Weinberg Braastad Struck	293-304
Skill-DeBakey Cardiovascular Retractor Stainless Steel DuBost IMA IMA Cardiobase	305-308
Snap in Coupling for attachments Morse Blades Cooley Blades	309
Malleable Hook	310
Ross Retractor Serrated Cardiobase Retractor Marberger Retractor Cardiobase Retractor	311
Cooley-type Rake Retractor Malleable Cardiobase Retractor	311-312

Malleable Blade Retractor Cardiobase Retractor	312
Removable Blades IMA Retractor System	313
Cooley Mitral Retractor System	314-315
IMA Couetil Retractor	316-317
Carpentier Mitral Valve Retractors	318-319
Thorax Lifting Retractor French Model Mini IMA Retractor	320
McCarthy Mini Sternotomy Retractor System	321
Sellors Rib Spreader Stainless Steel	322
Volkmann Retractor	323-325
Koerte Retractor	326
Israel Retractor	327
Kocher Langenbeck Retractor	328
Jefferson Retractor Valve Retractor	329
Desmarres Open Lid Retractor	330-331
Ross Retractor	332
Cooley Atrium Retractor With Serrated Teeth Davidson Scapula Retractor	334
Copper Retractor Malleable	335
Cushing Lid Retractor	336
Kirklin Lid Retractor	337
Gill-Vernet Malleable Retractor	338
Murphy Retractor	339
Senn Miller Double Ended Retractor Czerny Double Ended Retractor	340
Kocher Langenbeck Retractor	341-343
Ross Retractor Serrated Marberger Retractor Cooley-type Rake Retractor Malleable	344
Harrington Cardio Retractors	345
Deaver Retractor DuBost Hand Retractor	346
Allison Hand Retractor	347
Memory (Nitinol) Retractor Malleable Epicardial Retractor 3x3 Teeth	348
Alm Retractor Weitlander Retractor	349
Anderson Adson Retractor	350
Travers Retractor Ionescu Handheld Valve Retractor	351-352
SKILL Atraumatic Retraction System	353
SKILL Cooley Atrial Blades, Shaft Diameter, 6 mm	354
MIDCAB Retractor System Complete	355
MIDCAB Retractor System Complete Blades and Stabilizer	356
MIDCAB Retractor Only Double Joint MIDCAB Adapter	357
MIDCAB Double Blades (solid individually)	358
SKILL MICS Aortic Clamp Set	359-361
SKILL MICS Atrial Blade Set	362

CARDIOVASCULAR RETRACTOR

Bailey Cardiovascular Retractor**Description**

Bailey Retractor A = 19 mm

Bailey Paediatric Retractor A = 18 mm

Bailey Gibon Retractor A = 29 mm

Length

18 cm

14 cm

18 cm

Code

DA-1200-18

DA-1201-14

DA-1202-18

Lemmon Cardiovascular Retractor**Description**

Lemmon Retractor for Children

Lemmon Retractor Large

Length

14 cm

18 cm

Code

DA-1205-14

DA-1206-18

Tuffier Cardiovascular Retractor Stainless Steel

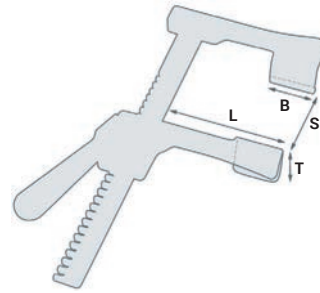

S	L	B	T
178 mm	108 mm	45 mm	48 mm

Description

Tuffier Retractor

Code

DA-1207-00

Tuffier Cardiovascular Retractor Stainless Steel

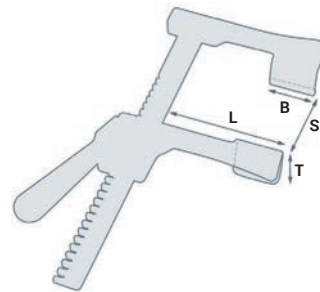

S	L	B	T
178 mm	107 mm	45 mm	48 mm

Description

Tuffier Retractor

Code

DA-1208-00

Badgley Cardiovascular Retractor Stainless Steel

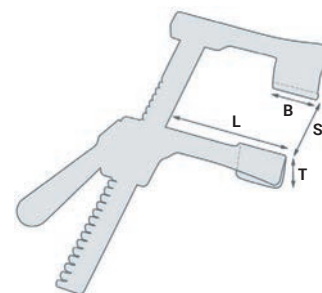

Blades with 4 prongs

S	L	B	T
165 mm	108 mm	45 mm	50 mm

Description

Badgley Retractor

Code

DA-1209-00

Rienhoff Cardiovascular Retractor Stainless Steel

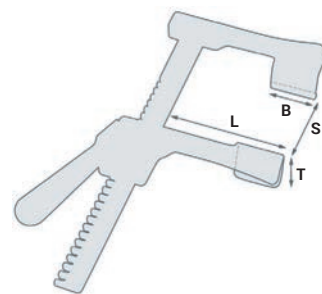

S	L	B	T
140 mm	116 mm	33 mm	30 mm

Description

Rienhoff Retractor

Code

DA-1210-00

Rienhoff Cardiovascular Retractor Stainless Steel

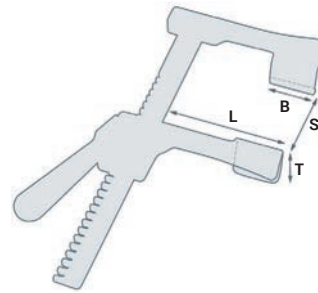

S	L	B	T
140 mm	146 mm	45 mm	47 mm

Description

Rienhoff Retractor

Code

DA-1211-00

Baby Haight Cardiovascular Retractor Stainless Steel

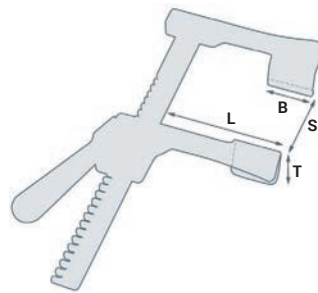

	S	L	B	T
A	126 mm	64 mm	31 mm	32 mm
B	126 mm	90 mm	31 mm	32 mm

Description

A Baby Haight Retractor

B Baby Haight Retractor

Code

DA-1212-00

DA-1213-00

Burford Cardiovascular Retractor

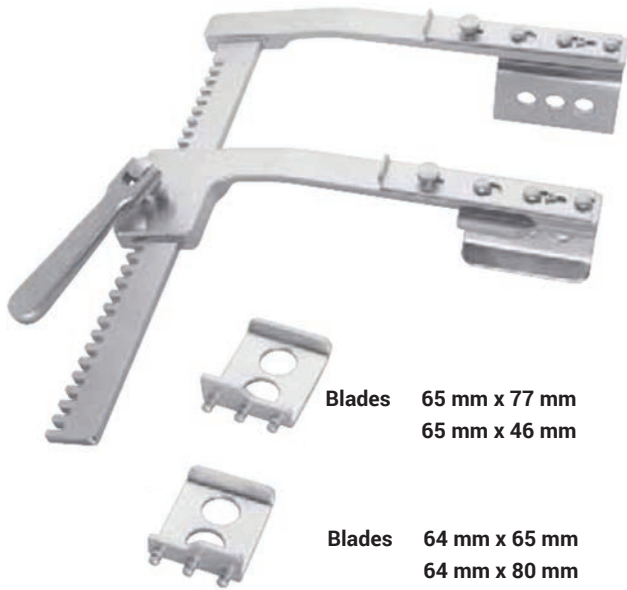

Blades 65 mm x 77 mm
65 mm x 46 mm

Blades 64 mm x 65 mm
64 mm x 80 mm

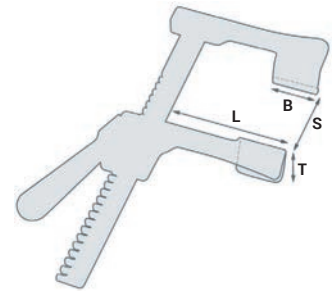

	S	L	B	T
A	208 mm	192 mm	65 mm	77 mm
B	200 mm	205 mm	65 mm	46 mm

Description

- A Burford Retractor
- B Burford Retractor

Code

- DA-1214-00
- DA-1215-00

Burford-Finochietto Child Cardiovascular Retractor Stainless Steel

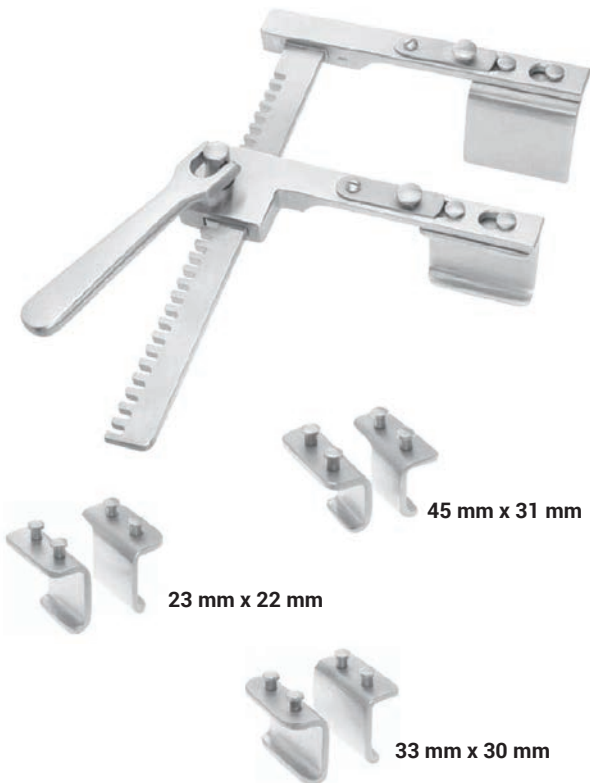

45 mm x 31 mm

23 mm x 22 mm

33 mm x 30 mm

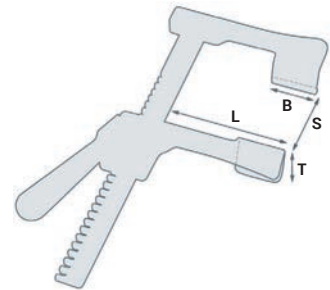

S	L	B	T
157 mm	108 mm	44 mm	47 mm

Description

Burford-Finochietto Child

Code

DA-1216-00

**Finochietto Baby Straight Arms Cardiovascular Retractor
Stainless Steel**

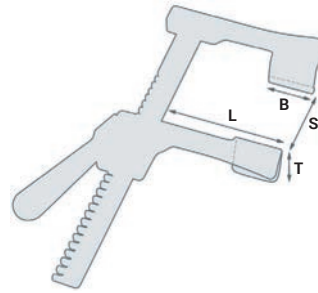

	S	L	B	T
A	55 mm	51 mm	15 mm	13 mm
B	75 mm	51 mm	15 mm	13 mm
C	80 mm	60 mm	21 mm	18 mm

Description

- A** Finochietto Baby Retractor
- B** Finochietto Baby Retractor
- C** Finochietto Baby Retractor

Code

- DA-1217-00
- DA-1218-00
- DA-1219-00

**Finochietto Baby Curved Arms Cardiovascular Retractor
Stainless Steel**

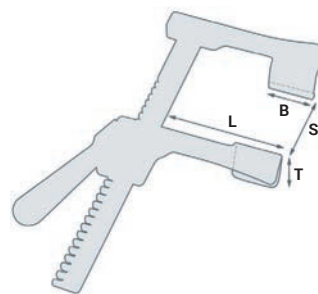

	S	L	B	T
	80 mm	60 mm	21 mm	18 mm

Description

Finochietto Baby Retractor

Code

DA-1220-00

CARDIOVASCULAR RETRACTOR

Finochietto Baby Curved Arms With Circular Fenestration Cardiovascular Retractor Stainless Steel

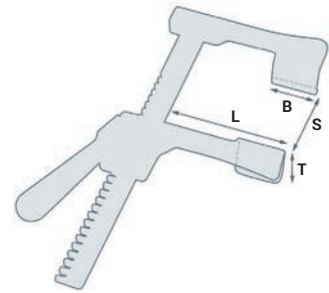

S	L	B	T
150 mm	111 mm	32 mm	28 mm

Description

Finochietto Baby Retractor

Code

DA-1221-00

Finochietto Baby Cardiovascular Retractor Stainless Steel

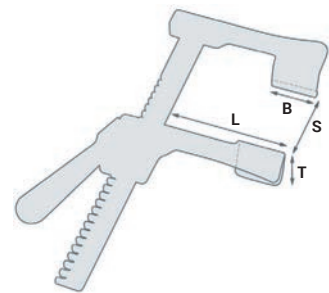

S	L	B	T
80 mm	68 mm	21 mm	19 mm

Description

Finochietto Baby Retractor

Code

DA-1222-00

Finochietto Straight Arms Cardiovascular Retractor Stainless Steel

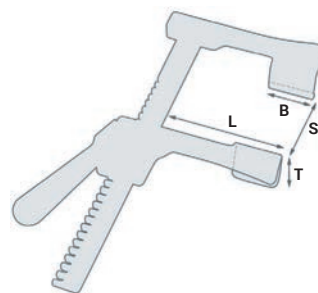

	S	L	B	T
A	200 mm	186 mm	66 mm	51 mm
B	265 mm	186 mm	66 mm	51 mm
C	310 mm	186 mm	66 mm	51 mm

Description

- A** Finochietto Retractor
- B** Finochietto Retractor
- C** Finochietto Retractor

Code

- DA-1223-00
- DA-1224-00
- DA-1225-00

Finochietto Curved Arms Cardiovascular Retractor Stainless Steel

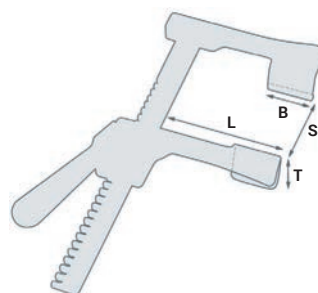

	S	L	B	T
A	148 mm	130 mm	45 mm	40 mm
B	200 mm	162 mm	65 mm	50 mm
C	200 mm	130 mm	65 mm	50 mm
D	200 mm	180 mm	65 mm	50 mm
E	220 mm	180 mm	65 mm	70 mm
F	250 mm	180 mm	65 mm	70 mm

Description

- A** Finochietto Retractor
- B** Finochietto Retractor
- C** Finochietto Retractor
- D** Finochietto Retractor
- E** Finochietto Retractor
- F** Finochietto Retractor

Code

- DA-1226-00
- DA-1227-00
- DA-1228-00
- DA-1229-00
- DA-1230-00
- DA-1231-00

Morse Child Cardiovascular Retractor Stainless Steel

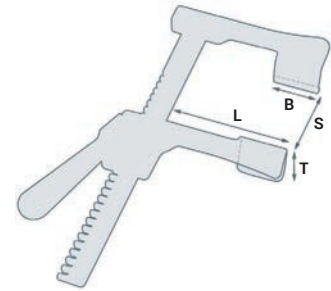

S	L	B	T
154 mm	125 mm	22 mm	15 mm

Description

Morse Child Retractor

Code

DA-1232-00

Favaloro-Morse Cardiovascular Retractor Stainless Steel

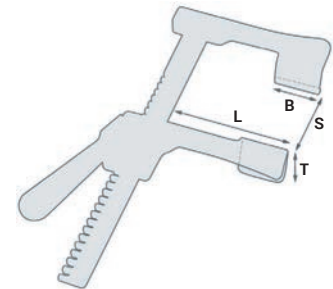

	S	L	B	T
A	212 mm	148 mm	29 mm	23 mm
B	212 mm	148 mm	29 mm	38 mm
C	212 mm	205 mm	29 mm	38 mm
D	170 mm	148 mm	29 mm	34 mm

Description

- A** Morse Retractor
- B** Favaloro-Morse Retractor
- C** Favaloro-Morse Retractor
- D** Pacifico-Morse Retractor

Code

- DA-1233-00
- DA-1234-00
- DA-1235-00
- DA-1236-00

**DeBakey with 3-Set of Blades Cardiovascular Retractor
Stainless Steel**

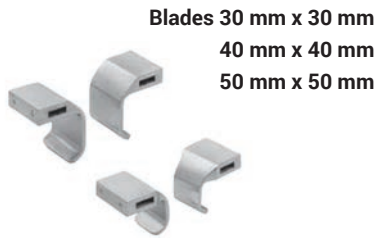
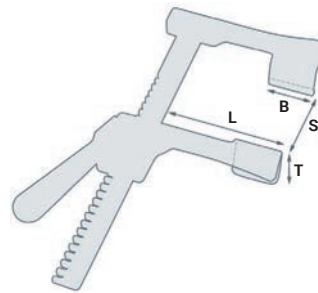
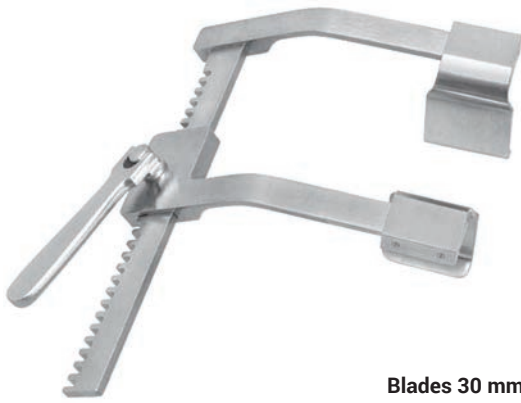

S	L	B	T
192 mm	153 mm	40 mm	40 mm

Description

DeBakey Retractor

Code

DA-1237-00

**DeBakey with 3-Set of Blades Cardiovascular Retractor
Stainless Steel**

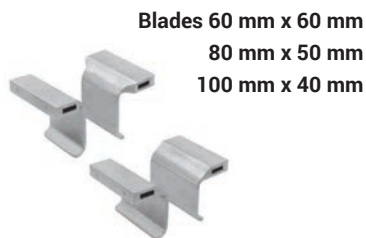
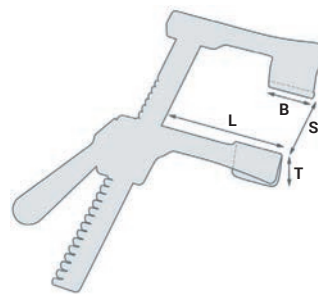
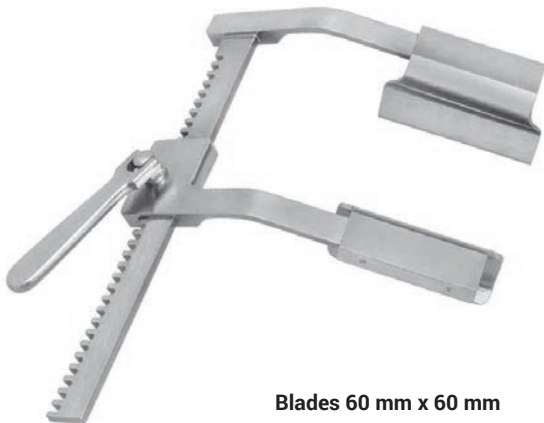

S	L	B	T
240 mm	170 mm	60 mm	60 mm

Description

DeBakey Retractor

Code

DA-1238-00

CARDIOVASCULAR RETRACTOR

Ankeney Child Cardiovascular Retractor Stainless Steel

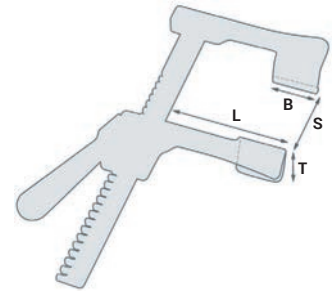

	S	L	B	T
A	139 mm	114 mm	19 mm	23 mm
B	195 mm	289 mm	35 mm	35 mm

Description

Ankeney Retractor
Ankeney Retractor

Code

DA-1239-00
DA-1240-00

Haight-Finochietto Cardiovascular Retractor Aluminium

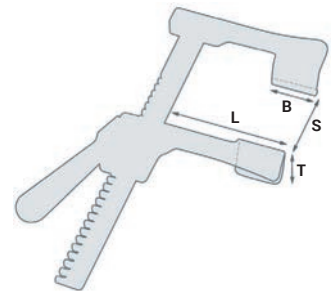

	S	L	B	T
	98 mm	76 mm	31 mm	31 mm

Description

Haight-Finochietto Retractor

Code

DA-1241-00

Burford-Finochietto Cardiovascular Retractor Aluminium

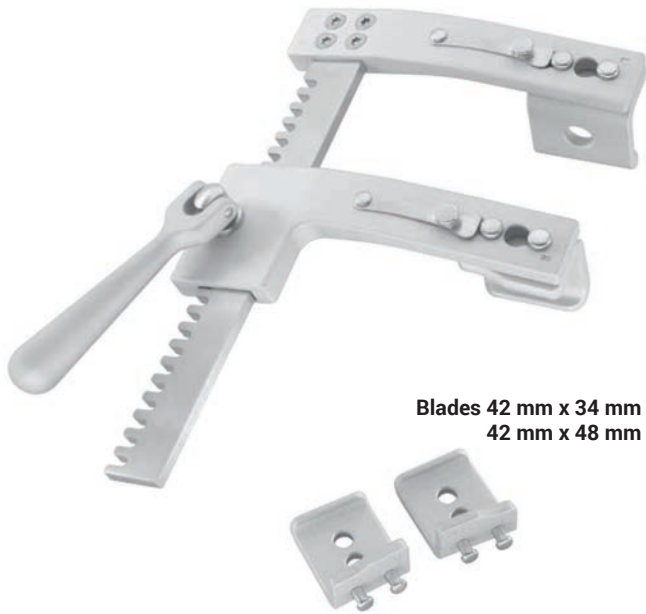

Blades 42 mm x 34 mm
42 mm x 48 mm

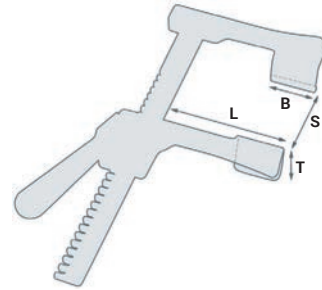

S	L	B	T
135 mm	113 mm	42 mm	48 mm

Description

Burford-Finochietto Retractor

Code

DA-1242-00

Burford-Finochietto Cardiovascular Retractor Aluminium

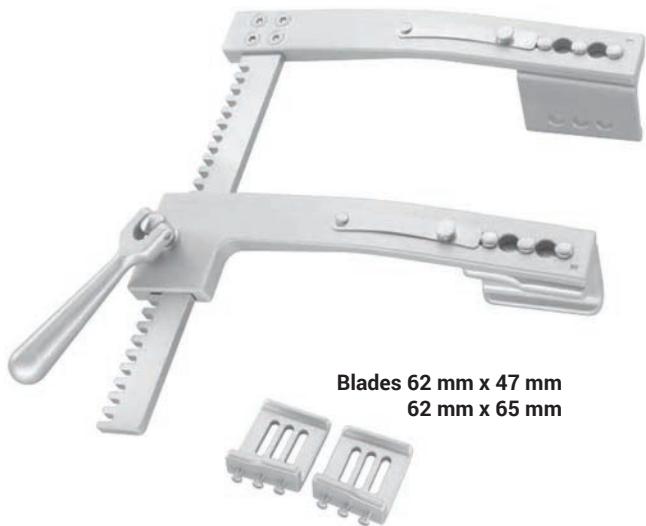

Blades 62 mm x 47 mm
62 mm x 65 mm

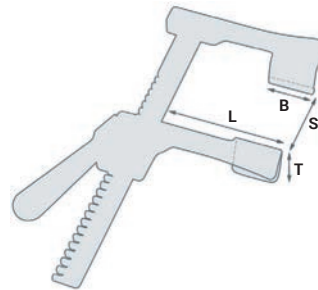

	S	L	B	T
A	200 mm	197 mm	62 mm	47 mm
B	288 mm	197 mm	62 mm	47 mm
C	330 mm	197 mm	62 mm	47 mm

Description

- A** Burford-Finochietto Retractor
- B** Burford-Finochietto Retractor
- C** Burford-Finochietto Retractor

Code

- DA-1243-00
- DA-1244-00
- DA-1245-00

CARDIOVASCULAR RETRACTOR

Castaneda Cardiovascular Retractor Aluminium

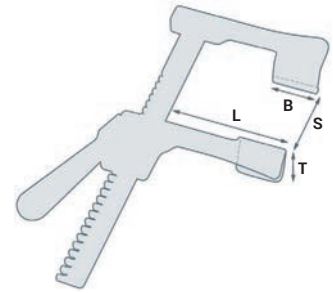

	S	L	B	T
A	74 mm	60 mm	34 mm	11 mm
B	80 mm	80 mm	45 mm	13 mm
C	110 mm	126 mm	60 mm	17 mm

Description

- A** Castaneda Retractor
- B** Castaneda Retractor
- C** Castaneda Retractor

Code

- DA-1246-00
- DA-1247-00
- DA-1248-00

Cooley Cardiovascular Retractor Aluminium

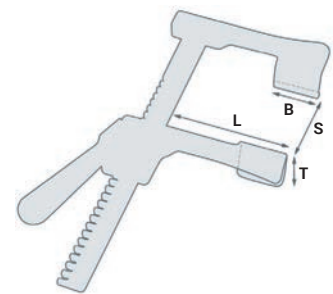

	S	L	B	T
A	74 mm	58 mm	17 mm	11 mm
B	101 mm	80 mm	30 mm	17 mm
C	74 mm	58 mm	17 mm	13 mm

Description

- A** Cooley Neonatal Retractor
- B** Cooley Small Child Retractor
- C** Cooley Child Retractor

Code

- DA-1249-00
- DA-1250-00
- DA-1251-00

Bailey Finochietto Cardiovascular Retractor Aluminium

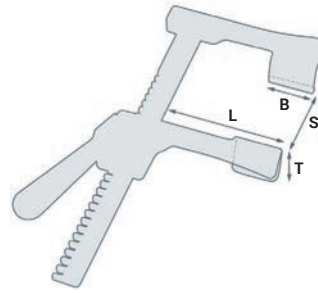

S	L	B	T
74 mm	58 mm	14 mm	12 mm

Description

Bailey Finochietto Retractor

Code

DA-1252-00

Cooley Cardiovascular Retractor Stainless Steel

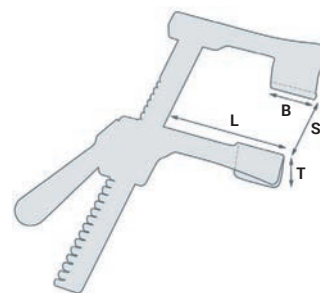

	S	L	B	T
A	137 mm	112 mm	46 mm	25 mm
B	170 mm	140 mm	52 mm	34 mm

Description

- A** Cooley Retractor
- B** Cooley Retractor

Code

- DA-1253-00
- DA-1254-00

CARDIOVASCULAR RETRACTOR

Finochietto Micro Neonatal Cardiovascular Retractor Stainless Steel

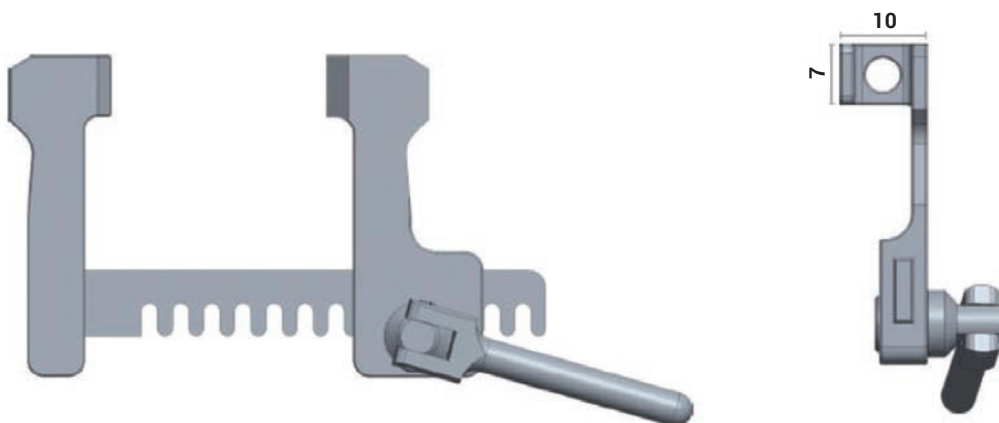

S	L	B	T
32 mm	59 mm	10 mm	7 mm

Description

Finochietto Retractor

Code

DA-3050-00

Morse Neonatal Cardiovascular Retractor Black Coated

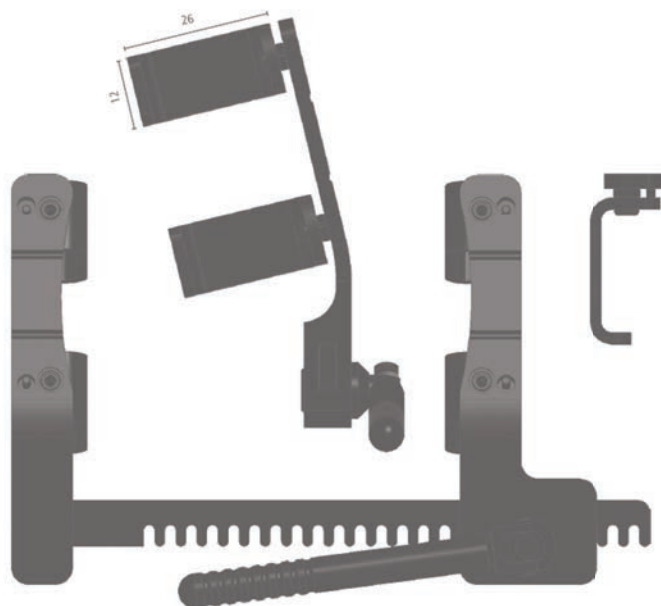

S	L	B	T
65 mm	109 mm	40 mm	12 mm

Description

Morse Neonatal Cardiovascular Retractor

Code

DA-3077-00

Titanium Mini Micro Neonatal Cardiovascular Retractor



	Overall Length	Overall Height	Max. Spread
A	77 mm	53 mm	39 mm



Full Blades

	Blade Depth	Blade Width	Type
B	15 mm	20 mm	Right
	15 mm	20 mm	Left

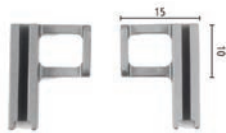

Fenstered Blades

	Blade Depth	Blade Width	Type
B	15 mm	20 mm	Right
	15 mm	20 mm	Left

Description

- A** Titanium Mini Micro Neonatal complete with Full Blades
- B** Titanium Mini Micro Neonatal complete with Fenstered Blades

Code

- DA-3160-01T
- DA-3160-02T

Neonatal Finochietto Retractor



S	L	B	T
6 mm	7 mm	37 mm	25 mm

Description

Neonatal Finochietto Retractor

Code

DA-3170-00

CARDIOVASCULAR RETRACTOR

Swivel Blades Cardiovascular Retractor Stainless Steel

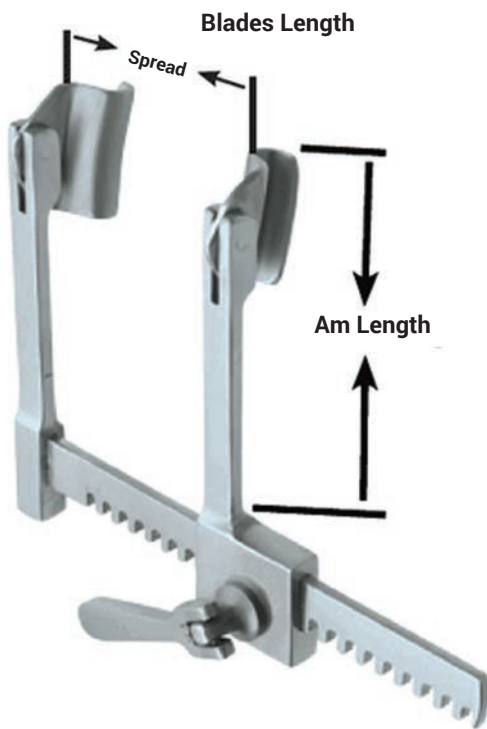
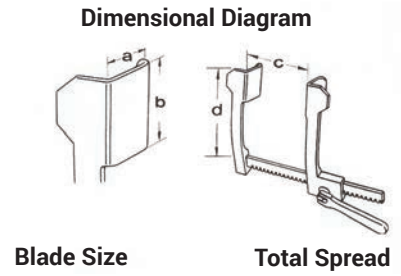
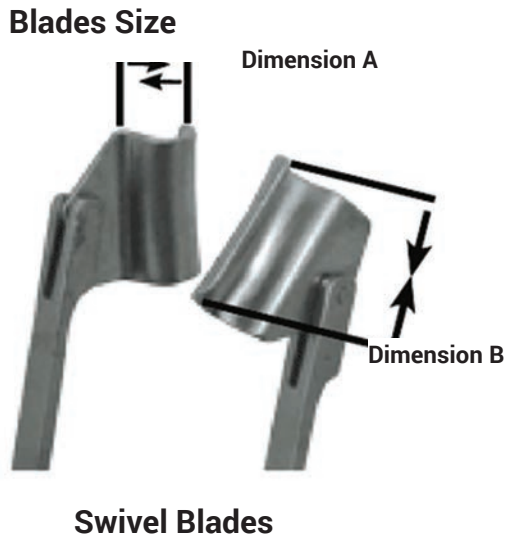

Skill Turn-Over Retractor Neonatal

With turn-over function of retractor body.

	A	B	C	D
A	20 mm	28 mm	65 mm	65 mm

Skill Turn-Over Retractor Infant

With turn-over function of retractor body.

	A	B	C	D
B	14 mm	45 mm	80 mm	75 mm

Skill Turn-Over Retractor Small-Child

With turn-over function of retractor body.

	A	B	C	D
C	18 mm	58 mm	90 mm	85 mm

Description

- A** Swivel Blades Cardiovascular Retractor
- B** Swivel Blades Cardiovascular Retractor
- C** Swivel Blades Cardiovascular Retractor

Code

- DA-3170-01
- DA-3170-02
- DA-3170-03



CARDIOVASCULAR RETRACTOR

DeBakey Klein Cardiovascular Retractor Stainless Steel

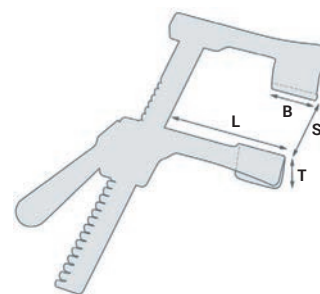

S	L	B	T
152 mm	144 mm	30 mm	30 mm

Description

DeBakey Klein Retractor

Code

DA-1255-00

DeBakey Grob Cardiovascular Retractor Stainless Steel

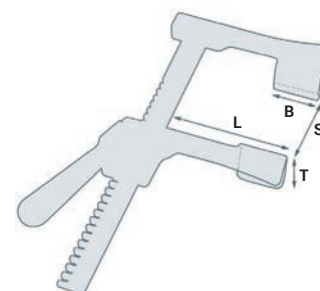

S	L	B	T
241 mm	189 mm	80 mm	50 mm

Description

DeBakey Grob Retractor

Code

DA-1256-00

Harken Cardiovascular Retractor

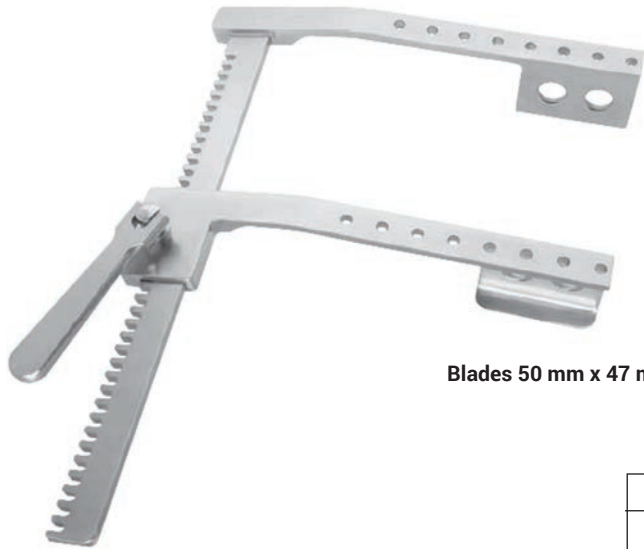

Blades 50 mm x 47 mm

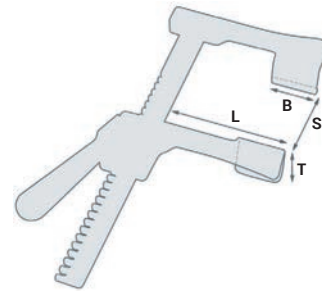

S	L	B	T
280 mm	210 mm	65 mm	49 mm

Description

Harken Retractor

Code

DA-1257-00

DuBost Cardiovascular Retractor Stainless Steel



Blades 100 mm x 30 mm



Blades 100 mm x 50 mm

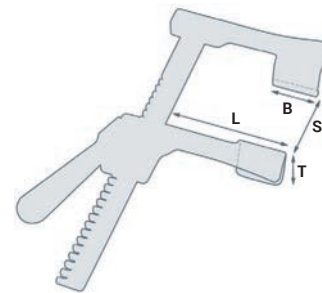

S	L	B	T
160 mm	140 mm	100 mm	40 mm

Description

DuBost Retractor

Code

DA-1258-00

Morse Cardiovascular Retractor Aluminium



Dimensional Diagram

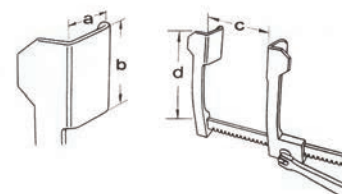

Blade Size

Total Spread

Morse Sternal

With double swivel blades, for adults, distance between blades 72 mm, arms curved between rack and blades. Aluminium natural grey.

Like Morse Sternal but arms curved between blades.

A	B	C	D
20 mm	28 mm	210 mm	155 mm

Description

Morse Cardiovascular Retractor Aluminium

Code

DA-1400-00

Morse Cardiovascular Retractor Aluminium



Dimensional Diagram

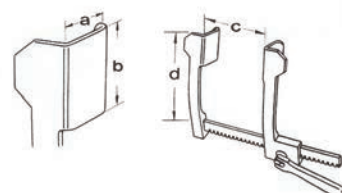

Blade Size

Total Spread

Morse Sternal

With double swivel blades, for children, distance between blades 50 mm, arms curved between rack and blades. Aluminium natural grey.

Like Morse Sternal but arms curved between blades.

A	B	C	D
20 mm	20 mm	155 mm	120 mm

Description

Morse Cardiovascular Retractor Aluminium

Code

DA-1401-00

Morse-Favaloro Cardiovascular Retractor Aluminium

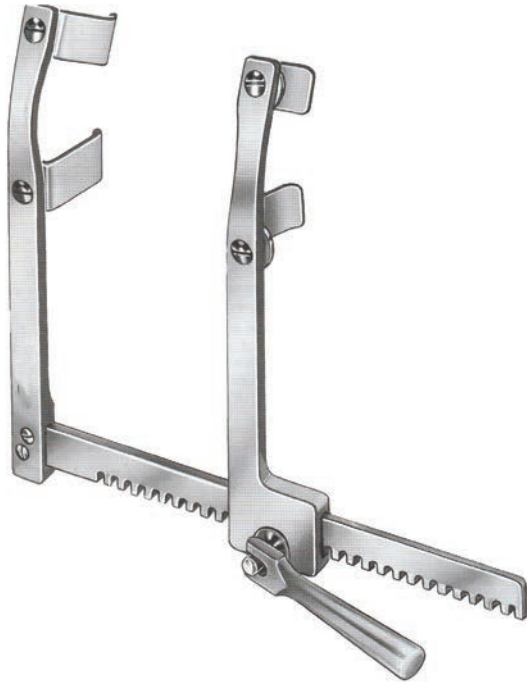

Dimensional Diagram

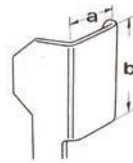

Blade Size

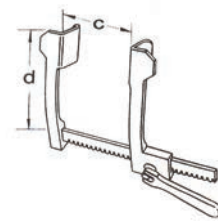

Total Spread

Morse-Favaloro Sternal

For adults, with double swivel blades, distance between blades 65 mm, arms curved between blades. Aluminium natural grey.

A	B	C	D
40 mm	20 mm	155 mm	175 mm

Description

Morse-Favaloro Cardiovascular Retractor Aluminium

Code

DA-1402-00

Morse-Favaloro Cardiovascular Retractor Aluminium



Dimensional Diagram

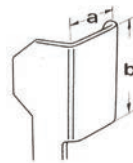

Blade Size

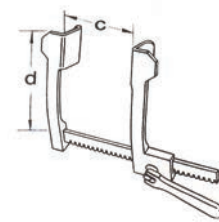

Total Spread

Morse-Favaloro Sternal

For children, with double swivel blades, distance between blades 50 mm, arms curved between blades. Aluminium natural grey.

A	B	C	D
40 mm	20 mm	155 mm	175 mm

Description

Morse-Favaloro Cardiovascular Retractor Aluminium

Code

DA-1403-00

Skill-Morse Cardiovascular Retractor Aluminium



Dimensional Diagram

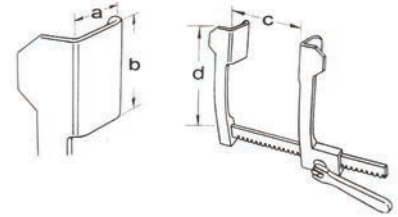

Blade Size

Total Spread

Skill-Morse Sternal

For adults, modified by Skill, extra large, with 3 pairs of swivel blades, distance between blades 42 mm. Aluminium natural grey.

A	B	C	D
30 mm	35 mm	200 mm	195 mm

Description

Skill-Morse Cardiovascular Retractor Aluminium

Code

DA-1404-00

Finochietto-Baby-Haight Cardiovascular Retractor Aluminium

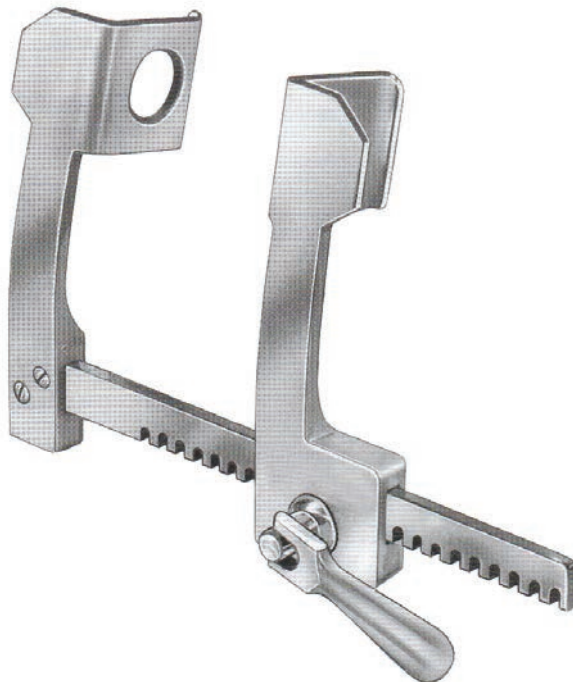

Dimensional Diagram

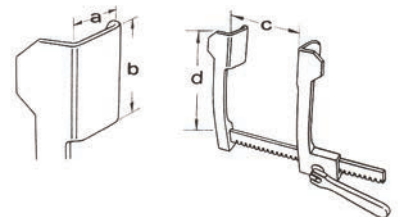

Blade Size

Total Spread

Finochietto-Baby-Haight

Child size. Aluminium natural grey.

A	B	C	D
27 mm	30 mm	95 mm	80 mm

Description

Finochietto-Baby-Haight Cardiovascular Retractor Aluminium

Code

DA-1405-00

Finochietto-Infant Cardiovascular Retractor Aluminium

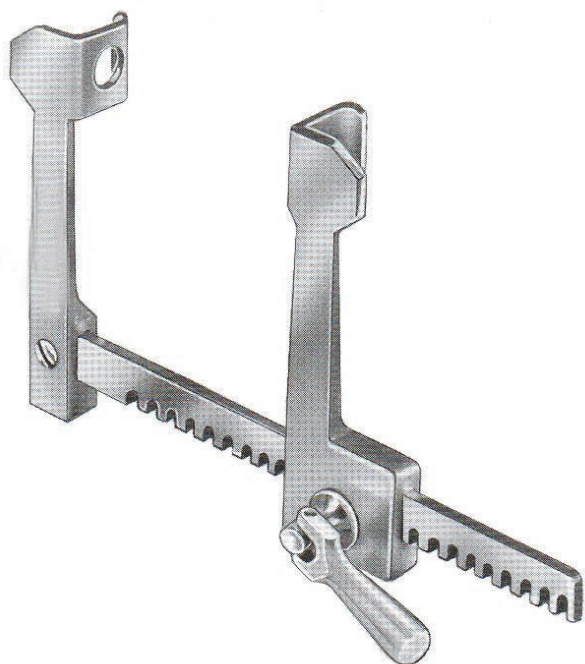

Dimensional Diagram

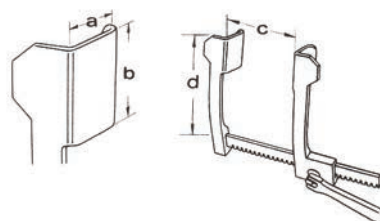

Blade Size

Total Spread

Finochietto-Infant
 Infant size.
 Aluminium natural grey.

A	B	C	D
12 mm	15 mm	70 mm	55 mm

Description

Finochietto-Infant Cardiovascular Retractor Aluminium

Code

DA-1406-00

Skill-Finochietto Cardiovascular Retractor Aluminium

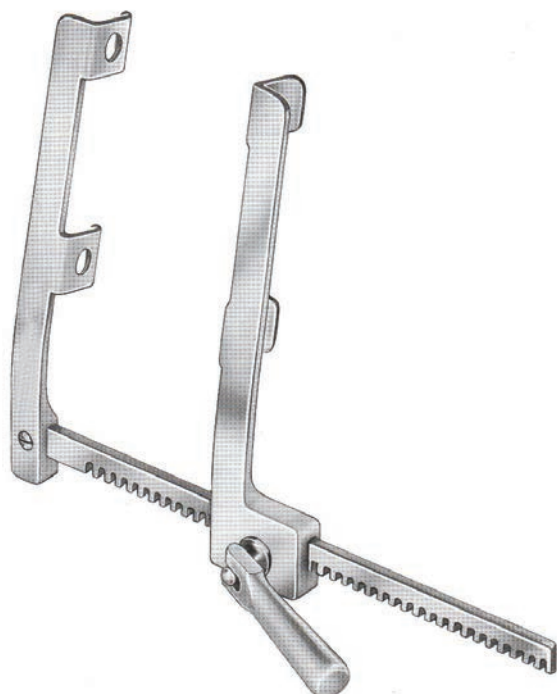

Dimensional Diagram

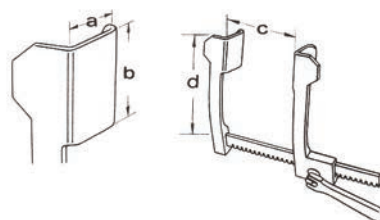

Blade Size

Total Spread

Skill-Finochietto
 Infant size. Two blades attached to each arm,
 40 mm distance between blades.
 Aluminium natural grey.

A	B	C	D
10 mm	15 mm	120 mm	105 mm

Description

Skill-Finochietto Cardiovascular Retractor Aluminium

Code

DA-1407-00

Finochietto Cardiovascular Retractor Aluminium

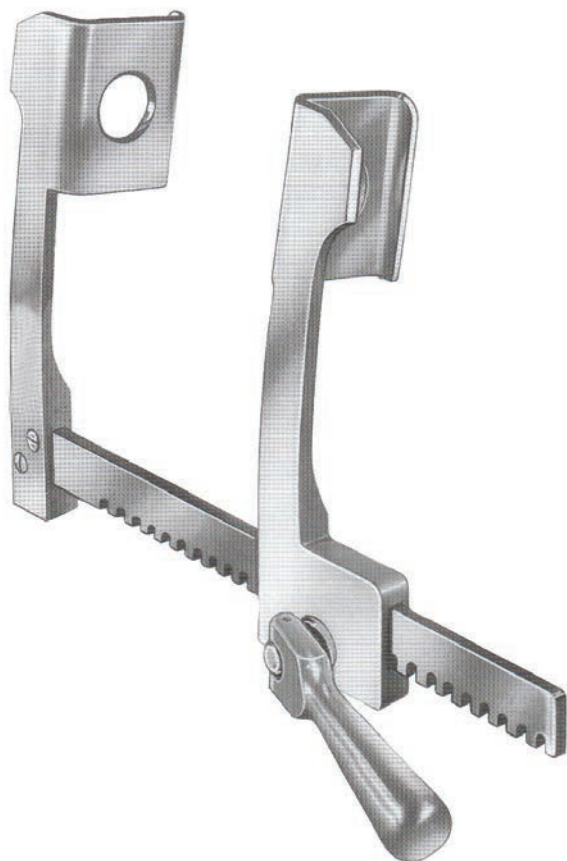

Dimensional Diagram

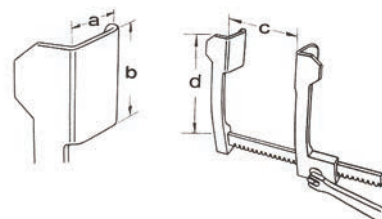

Blade Size

Total Spread

Finochietto

Small size for children too.
Aluminium natural grey.

A	B	C	D
30 mm	45 mm	140 mm	110 mm

Description

Finochietto Cardiovascular Retractor Aluminium

Code

DA-1408-00



Finochietto Cardiovascular Retractor Aluminium

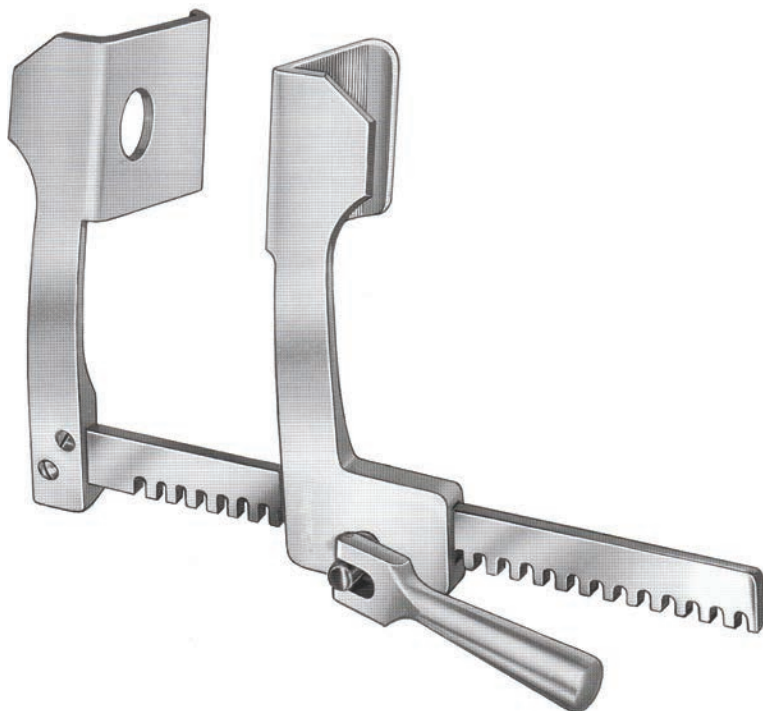

Dimensional Diagram

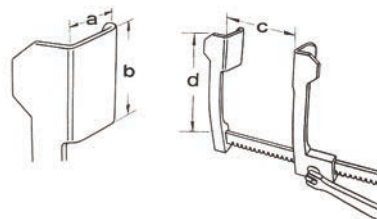

Blade Size

Total Spread

Finochietto
Large size for adults.
Aluminium natural grey.

A	B	C	D
73 mm	65 mm	170 mm	140 mm

Description

Finochietto Cardiovascular Retractor Aluminium

Code

DA-1409-00

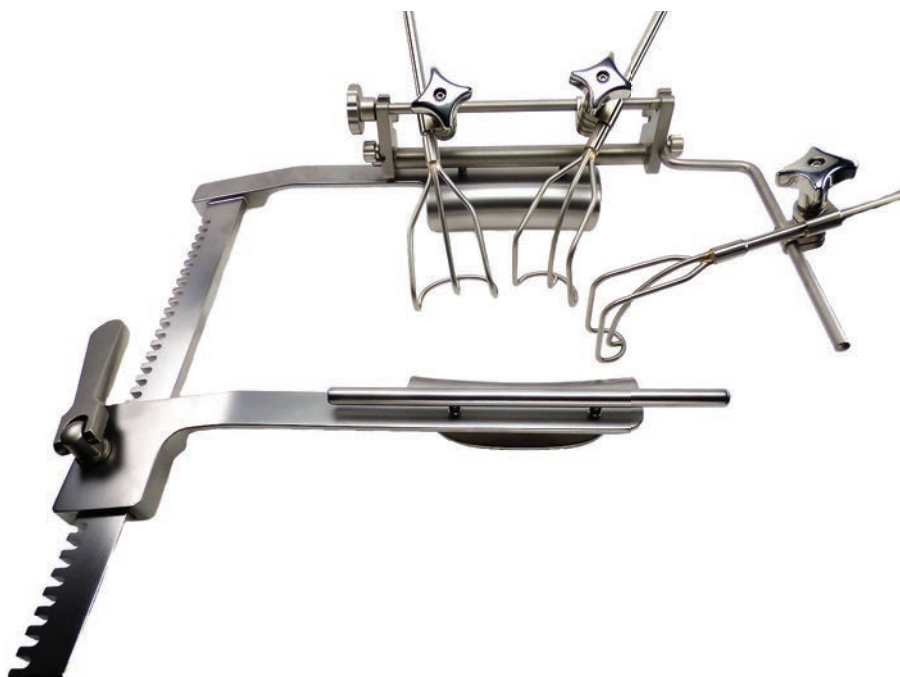

CARDIOVASCULAR RETRACTOR

Finochietto Cardiovascular Retractor Aluminium

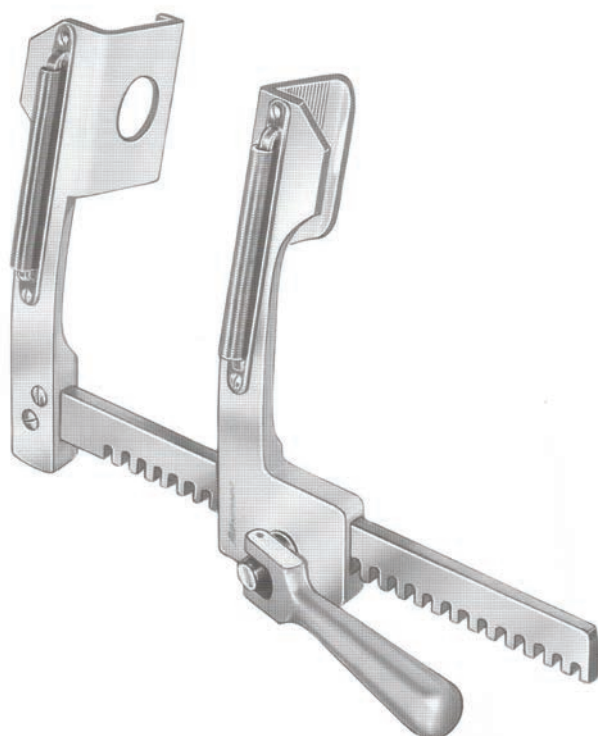

Dimensional Diagram

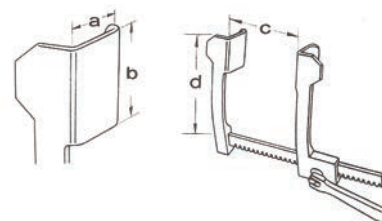

Blade Size

Total Spread

Finochietto

Medium size for adults with suture separator.
Aluminium natural grey.

A	B	C	D
42 mm	62 mm	170 mm	140 mm

Description

Finochietto Cardiovascular Retractor Aluminium

Code

DA-1410-00

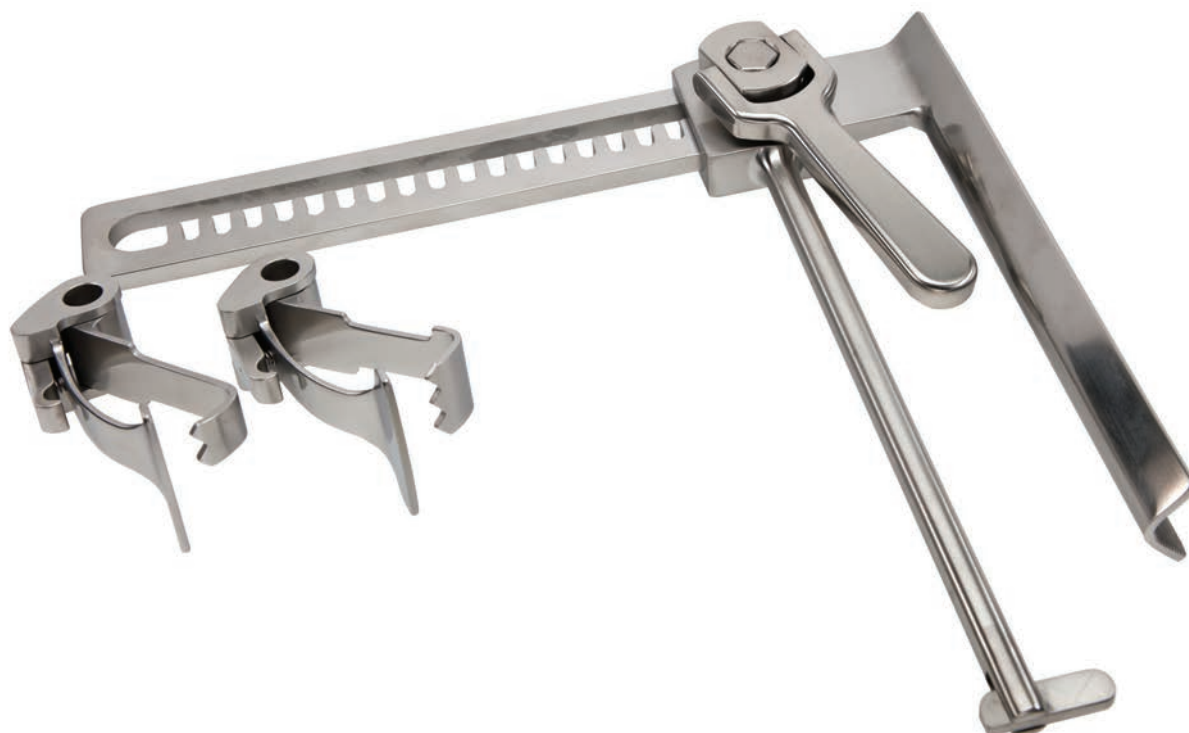

Burford Cardiovascular Retractor Aluminium

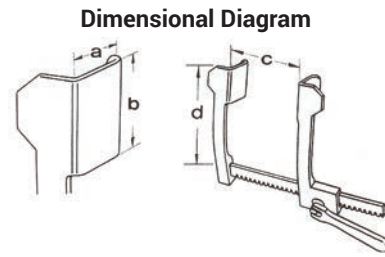
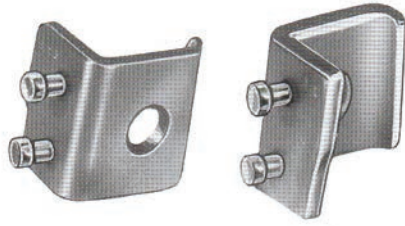

Blade Size

Total Spread



Burford

Child size, with two pairs of interchangeable blades, small and large. Aluminium natural grey.

A1	B1	A2	B2	C	D
30 mm	42 mm	41 mm	42 mm	130 mm	117 mm

Pair of Blades

A	B
30 mm	42 mm
41 mm	42 mm

Description

Burford Cardiovascular Retractor Aluminium

Burford Cardiovascular Retractor Aluminium Pair of Blades 30 mm, 42 mm

Burford Cardiovascular Retractor Aluminium Pair of Blades 41 mm, 42 mm

Code

DA-1411-00

DA-1412-00

DA-1413-00



CARDIOVASCULAR RETRACTOR

CARDIOVASCULAR RETRACTOR

Burford Cardiovascular Retractor Aluminium



Dimensional Diagram

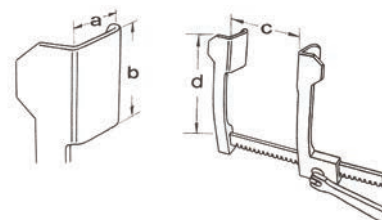

Blade Size

Total Spread

Burford 165 mm

Adult size, with two pairs of interchangeable blades, small and large.
Aluminium natural grey.

A1	B1	A2	B2	C	D
45 mm	62 mm	65 mm	62 mm	165 mm	200 mm

Burford 250 mm

Standard size for adults with two pairs of interchangeable blades, small and large.
Aluminium natural grey.

A1	B1	A2	B2	C	D
45 mm	62 mm	65 mm	62 mm	250 mm	200 mm

Burford 290 mm

For adults with two pairs of interchangeable blades, small and large.
Aluminium natural grey.

A1	B1	A2	B2	C	D
45 mm	62 mm	62 mm	62 mm	290 mm	200 mm

Pair of Blades

A	B
45 mm	62 mm
65 mm	62 mm

Description

Burford Cardiovascular Retractor Aluminium 165 mm

Burford Cardiovascular Retractor Aluminium 250 mm

Burford Cardiovascular Retractor Aluminium 290 mm

Burford Cardiovascular Retractor Aluminium Pair of Blades 45 mm, 62 mm

Burford Cardiovascular Retractor Aluminium Pair of Blades 65 mm, 62 mm

Code

DA-1444-00

DA-1445-00

DA-1446-00

DA-1447-00

DA-1448-00

Skill Cardiovascular Retractor Aluminium



Dimensional Diagram

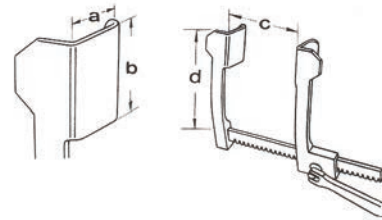

Blade Size

Total Spread

Skill Sternal

Neonatal, with concave-convex blades.
Aluminium natural grey.

A	B	C	D
16 mm	30 mm	65 mm	55 mm

Description

Skill Cardiovascular Retractor Aluminium

Code

DA-1449-00

Skill Cardiovascular Retractor Aluminium

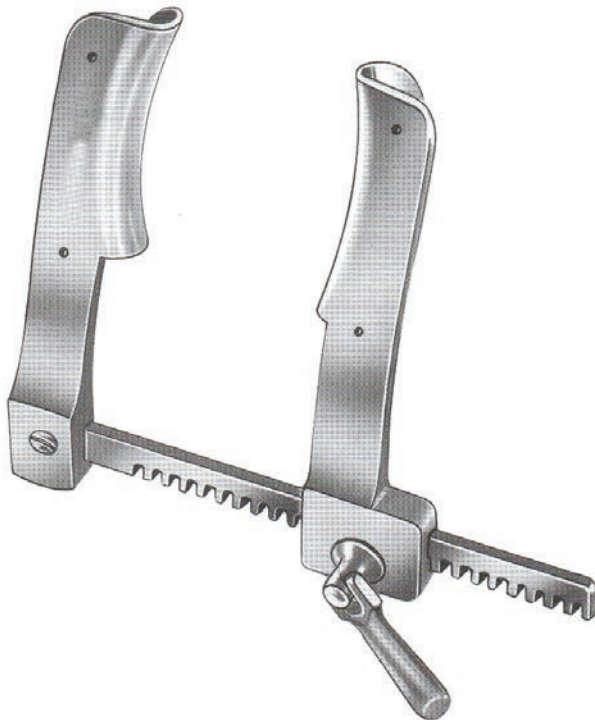

Dimensional Diagram

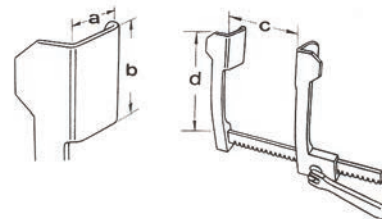

Blade Size

Total Spread

Skill Sternal

For babies with concave-convex blades.
Aluminium natural grey.

A	B	C	D
12 mm	45 mm	72 mm	80 mm

Description

Skill Cardiovascular Retractor Aluminium

Code

DA-1450-00

Skill Cardiovascular Retractor Aluminium



Dimensional Diagram

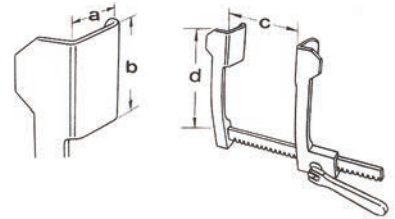

Blade Size

Total Spread

Skill Sternal

Child size with concave-convex blades.
Aluminium natural grey.

A	B	C	D
15 mm	60 mm	100 mm	125 mm

Description

Skill Cardiovascular Retractor Aluminium

Code

DA-1451-00

Skill Cooley Cardiovascular Retractor Aluminium



Dimensional Diagram

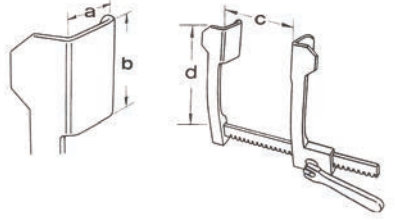

Blade Size

Total Spread

Skill Cooley

With swivel convex blades for babies.
Aluminium natural grey.

A	B	C	D
10 mm	15 mm	90 mm	75 mm

Description

Skill Cooley Cardiovascular Retractor Aluminium

Code

DA-1452-00

Skill Cooley Cardiovascular Retractor Aluminium



Dimensional Diagram

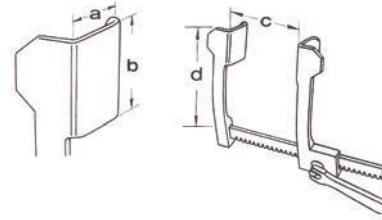

Blade Size

Total Spread

Skill Cooley

With swivel blades for babies.
Aluminium natural grey.

A	B	C	D
10 mm	15 mm	90 mm	75 mm

Description

Skill Cooley Cardiovascular Retractor Aluminium

Code

DA-1453-00

Cooley Cardiovascular Retractor Aluminium

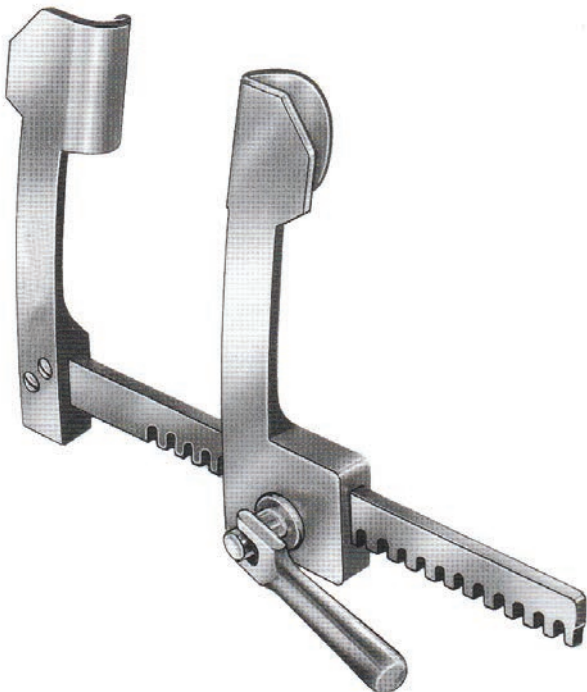

Dimensional Diagram

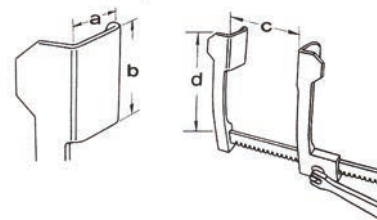

Blade Size

Total Spread

Cooley

Paediatric size, sternal spreader,
light-weight but sturdy.
Aluminium natural grey.

A	B	C	D
15 mm	30 mm	115 mm	80 mm

Description

Cooley Cardiovascular Retractor Aluminium

Code

DA-1454-00

CARDIOVASCULAR RETRACTOR

Cooley Cardiovascular Retractor Aluminium



Dimensional Diagram

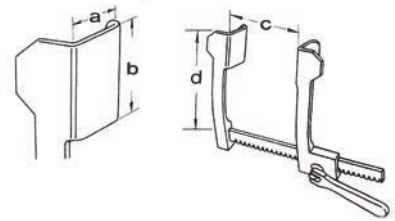

Blade Size

Total Spread

Cooley
Neonatal size.
Aluminium natural grey.

A	B	C	D
14 mm	16 mm	85 mm	55 mm

Description

Cooley Cardiovascular Retractor Aluminium

Code

DA-1455-00

Cooley Cardiovascular Retractor Aluminium



Dimensional Diagram

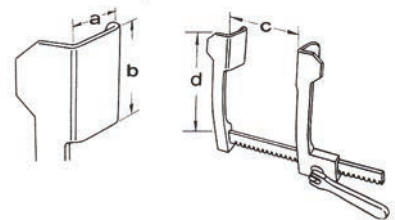

Blade Size

Total Spread

Cooley
Infant size, Sternal spreader.
Aluminium natural grey.

A	B	C	D
15 mm	20 mm	100 mm	80 mm

Description

Cooley Cardiovascular Retractor Aluminium

Code

DA-1456-00

Skill-Ankeney Cardiovascular Retractor Aluminium

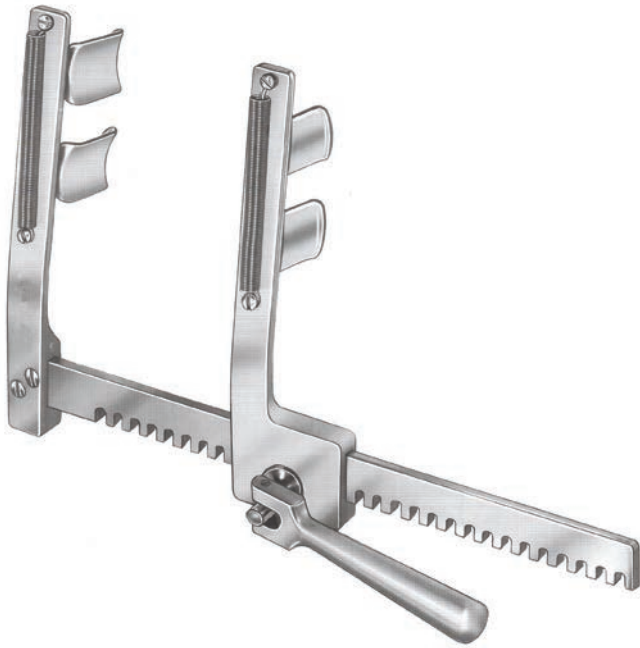

Dimensional Diagram

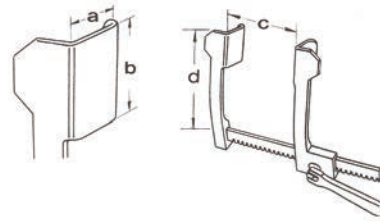

Blade Size

Total Spread

Skill-Ankeney

Child size, with double swivel blades, distance blades 30 mm, suture separator Aluminium natural grey.

A	B	C	D
20 mm	20 mm	160 mm	115 mm

Description

Skill-Ankeney Cardiovascular Retractor Aluminium

Code

DA-1457-00

Cooley Cardiovascular Retractor Aluminium



Dimensional Diagram

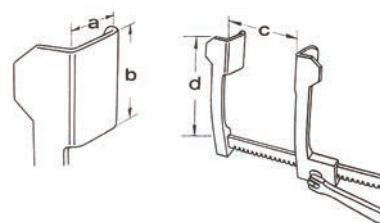

Blade Size

Total Spread

Cooley

For adults, standard size, modified by Skill. Aluminium natural grey.

A	B	C	D
30 mm	50 mm	185 mm	145 mm

Description

Cooley Cardiovascular Retractor Aluminium

Code

DA-1458-00

CARDIOVASCULAR RETRACTOR

Cooley Cardiovascular Retractor Aluminium



Dimensional Diagram

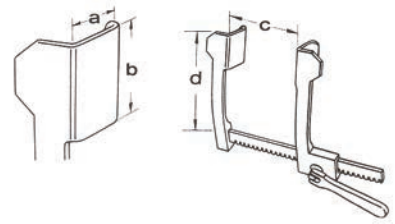

Blade Size

Total Spread

Cooley

For children, modified by Skill.
Aluminium natural grey.

A	B	C	D
20 mm	45 mm	140 mm	110 mm

Description

Cooley Cardiovascular Retractor Aluminium

Code

DA-1459-00

Cooley Cardiovascular Retractor Aluminium



Dimensional Diagram

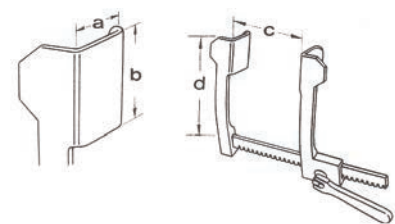

Blade Size

Total Spread

Cooley

Adult size, modified by Skill.
Aluminium natural grey.

A	B	C	D
35 mm	100 mm	180 mm	180 mm

Description

Cooley Cardiovascular Retractor Aluminium

Code

DA-1460-00

Cooley Cardiovascular Retractor Aluminium



Dimensional Diagram

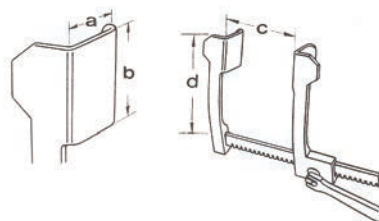

Blade Size

Total Spread

Cooley
Adult size, suture separator, modified by Skill.
Aluminium natural grey.

A	B	C	D
35 mm	100 mm	180 mm	180 mm

Description

Cooley Cardiovascular Retractor Aluminium

Code

DA-1461-00

Cooley Cardiovascular Retractor Aluminium



Dimensional Diagram

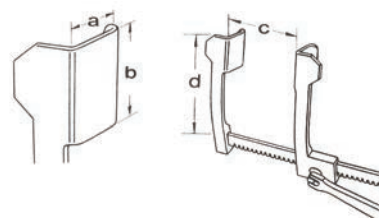

Blade Size

Total Spread

Cooley
Extra large, adult size.
Aluminium natural grey.

A	B	C	D
35 mm	115 mm	230 mm	205 mm

Description

Cooley Cardiovascular Retractor Aluminium

Code

DA-1462-00

CARDIOVASCULAR RETRACTOR

Cooley Cardiovascular Retractor Aluminium



Dimensional Diagram

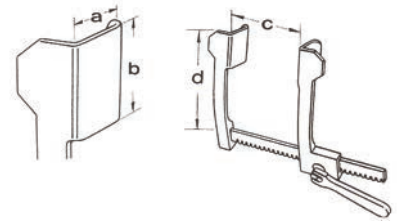

Blade Size

Total Spread

Cooley
Neonatal.
Aluminium natural grey.

A	B	C	D
12 mm	15 mm	70 mm	55 mm

Description

Cooley Cardiovascular Retractor Aluminium

Code

DA-1463-00

Weinberg Cardiovascular Retractor Aluminium



Dimensional Diagram

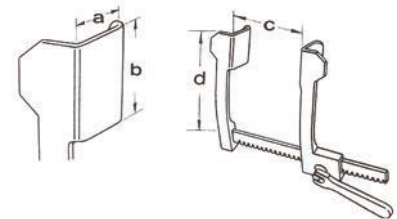

Blade Size

Total Spread

Weinberg
For children, modified by Skill.
Aluminium natural grey.

A	B	C	D
12 mm	20 mm	95 mm	75 mm

Description

Weinberg Cardiovascular Retractor Aluminium

Code

DA-1464-00

Cooley Cardiovascular Retractor Aluminium



Dimensional Diagram

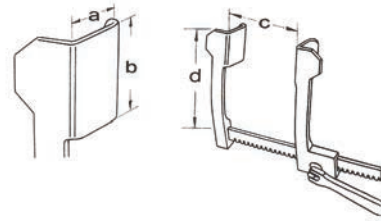

Blade Size

Total Spread

Cooley
Child size.
Aluminium natural grey.

A	B	C	D
20 mm	25 mm	100 mm	80 mm

Description

Cooley Cardiovascular Retractor Aluminium

Code

DA-1465-00

Cooley Cardiovascular Retractor Aluminium

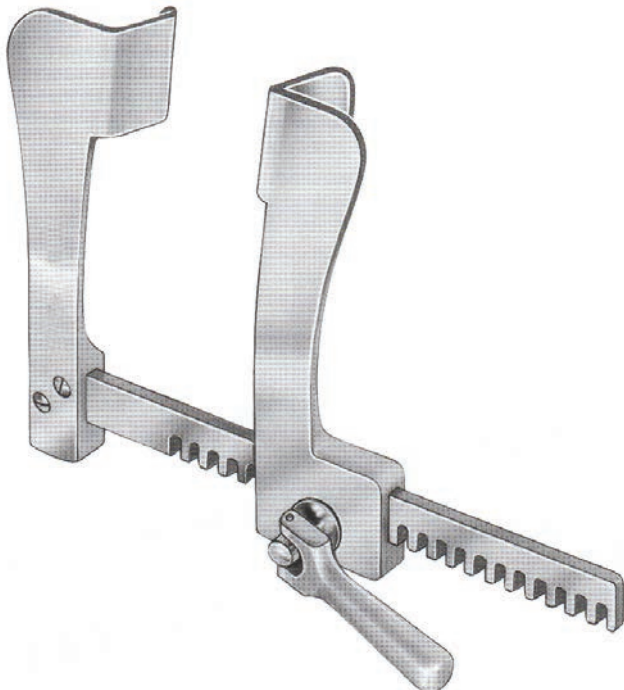

Dimensional Diagram

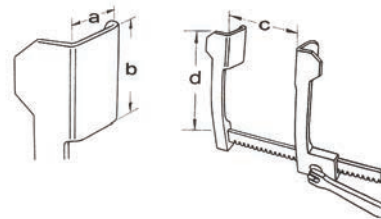

Blade Size

Total Spread

Cooley
For babies.
Aluminium natural grey.

A	B	C	D
20 mm	25 mm	100 mm	80 mm

Description

Cooley Cardiovascular Retractor Aluminium

Code

DA-1466-00

CARDIOVASCULAR RETRACTOR

Braastad Cardiovascular Retractor Aluminium

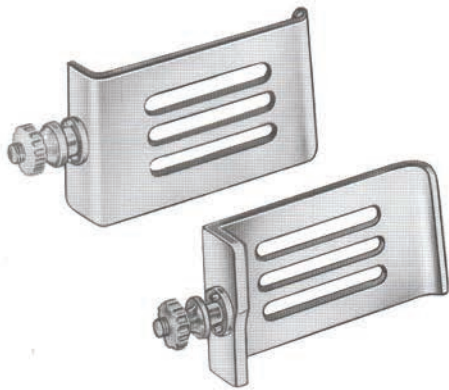

Dimensional Diagram

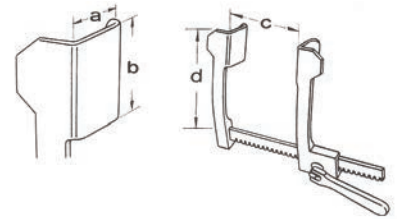

Blade Size

Total Spread

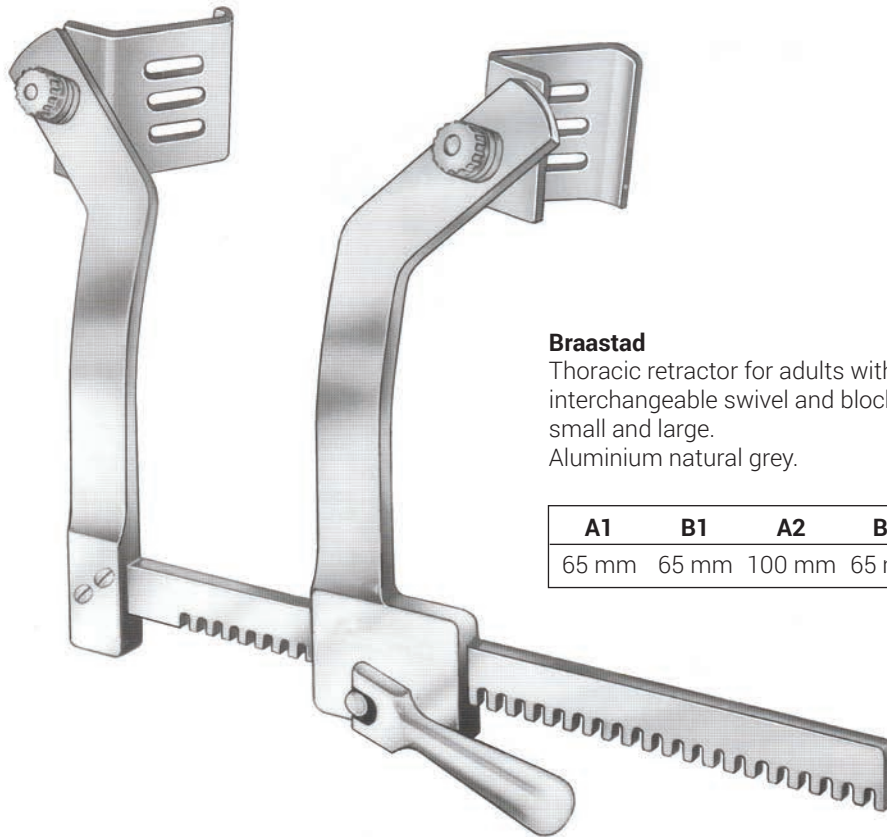

Braastad

Thoracic retractor for adults with two pairs of interchangeable swivel and blockable blades, small and large. Aluminium natural grey.

A1	B1	A2	B2	C	D
65 mm	65 mm	100 mm	65 mm	330 mm	210 mm

Pair of Blades

A	B
65 mm	65 mm
100 mm	65 mm

Description

Braastad Cardiovascular Retractor Aluminium

Braastad Cardiovascular Retractor Aluminium Pair of Blades 65 mm x 65 mm

Braastad Cardiovascular Retractor Aluminium Pair of Blades 100 mm x 65 mm

Code

DA-1467-00

DA-1468-00

DA-1469-00

Struck Cardiovascular Retractor Stainless Steel



Dimensional Diagram

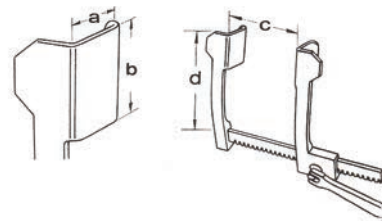

Blade Size

Total Spread

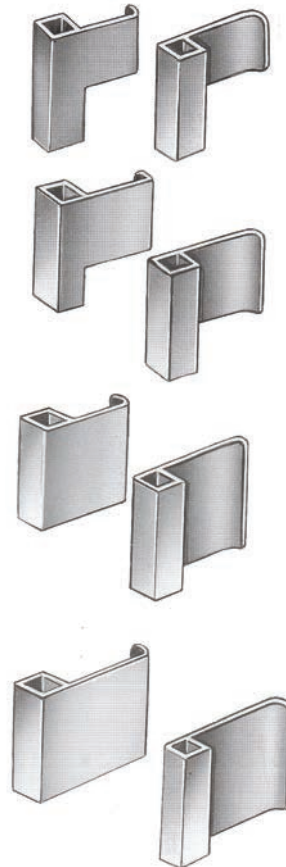

Struck

Infant size with two pairs of detachable blades, small and large.

A1	B1	A2	B2	C	D
15 mm	20 mm	20 mm	20 mm	70 mm	55 mm

A	B
15 mm	20 mm
20 mm	20 mm
10 mm	20 mm
10 mm	15 mm

Description

Struck Cardiovascular Retractor Stainless Steel

Struck Cardiovascular Retractor Stainless Steel Pair of Blades 15 mm x 20 mm

Struck Cardiovascular Retractor Stainless Steel Pair of Blades 20 mm x 20 mm

Struck Cardiovascular Retractor Stainless Steel Pair of Blades 10 mm x 20 mm

Struck Cardiovascular Retractor Stainless Steel Pair of Blades 10 mm x 15 mm

Code

DA-1470-00

DA-1471-00

DA-1472-00

DA-1473-00

DA-1474-00

CARDIOVASCULAR RETRACTOR

Cooley Cardiovascular Retractor Stainless Steel



Dimensional Diagram

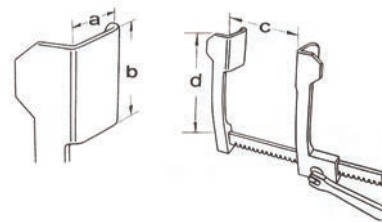

Blade Size

Total Spread

Cooley

Adult size, extra large with stable concave-convex blades.

A	B	C	D
35 mm	110 mm	230 mm	205 mm

Cooley

For adults, standard size, modified by Skill.

A	B	C	D
35 mm	100 mm	180 mm	165 mm

Description

Cooley Cardiovascular Retractor Stainless Steel Adult Size

Cooley Cardiovascular Retractor Stainless Steel Standard Size

Code

DA-1475-00

DA-1476-00

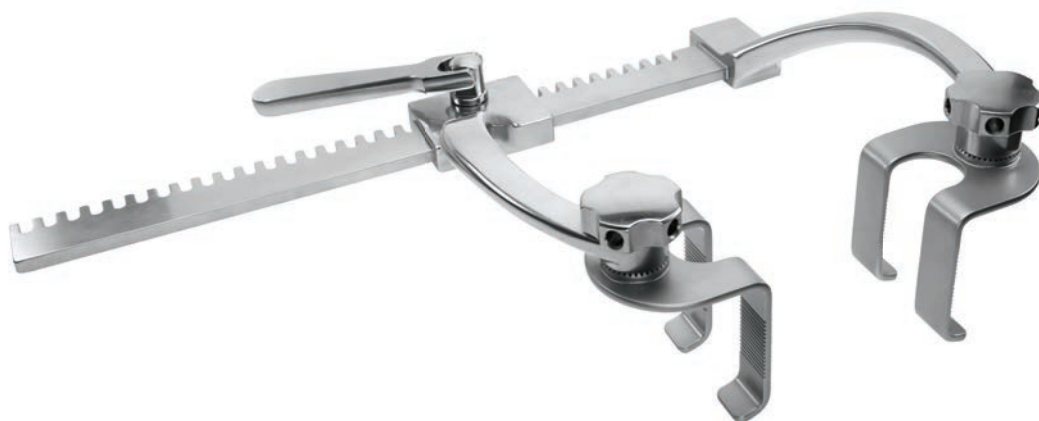

Skill-DeBakey Cardiovascular Retractor Stainless Steel

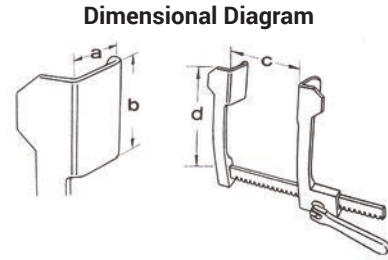

Blade Size

Total Spread

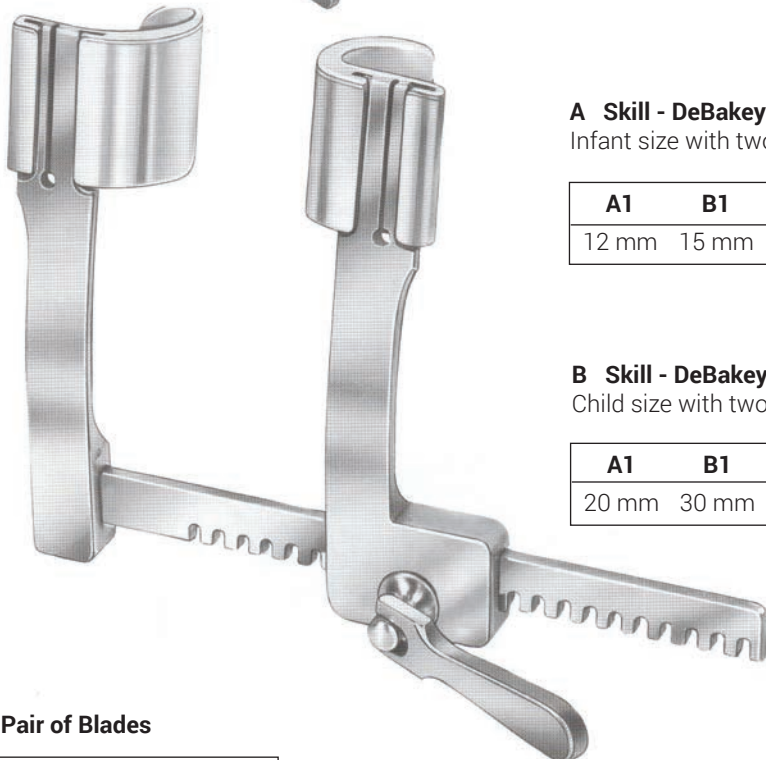

A Skill - DeBakey

Infant size with two pairs of interchangeable blades.

A1	B1	A2	B2	C	D
12 mm	15 mm	15 mm	15 mm	70 mm	90 mm

B Skill - DeBakey

Child size with two pairs of interchangeable blades.

A1	B1	A2	B2	C	D
20 mm	30 mm	30 mm	30 mm	120 mm	130 mm

Pair of Blades

A	B
12 mm	15 mm
15 mm	15 mm
20 mm	30 mm
30 mm	30 mm
30 mm	60 mm
48 mm	60 mm

C Skill - DeBakey

Adult size with two pairs of interchangeable blades.

A1	B1	A2	B2	C	D
30 mm	60 mm	48 mm	60 mm	200 mm	190 mm

Description

A Skill - DeBakey Cardiovascular Retractor Stainless Steel

B Skill - DeBakey Cardiovascular Retractor Stainless Steel

C Skill - DeBakey Cardiovascular Retractor Stainless Steel

Skill - DeBakey Cardiovascular Retractor Aluminium Pair of Blades 12 mm x 15 mm

Skill - DeBakey Cardiovascular Retractor Aluminium Pair of Blades 15 mm x 15 mm

Skill - DeBakey Cardiovascular Retractor Aluminium Pair of Blades 20 mm x 30 mm

Skill - DeBakey Cardiovascular Retractor Aluminium Pair of Blades 30 mm x 30 mm

Skill - DeBakey Cardiovascular Retractor Aluminium Pair of Blades 30 mm x 60 mm

Skill - DeBakey Cardiovascular Retractor Aluminium Pair of Blades 48 mm x 60 mm

Code

DA-1477-00A

DA-1477-00B

DA-1477-00C

DA-1478-00

DA-1479-00

DA-1480-00

DA-1481-00

DA-1482-00

DA-1483-00

CARDIOVASCULAR RETRACTOR

DuBost IMA Cardiovascular Retractor Stainless Steel

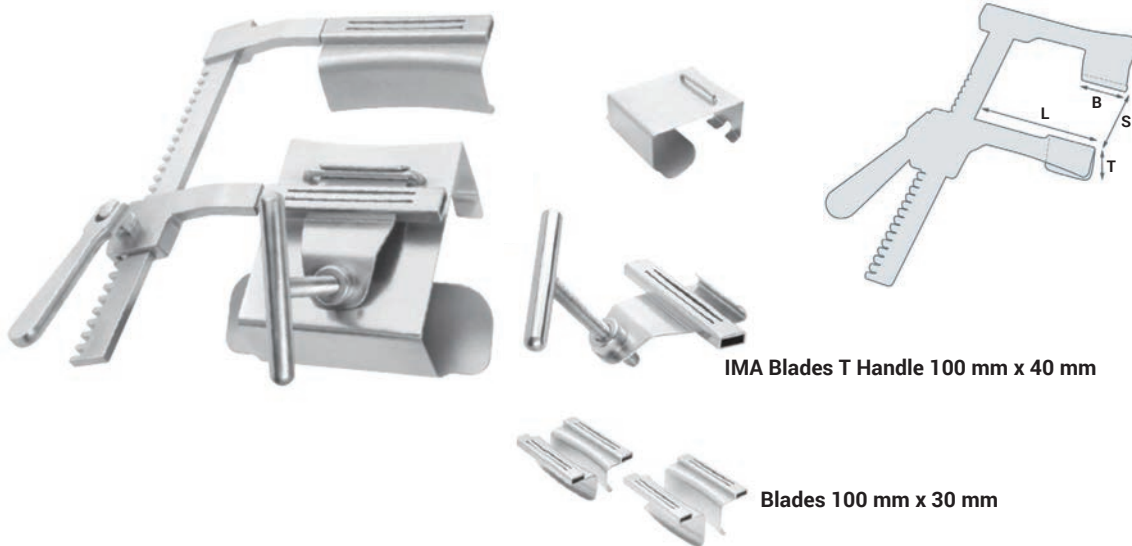

T	B	L	S
50 mm	100 mm	140 mm	160 mm

DuBost Retractor

Code

DA-1259-00

IMA Cardiovascular Retractor Stainless Steel

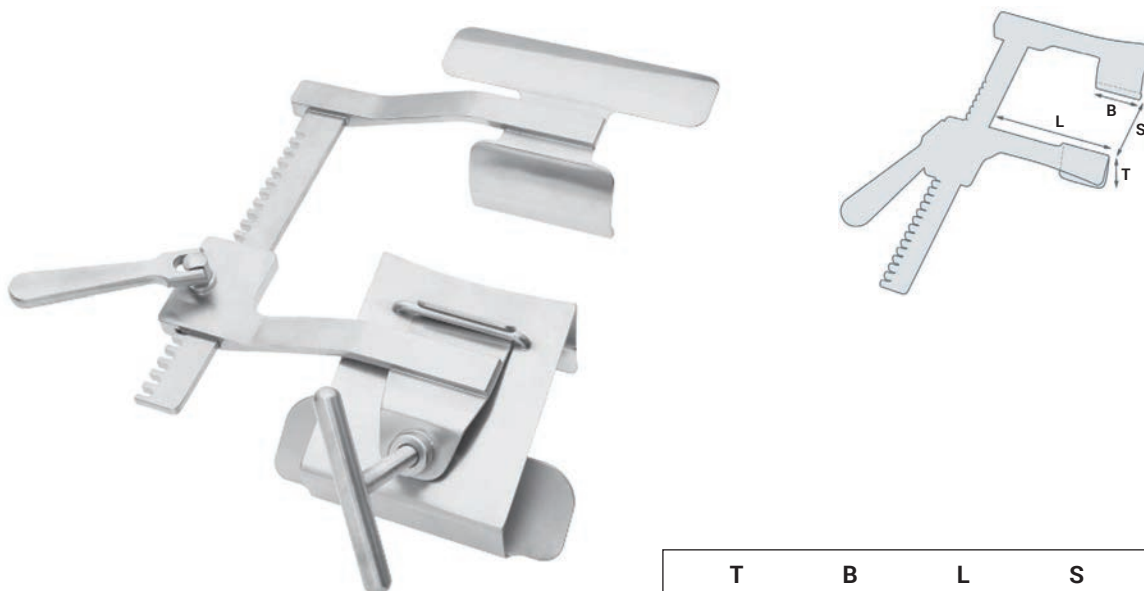

T	B	L	S
50 mm	150 mm	195 mm	134 mm

IMA Retractor

Code

DA-1260-00

IMA Cardiovascular Retractor Swivel Blades Stainless Steel



- 2 x Cooley Small Blades 25 mm
- 1 x Cooley Medium Blades 40 mm
- 1 x Cooley Large Blades 50 mm
- 2 x Malleable Ribbon Blades

IMA Retractor Complete set

Code

DA-1261-00

CARDIOVASCULAR RETRACTOR

CARDIOVASCULAR RETRACTOR

Cardibase Retractor System



Description

Cardibase Retractor Frame with 2 Inserts and
2 x Cooley Blades 30 mm x 100 mm x 190 mm x 190 mm

Code

CB1-10-9325-12

Snap in Coupling for attachments



Description

Snap in Coupling for attachments

Code

CB1-10-9325-10

Morse Blades

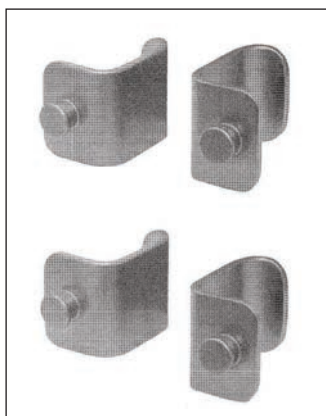

Description

4 x Morse Blades 30 mm x 28 mm

4 x Morse Blades 40 mm x 28 mm

Code

CB1-10-9325-30M

CB1-10-9325-40M

Cooley Blades

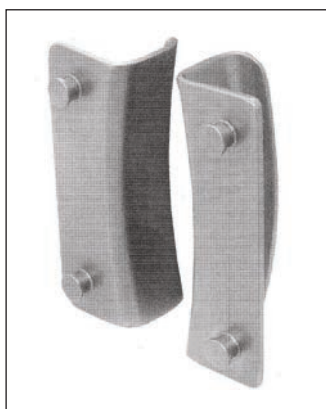

Description

2 x Cooley Blades 30 mm x 100 mm

2 x Cooley Blades 40 mm x 100 mm

Code

CB1-10-9325-30C

CB1-10-9325-40C

Malleable Hooks



Cooley

Malleable
Hook ShortMalleable
Hook LongMalleable
Hook Curved

Description	Dimension	Code
Cooley Malleable Rake Hook	20 mm	CB1-10-9325-20
Cooley Malleable Rake Hook	35 mm	CB1-10-9325-35
Cooley Malleable Rake Hook	45 mm	CB1-10-9325-45
Malleable Hook Short 14 cm	18 x 52 mm	CB1-10-9325-18S
Malleable Hook Short 14 cm	18 x 80 mm	CB1-10-9325-19S
Malleable Hook Short 14 cm	22 x 80 mm	CB1-10-9325-20S
Malleable Hook Long 19 cm	18 x 52 mm	CB1-10-9325-21S
Malleable Hook Long 19 cm	18 x 80 mm	CB1-10-9325-22S
Malleable Hook Long 19 cm	22 x 80 mm	CB1-10-9325-23S
Malleable Hook Long Curved 19 cm	18 x 52 mm	CB1-10-9325-24S
Malleable Hook Long Curved 19 cm	18 x 80 mm	CB1-10-9325-25S
Malleable Hook Long Curved 19 cm	22 x 80 mm	CB1-10-9325-26S

Ross Retractor Serrated Cardiobase Retractor

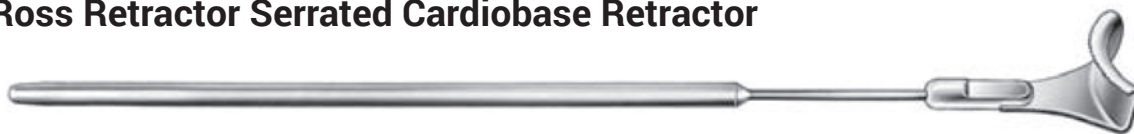

Description	Dimension	Code
Ross Retractor serrated, 25 cm, Small	16 x 16 mm	CB1-10-9325-60
Ross Retractor serrated, 25 cm, Medium	24 x 14 mm	CB1-10-9325-61
Ross Retractor serrated, 25 cm, Large	24 x 17 mm	CB1-10-9325-62

Marberger Retractor Cardiobase Retractor



Description	Dimension	Code
Marberger Retractor, 24 cm, Small	17 mm	CB1-10-9325-63
Marberger Retractor, 24 cm, Medium	20 mm	CB1-10-9325-64
Marberger Retractor, 24 cm, Large	23 mm	CB1-10-9325-65

Cooley-type Rake Retractor Malleable Cardiobase Retractor



Description	Dimension	Code
Cooley-type Rake Retractor Malleable 26 cm, Small	20 mm	CB1-10-9325-66
Cooley-type Rake Retractor Malleable 26 cm, Medium	35 mm	CB1-10-9325-67
Cooley-type Rake Retractor Malleable 26 cm, Large	45 mm	CB1-10-9325-68

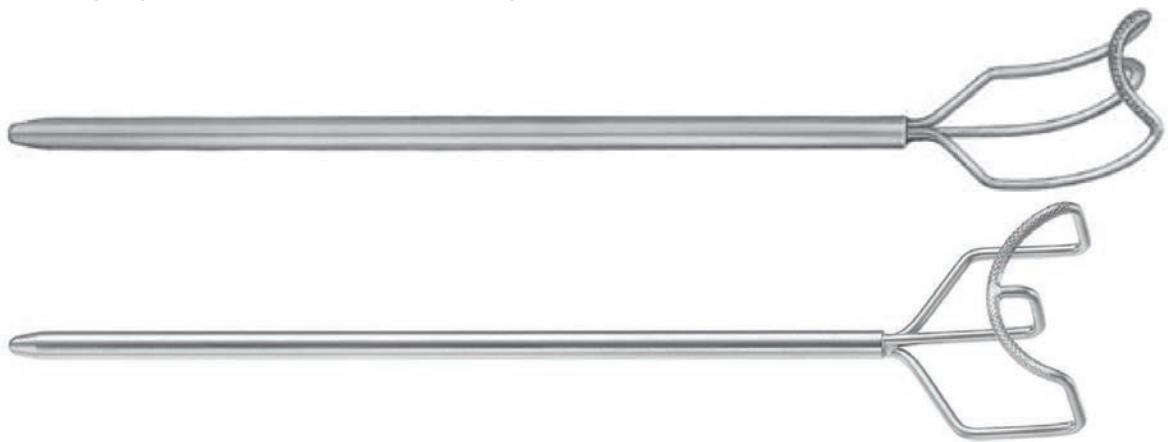

Cooley-type Rake Retractor Rigid Cardiobase Retractor

Description	Dimension	Code
Cooley-type Rake Retractor Rigid, 24 cm, Small	20 mm	CB1-10-708-20
Cooley-type Rake Retractor Rigid, 24 cm, Medium	35 mm	CB1-10-708-35
Cooley-type Rake Retractor Rigid, 24 cm, Tricuspid	45 mm	CB1-10-708-45
Cooley-type Rake Retractor Rigid, 24 cm, Large	45 mm	CB1-10-708-45*

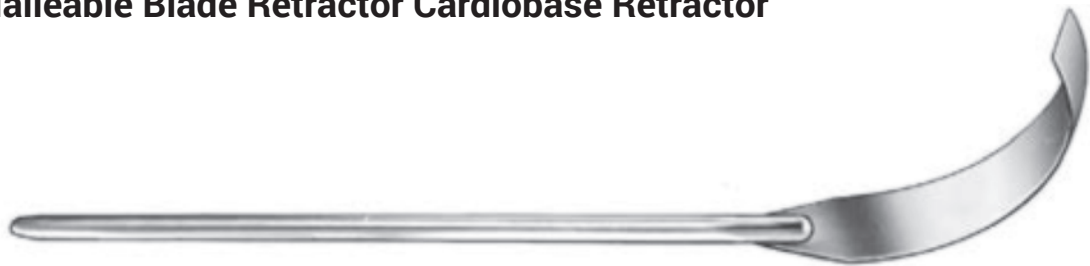
Malleable Blade Retractor Cardiobase Retractor

Description	Code
Malleable Blade Retractor, 26 cm	CB1-10-708-24

Malleable Illumination Arm Cardiobase Retractor

Description	Code
Fits onto almost all available Rib Spreaders	CB1-10-708-00

Removable Blades IMA Retractor System

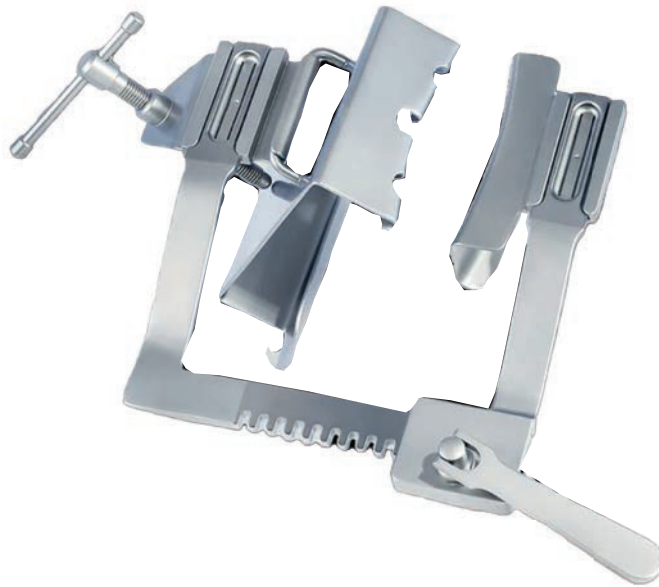

Blades

IMA Blades Long Screw Connection



Description

Retractor 40 mm x 100 mm x 230 mm x 160 mm

Retractor 50 mm x 60 mm x 230 mm x 160 mm

Set Blades 30 mm x 100 mm

Set Blades 50 mm x 100 mm

Set Blades 60 mm x 100 mm

Set Blades 35 mm x 42 mm

IMA Blade Long Screw Connection

IMA Blade Short with Teeth

Code

CB1-10-5430-01

CB1-10-5430-02

CB1-10-5430-03/30

CB1-10-5430-04/50

CB1-10-5430-04/60

CB1-10-5430-05

CB1-10-5430-06

CB1-10-5430-07

Cooley Mitral Retractor System



Description	Spreading width	Arm length	Code
Cooley Mitral Frame, XXL	205 mm	230 mm	CB1-10-708-42
Side Arm Bar, Blades Retractor attachment, diam: 6 mm			CB1-10-708-45
Main Clamp Blades Retractor attachment, diam: 6 mm			CB1-10-708-50

Description	Width	Depth	Code
Cooley Blades Small, Curved	28 mm	35 mm	CB1-10-709-05
Cooley Blades Medium, Curved	38 mm	35 mm	CB1-10-709-15
Cooley Blades Flat	42 mm	22 mm	CB1-10-709-20

Cooley Mitral Retractor System



Description	Spreading width	Arm length	Code
Cooley Mitral Frame XL	180 mm	180 mm	CB1-10-708-41

Description	Width	Depth	Code
Cooley Atrial Retractor Blades, Small	25 mm	35 mm	CB1-10-708-60*
Cooley Atrial Retractor Blades	40 mm	35 mm	CB1-10-708-65*
Cooley Atrial Retractor Blades, Large	50 mm	35 mm	CB1-10-708-70*
Cooley Atrial Retractor Blades, Tricuspid	50 mm	20 mm	CB1-10-708-75*
Atrial Retractor, Large	50 mm	35 mm	CB1-10-729-45
Atrial Retractor, Large, Low Profile	50 mm	20 mm	CB1-10-729-48
Ribbon Blades Retractor	25 mm	76 mm	CB1-10-729-50
Ribbon Blades Retractor	19 mm	76 mm	CB1-10-729-52
Ribbon Blades Retractor	13 mm	76 mm	CB1-10-729-55
Cooley Small Blades	25 mm	35 mm	CB1-10-729-35
Cooley Blades Medium, Slightly Curved	38 mm	48 mm	CB1-10-709-10
Cooley Medium Blades	38 mm	35 mm	CB1-10-729-40
Cooley Blades Small, Curved	28 mm	35 mm	CB1-10-709-25*
Cooley Blades Medium, Slightly Curved	38 mm	48 mm	CB1-10-709-30*
Cooley Blades Medium, Curved	38 mm	35 mm	CB1-10-709-35*
Cooley Blades Flat	42 mm	22 mm	CB1-10-709-40*

CARDIOVASCULAR RETRACTOR

IMA Couetil Retractor**Description**

IMA Couetil Retractor 150 mm X 150 mm

1 x Long Blade 100 mm

2 x French Hook 40 mm x 22 mm

2 x French Hook 50 mm x 22 mm

Code

CB1-10-725-05

CB1-10-725-06

CB1-10-725-07

CB1-10-725-08



IMA Retractor System



Description

- 1 x Frame with Arms
- 1 x Fixation T Rack
- 1 x Fixation Blades
- 1 x T Clamps
- 2 x Universal Clamps
- 2 x Small Cooley Blades 25 mm
- 1 x Medium Cooley Blades 40 mm
- 1 x Large Cooley Blades 50 mm
- 2 x Ribbon Malleable Blades Retractor

Code

- CB1-10-729-04
- CB1-10-729-07
- CB1-10-729-09
- CB1-10-729-15
- CB1-10-729-30
- CB1-10-729-35
- CB1-10-729-40
- CB1-10-729-50
- CB1-10-729-55

CARDIOVASCULAR RETRACTOR

Carpentier Mitral Valve Retractors

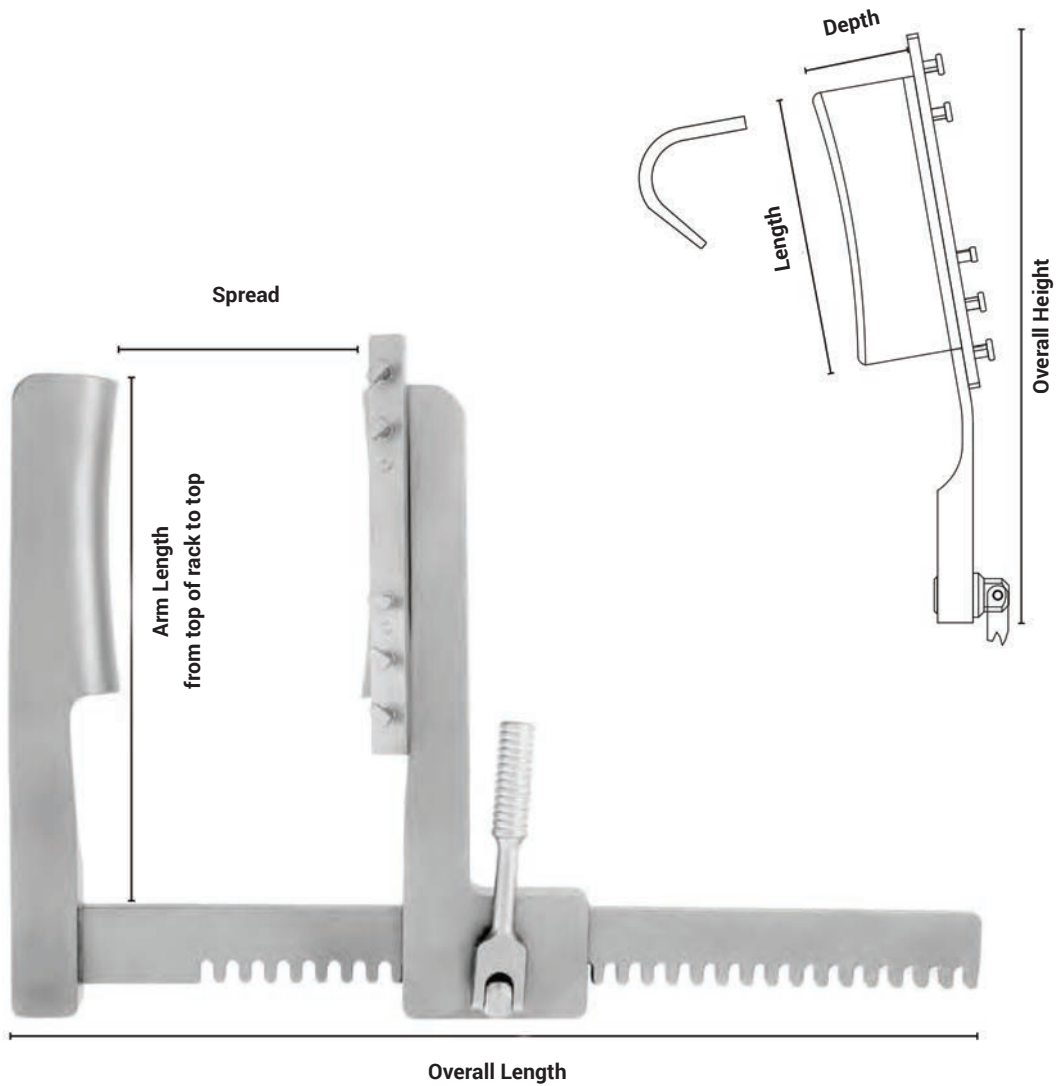

Description	Overall Length mm	Overall Length mm	Arm Length from top of rack to top mm	Blade Length mm	Blade Depth mm	Blade Width mm	Max. Spread mm	Code
Carpentier Mitral Valve Thorax Spreader	306	215	165	100	36	38	200	CB1-10-3023-00
Description								Code
Retractor Frame, 2 Sternal Blades								CB1-10-3027-00
Retractor Frame, 2 Sternal Blades								CB1-10-3028-00
Description								Code
Set								CB1-10-3023-00

Carpentier Mitral Valve Retractors

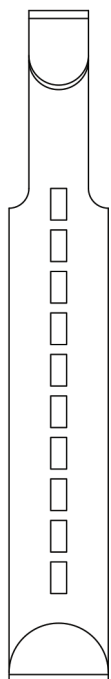

Description	Length	Code
Sternal Blades for Carpentier Thorax Spreader	15/25 mm	CB1-10-3027-00

Description	Length	Code
Sternal Blades for Carpentier Thorax Spreader	15/25 mm	CB1-10-3028 00

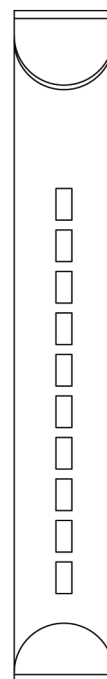

Thorax Lifting Retractor**Description**

Thorax Lifting Retractor Stable Rib Elevation
Plus Facilitates Harvesting, Excellent Exposure, Larger Operating Area,
Choice of 2 Lower Blades, Choice of 3 Upper Blades

Code

CB1-10-1180-00

French Model Mini IMA Retractor**Description**

Lifting Retractor, 37 mm x 12 mm x 180 mm x 150 mm

Code

CB1-10-1190-00

McCarthy Mini Sternotomy Retractor System

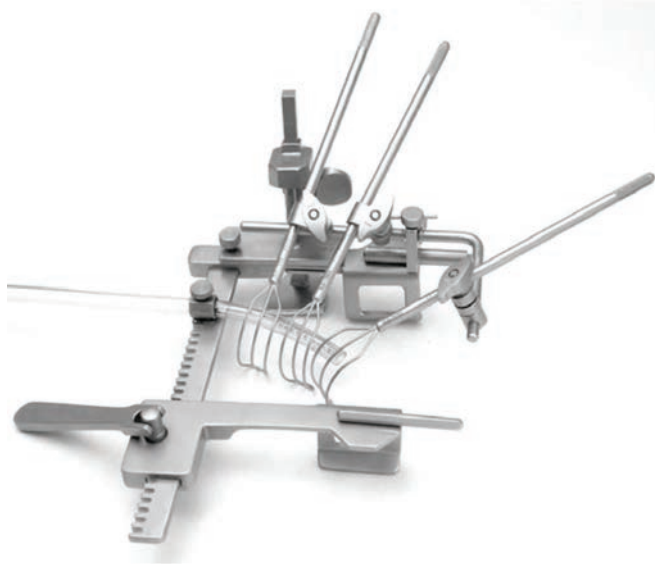

The Self-retaining Retractor was designed to provide excellent exposure for a variety of valve operations, maze procedure, or other intra cardiac procedures. It can also be used for mini sternotomy or coronary artery bypass operations or for mini sternotomy procedures depending on the patients size. The removable lift attachment allows for better exposure for valve procedures.

Description

Chest Spreader Finochietto Dual Bars
 Split Universal Clamp for attachments
 Universal Clamp for attachments
 Main Bracket

Code

CB1-10-2935-01
 CB1-10-2935-02
 CB1-10-2935-03
 CB1-10-2935-04



Sellors Rib Spreader Stainless Steel

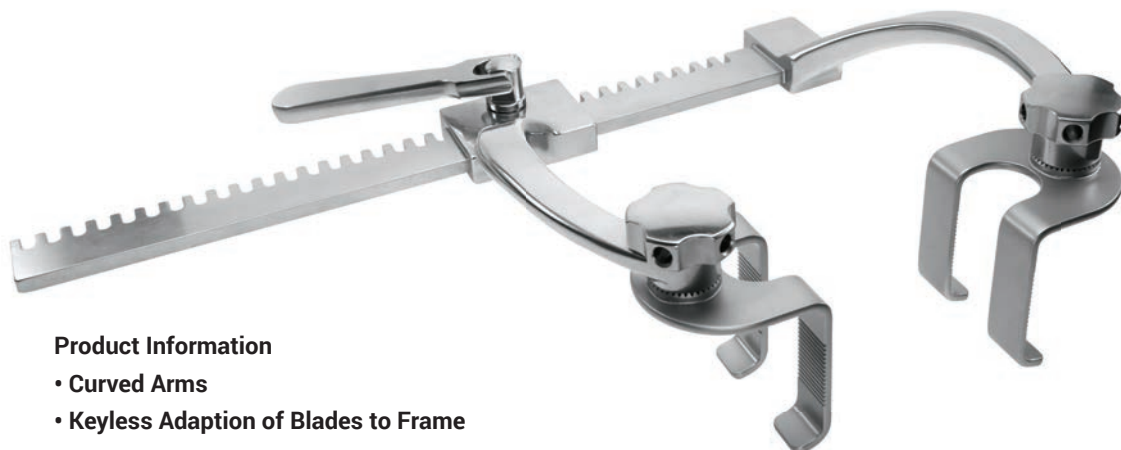

Product Information

- Curved Arms
- Keyless Adaption of Blades to Frame

Description	Code
Sellors Rib Spreader Stainless Steel	CB1-10-739-05

Consisting of:

Description	Spreading Width	Arm Length	Qty	Code
Sellors Frame	min. 197 mm	140 mm	1	CB1-10-739-10

Description	Width	Depth	Qty	Code
1 Pair of Blades	50 mm	40 mm	1	CB1-10-739-25
1 Pair of Blades	50 mm	50 mm	1	CB1-10-739-30
1 Pair of Blades	50 mm	70 mm	1	CB1-10-739-35

Options

Description	Width	Depth	Qty	Code
1 Pair of Blades	75 mm	30 mm	1	CB1-10-739-50
1 Pair of Blades	75 mm	45 mm	1	CB1-10-739-55
1 Pair of Blades	120 mm	30 mm	1	CB1-10-739-60
1 Pair of Blades	75 mm	78 mm	1	CB1-10-739-65

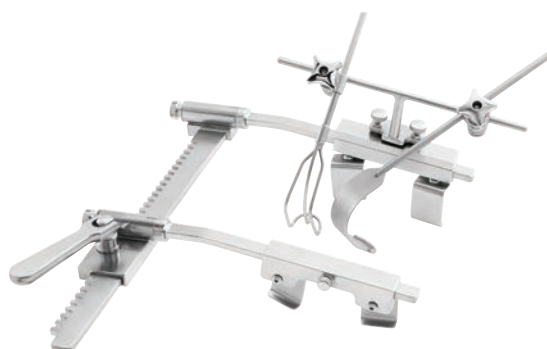

Volkman Retractor

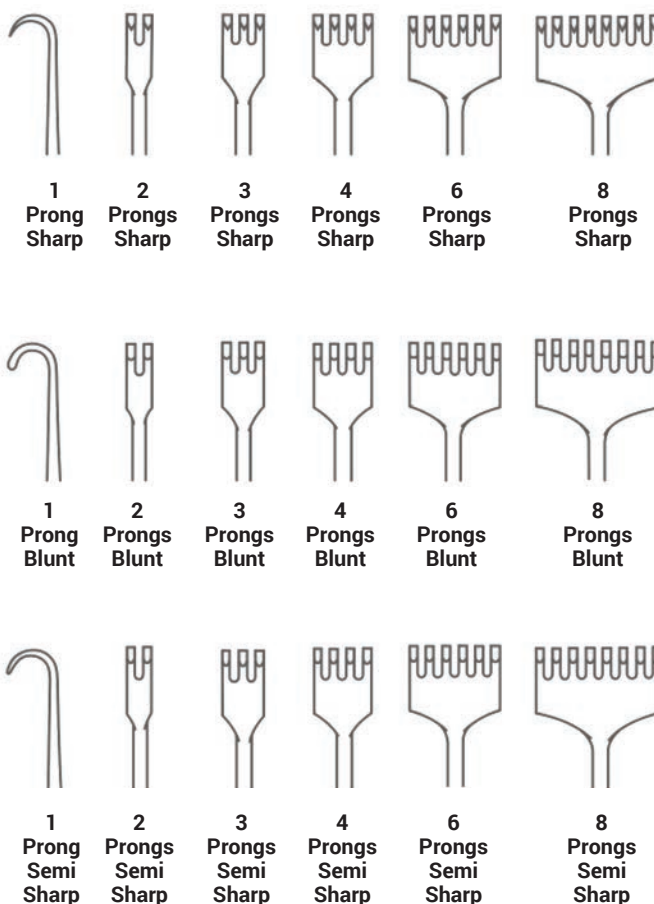

Description	Length	Code
Volkman Retractor 1 Prong Sharp	22 cm	BG-001-01
Volkman Retractor 1 Prong Semi-Sharp	22 cm	BG-001-02
Volkman Retractor 1 Prong Blunt	22 cm	BG-001-03
Volkman Retractor 2 Prongs Sharp	22 cm	BG-002-01
Volkman Retractor 2 Prongs Semi-Sharp	22 cm	BG-002-02
Volkman Retractor 2 Prongs Blunt	22 cm	BG-002-03
Volkman Retractor 3 Prongs Sharp	22 cm	BG-003-01
Volkman Retractor 3 Prongs Semi-Sharp	22 cm	BG-003-02
Volkman Retractor 3 Prongs Blunt	22 cm	BG-003-03
Volkman Retractor 4 Prongs Sharp	22 cm	BG-004-01
Volkman Retractor 4 Prongs Semi-Sharp	22 cm	BG-004-02
Volkman Retractor 4 Prongs Blunt	22 cm	BG-004-03
Volkman Retractor 5 Prongs Sharp	22 cm	BG-005-01
Volkman Retractor 5 Prongs Semi-Sharp	22 cm	BG-005-02
Volkman Retractor 5 Prongs Blunt	22 cm	BG-005-03
Volkman Retractor 6 Prongs Sharp	22 cm	BG-006-01
Volkman Retractor 6 Prongs Semi-Sharp	22 cm	BG-006-02
Volkman Retractor 6 Prongs Blunt	22 cm	BG-006-03
Volkman Retractor 8 Prongs Sharp	22 cm	BG-008-01
Volkman Retractor 8 Prongs Semi-Sharp	22 cm	BG-008-02
Volkman Retractor 8 Prongs Blunt	22 cm	BG-008-03

CARDIOVASCULAR RETRACTOR

Volkman Retractor

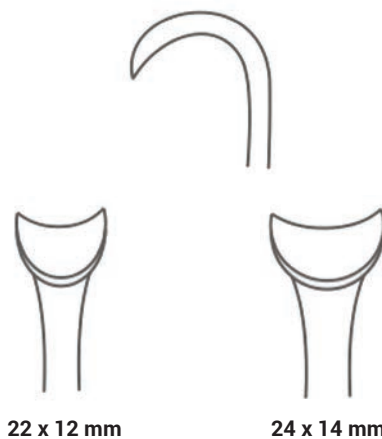

Description

Volkman Retractor 22 x 12 mm

Volkman Retractor 24 x 14 mm

Length

22 cm

22 cm

Code

BG-009-01

BG-009-02



Volkman Retractor



42 x 10 mm



42 x 15 mm



24 x 14 mm

Description	Length	Code
Volkman Retractor 42 x 10mm	22 cm	BG-009-03
Volkman Retractor 42 x 15mm	22 cm	BG-009-04
Volkman Retractor 43 x 20mm	22 cm	BG-009-05



CARDIOVASCULAR RETRACTOR

Koerte Retractor

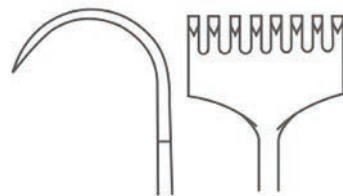

Sharp 8 Prongs

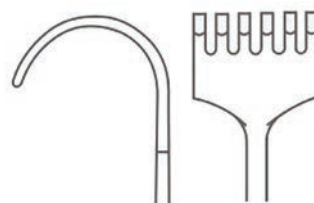

Blunt 6 Prongs

Description

Koerte Retractor 8 Prongs Sharp

Koerte Retractor 6 Prongs Blunt

Length

24 cm

24 cm

Code

BG-011-24

BG-012-24

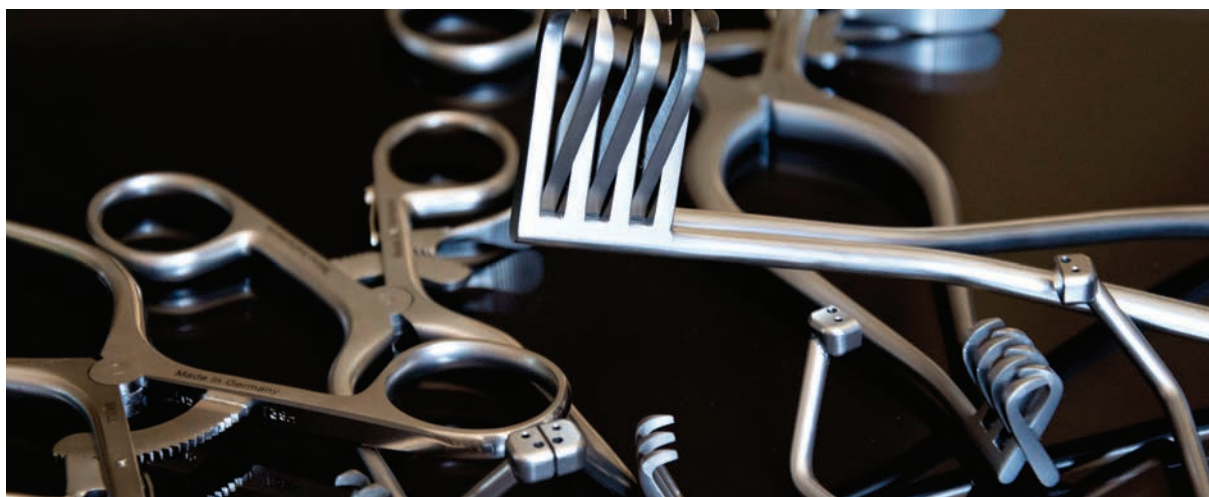

Israel Retractor



Blunt 4 Prongs
Blunt 5 Prongs
Blunt 6 Prongs
Blunt 7 Prongs

Description	Length	Code
Israel Retractor 4 Prongs Blunt	25 cm	BG-012-25
Israel Retractor 5 Prongs Blunt	25 cm	BG-013-25
Israel Retractor 6 Prongs Blunt	25 cm	BG-014-25
Israel Retractor 7 Prongs Blunt	25 cm	BG-015-25

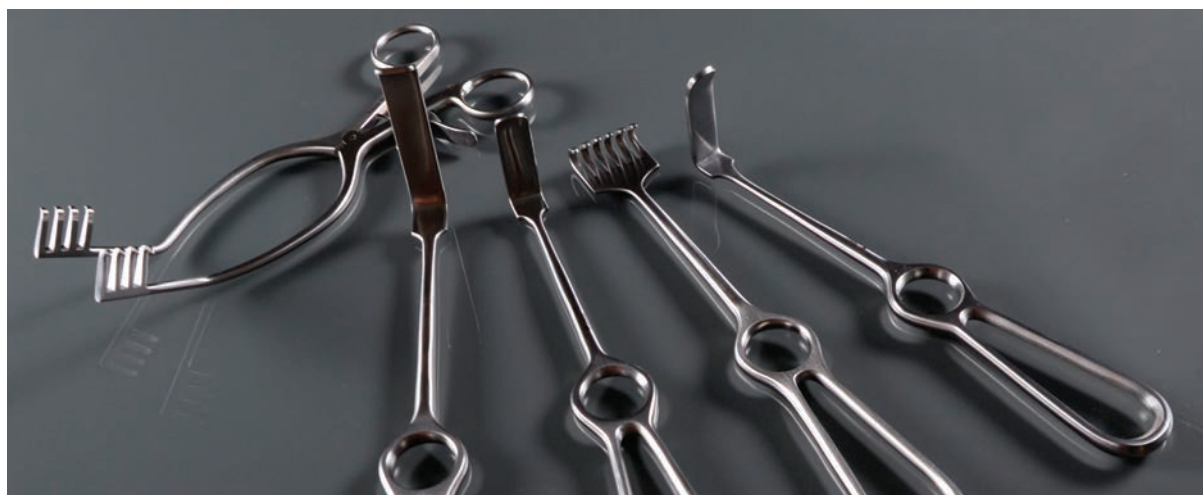

CARDIOVASCULAR RETRACTOR

Kocher Langenbeck Retractor

**Description**

Kocher Langenbeck 81 x 45 mm

Length

21 cm

Code

BG-025-11

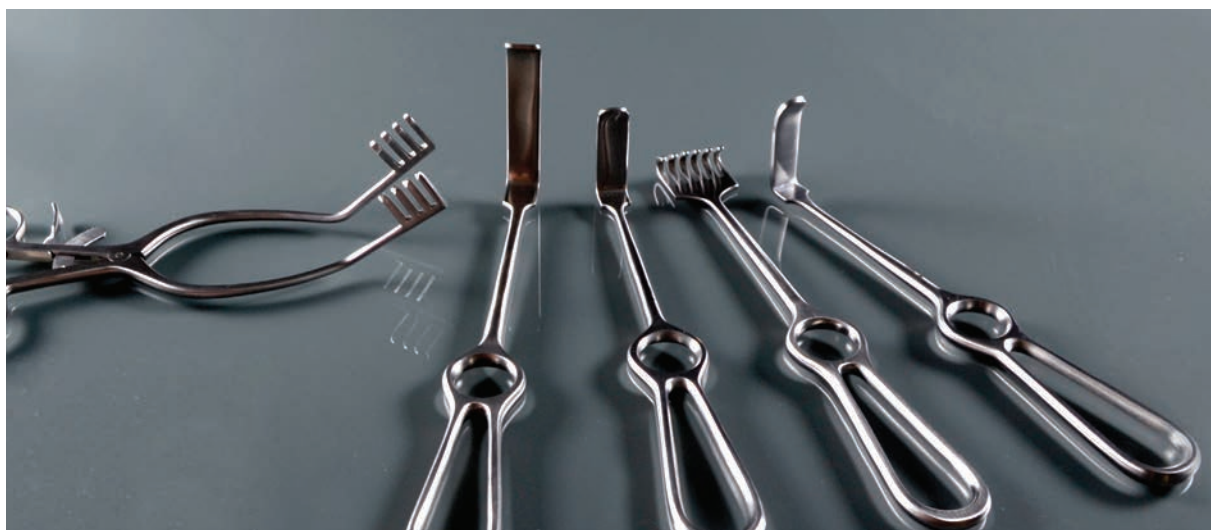

Jefferson Retractor

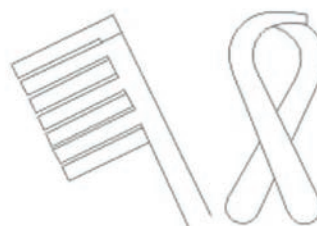

2 x 3 Blunt Prongs

Description

Jefferson Retractor 2 x 3 Teeth Blunt

Length

13 cm

Code

BG-023-13

Valve Retractor



Description

Valve Retractor Titanium Handle 5 mm

Length

18 cm

Code

BG-170-01

Valve Retractor Titanium Handle 7 mm

18 cm

BG-170-02

Valve Retractor Titanium Handle 9 mm

18 cm

BG-170-03

Valve Retractor Titanium Handle 10 mm

18 cm

BG-170-04

Valve Retractor Titanium Handle 11 mm

18 cm

BG-170-05

Valve Retractor Titanium Handle 13 mm

18 cm

BG-170-06

Valve Retractor Titanium Handle 15 mm

18 cm

BG-170-07

CARDIOVASCULAR RETRACTOR

Desmarres Open Lid Retractor



12 mm



14 mm



16 mm



18 mm

Description

Desmarres Open Lid Retractor 12 mm
 Desmarres Open Lid Retractor 14 mm
 Desmarres Open Lid Retractor 16 mm
 Desmarres Open Lid Retractor 18 mm

Length

16 cm
 16 cm
 16 cm
 16 cm

Code

BG-139-01
 BG-139-02
 BG-139-03
 BG-139-04



Desmarres Lid Retractor

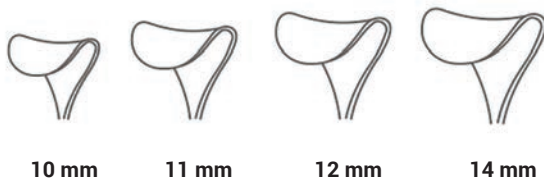
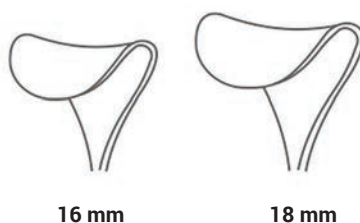
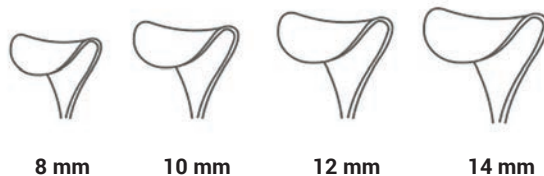

CARDIOVASCULAR RETRACTOR

Description

Length

Code

Desmarres Lid Retractor 8 mm	16 cm	BG-138-01
Desmarres Lid Retractor 10 mm	16 cm	BG-138-02
Desmarres Lid Retractor 12 mm	16 cm	BG-138-03
Desmarres Lid Retractor 14 mm	16 cm	BG-138-04
Desmarres Lid Retractor 16 mm	16 cm	BG-138-05
Desmarres Lid Retractor 18 mm	16 cm	BG-138-06
Desmarres Solid Blade Lid Retractor 10 mm	16 cm	BG-140-07S
Desmarres Solid Blade Lid Retractor 11 mm	16 cm	BG-140-08S
Desmarres Solid Blade Lid Retractor 12 mm	16 cm	BG-140-09S
Desmarres Solid Blade Lid Retractor 14 mm	16 cm	BG-140-10S

Ross Retractor

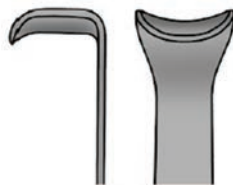

Fig. 1

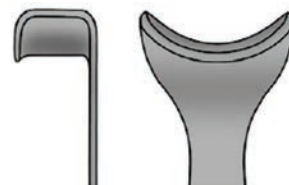

Fig. 2

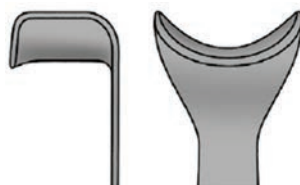

Fig. 3

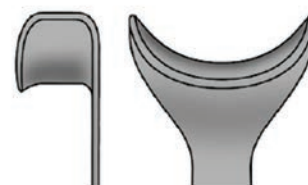

Fig. 4

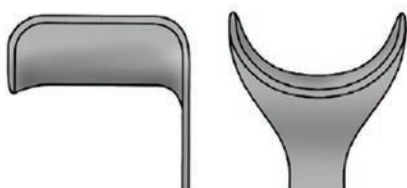

Fig. 5

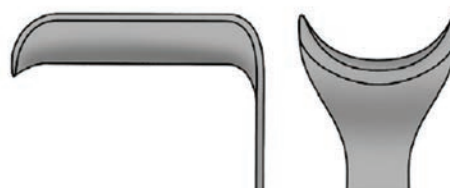

Fig. 6

Description

- Ross Retractor 16 x 15 mm
- Ross Retractor 23 x 13 mm
- Ross Retractor 25 x 18 mm
- Ross Retractor 29 x 13 mm
- Ross Retractor 29 x 29 mm
- Ross Retractor 21 x 35 mm

Length

- 26 cm
- 26 cm
- 26 cm
- 26 cm
- 26 cm
- 26 cm

Code

- BG-325-01
- BG-325-02
- BG-325-03
- BG-325-04
- BG-325-05
- BG-325-06



Cooley Atrium Retractor With Serrated Teeth



Description

Cooley Atrium Retractor With Serrated Teeth 25 mm x 35 mm Right
 Cooley Atrium Retractor With Serrated Teeth 40 mm x 35 mm Right
 Cooley Atrium Retractor With Serrated Teeth 50 mm x 35 mm Right
 Cooley Atrium Retractor With Serrated Teeth 50 mm x 10 mm Left

Length

21 cm
 21 cm
 21 cm
 21 cm

Code

DA-1300-01
 DA-1300-02
 DA-1300-03
 DA-1300-04

Davidson Scapula Retractor

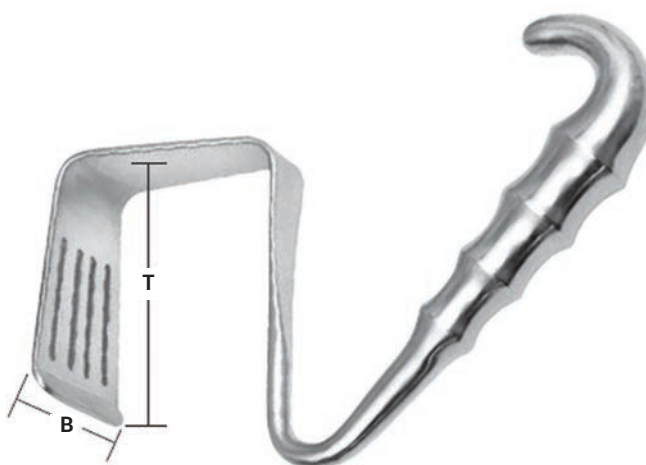

Description

Davidson Scapula Retractor 50 mm x 75 mm
 Davidson Scapula Retractor 90 mm x 75 mm

Length

20 cm
 20 cm

Code

DA-1305-01
 DA-1305-02

Copper Retractor Malleable



Description	Length	Code
Copper Retractor Malleable 4 mm	20 cm	BG-074-01
Copper Retractor Malleable 7 mm	20 cm	BG-074-02
Copper Retractor Malleable 10 mm	20 cm	BG-074-03
Copper Retractor Malleable 12 mm	20 cm	BG-074-04
Copper Retractor Malleable 15 mm	20 cm	BG-074-05
Copper Retractor Malleable 18 mm	20 cm	BG-074-06
Copper Retractor Malleable 20 mm	20 cm	BG-074-07
Copper Retractor Malleable 26 mm	20 cm	BG-074-08
Copper Retractor Malleable 30 mm	20 cm	BG-074-09
Copper Retractor Malleable 40 mm	20 cm	BG-074-10
Copper Retractor Malleable 50 mm	20 cm	BG-074-11

Description	Length	Code
Copper Retractor Malleable 4 mm	30 cm	BG-074-12
Copper Retractor Malleable 7 mm	30 cm	BG-074-13
Copper Retractor Malleable 10 mm	30 cm	BG-074-14
Copper Retractor Malleable 12 mm	30 cm	BG-074-15
Copper Retractor Malleable 15 mm	30 cm	BG-074-16
Copper Retractor Malleable 18 mm	30 cm	BG-074-17
Copper Retractor Malleable 20 mm	30 cm	BG-074-18
Copper Retractor Malleable 26 mm	30 cm	BG-074-19
Copper Retractor Malleable 30 mm	30 cm	BG-074-20
Copper Retractor Malleable 40 mm	30 cm	BG-074-21
Copper Retractor Malleable 50 mm	30 cm	BG-074-22



CARDIOVASCULAR RETRACTOR

Cushing Lid Retractor

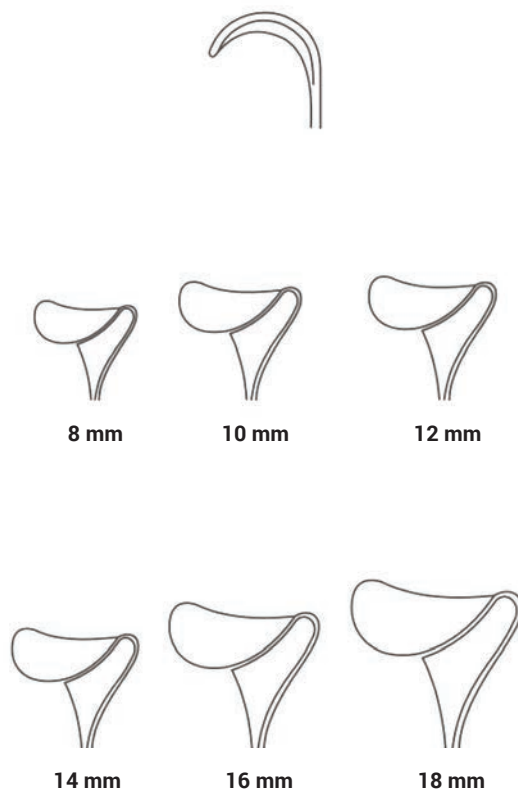

Description

- Cushing Lid Retractor 8 mm
- Cushing Lid Retractor 10 mm
- Cushing Lid Retractor 12 mm
- Cushing Lid Retractor 14 mm
- Cushing Lid Retractor 16 mm
- Cushing Lid Retractor 18 mm

Length

- 24 cm
- 24 cm
- 24 cm
- 24 cm
- 24 cm
- 24 cm

Code

- BG-146-01
- BG-146-02
- BG-146-03
- BG-146-04
- BG-146-05
- BG-146-06



Kirklin Lid Retractor

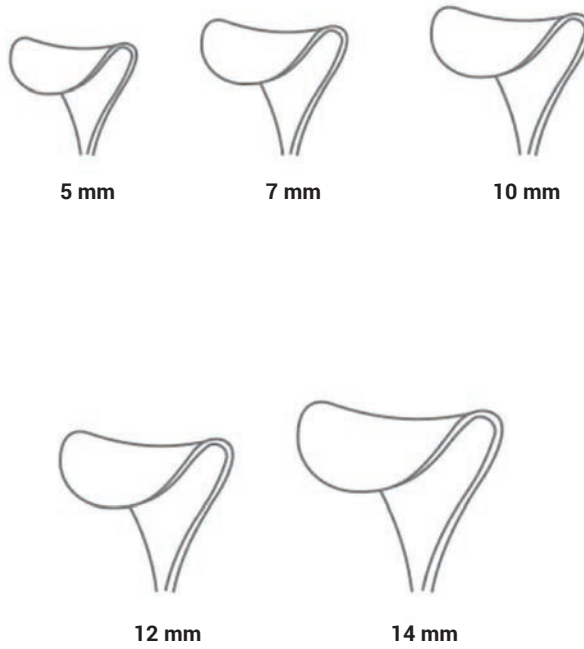

CARDIOVASCULAR RETRACTOR

Description

Kirklin Lid Retractor 5 mm
 Kirklin Lid Retractor 7 mm
 Kirklin Lid Retractor 10 mm
 Kirklin Lid Retractor 12 mm
 Kirklin Lid Retractor 14 mm

Length

14 cm
 14 cm
 14 cm
 14 cm
 14 cm

Code

BG-181-01
 BG-181-02
 BG-181-03
 BG-181-04
 BG-181-05

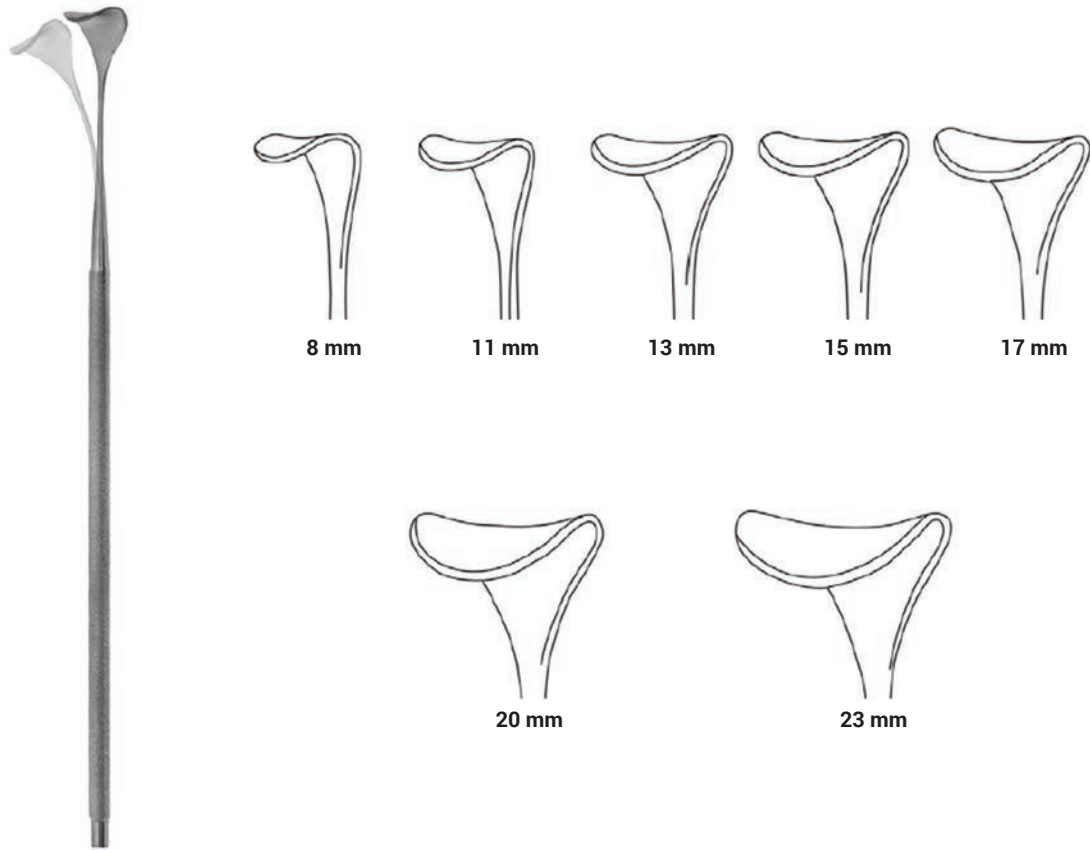

Gill-Vernet Malleable Retractor

**Description**

Gill-Vernet Malleable Retractor 4 mm
 Gill-Vernet Malleable Retractor 6 mm
 Gill-Vernet Malleable Retractor 8 mm
 Gill-Vernet Malleable Retractor 11 mm
 Gill-Vernet Malleable Retractor 13 mm
 Gill-Vernet Malleable Retractor 15 mm
 Gill-Vernet Malleable Retractor 17 mm
 Gill-Vernet Malleable Retractor 20 mm
 Gill-Vernet Malleable Retractor 23 mm

Length

24 cm
 24 cm
 24 cm
 24 cm
 24 cm
 24 cm
 24 cm
 24 cm
 24 cm

Code

BG-148-01
 BG-148-02
 BG-148-03
 BG-148-04
 BG-148-05
 BG-148-06
 BG-148-07
 BG-148-08
 BG-148-09



Murphy Retractor

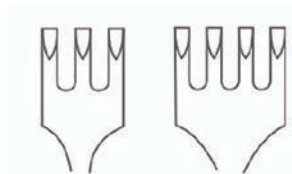

**Sharp
3 Prongs**

**Sharp
4 Prongs**

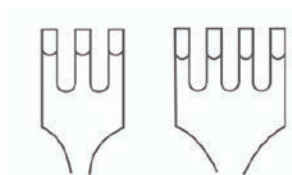

**Blunt
3 Prongs**

**Blunt
4 Prongs**

Description

- Murphy Retractor Sharp 3 Prongs
- Murphy Retractor Sharp 4 Prongs
- Murphy Retractor Blunt 3 Prongs
- Murphy Retractor Blunt 4 Prongs

Length

- 16 cm
- 16 cm
- 16 cm
- 16 cm

Code

- BG-149-01
- BG-149-02
- BG-149-03
- BG-149-04



Senn Miller Double Ended Retractor



22 x 7 mm



22 x 7 mm



18 x 6 mm

**Description**

Senn Miller Double Ended Retractor Sharp

Senn Miller Double Ended Retractor Blunt

Senn Miller Double Ended Retractor Sharp

Length

16 cm

16 cm

15 cm

Code

BG-150-01

BG-150-02

BG-150-03

Czerny Double Ended Retractor

**Description**

Czerny Double Ended Retractor

Length

20 cm

Code

BG-063-18

Kocher Langenbeck Retractor

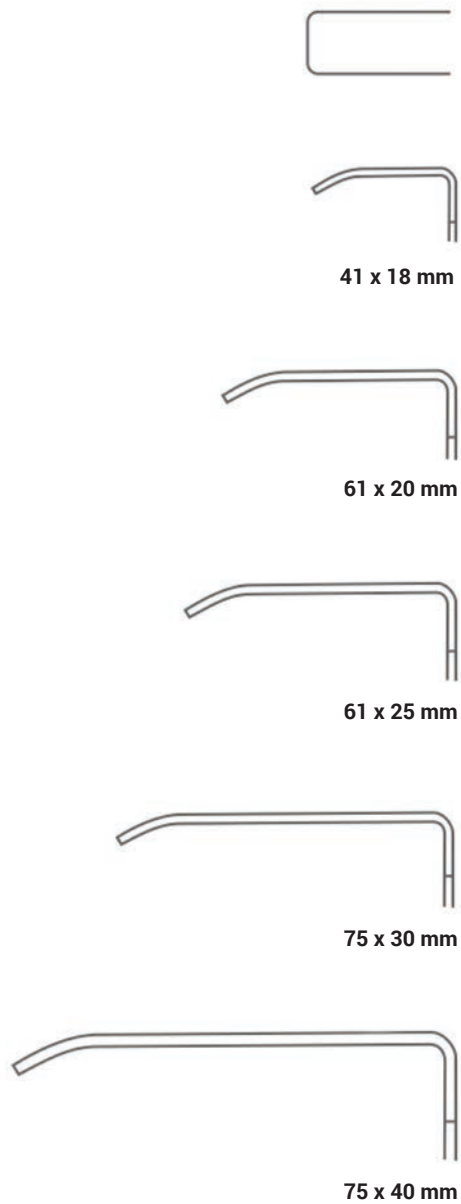

Description

Kocher Langenbeck Retractor 41x18 mm
 Kocher Langenbeck Retractor 61x20 mm
 Kocher Langenbeck Retractor 61x25 mm
 Kocher Langenbeck Retractor 75x30 mm
 Kocher Langenbeck Retractor 75x40 mm

Length

21 cm
 21 cm
 21 cm
 21 cm
 21 cm

Code

BG-025-05
 BG-025-06
 BG-025-07
 BG-025-08
 BG-025-09



CARDIOVASCULAR RETRACTOR

CARDIOVASCULAR RETRACTOR

Kocher-Langenbeck Retractor

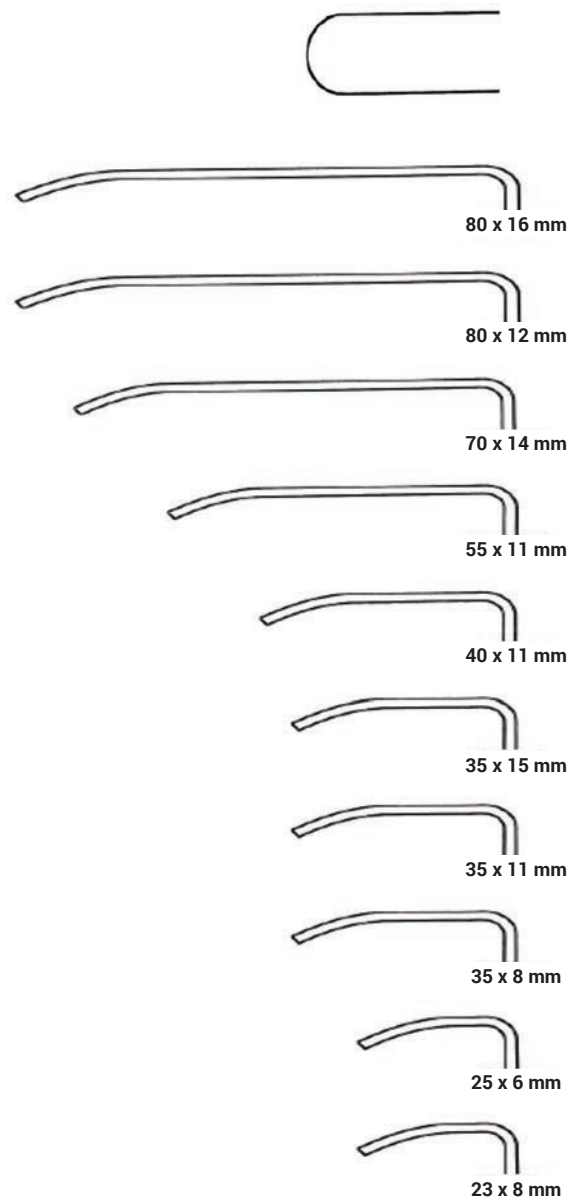
**Description**

Kocher-Langenbeck Retractor 23 x 8 mm
 Kocher-Langenbeck Retractor 25 x 6 mm
 Kocher-Langenbeck Retractor 35 x 8 mm
 Kocher-Langenbeck Retractor 35 x 11 mm
 Kocher-Langenbeck Retractor 35 x 15 mm
 Kocher-Langenbeck Retractor 40 x 11 mm
 Kocher-Langenbeck Retractor 55 x 11 mm
 Kocher-Langenbeck Retractor 70 x 14 mm
 Kocher-Langenbeck Retractor 80 x 12 mm
 Kocher-Langenbeck Retractor 80 x 16 mm

Length

21 cm
 21 cm
 21 cm
 21 cm
 21 cm
 21 cm
 21 cm
 21 cm
 21 cm
 21 cm

Code

BG-025-00
 BG-025-01
 BG-025-02
 BG-025-03
 BG-025-04
 BG-025-05
 BG-025-06
 BG-025-07
 BG-025-08
 BG-025-09

Kocher-Langenbeck Retractor

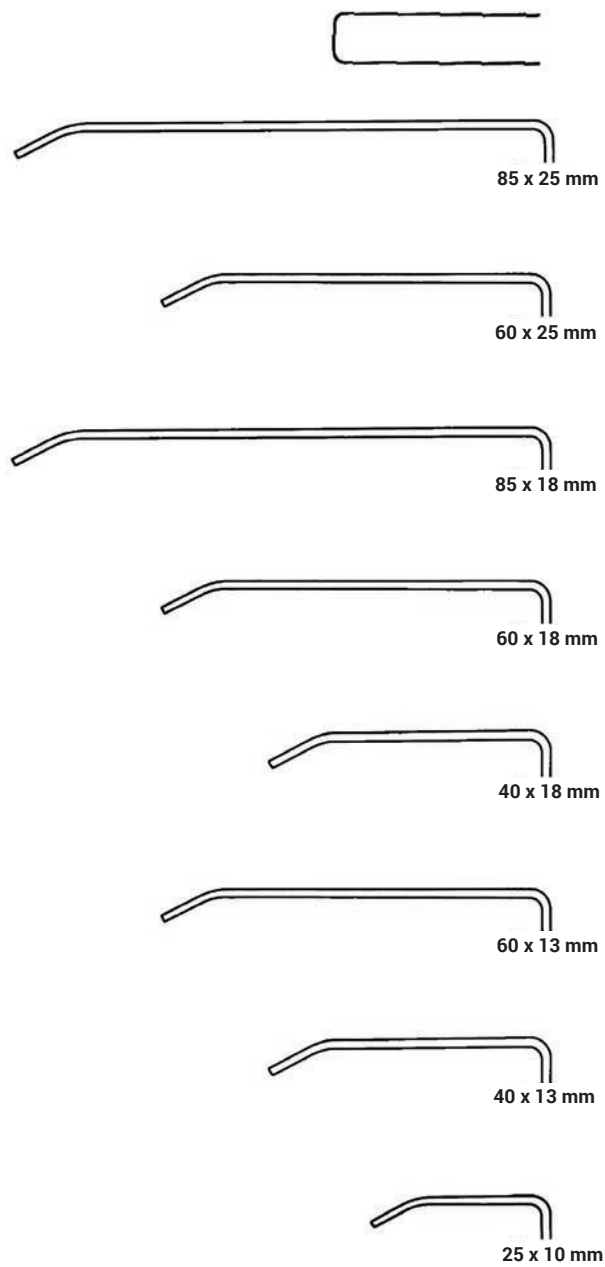
**Description**

Kocher-Langenbeck Retractor 25 x 10 mm
 Kocher-Langenbeck Retractor 40 x 13 mm
 Kocher-Langenbeck Retractor 60 x 13 mm
 Kocher-Langenbeck Retractor 40 x 18 mm
 Kocher-Langenbeck Retractor 60 x 18 mm
 Kocher-Langenbeck Retractor 85 x 18 mm
 Kocher-Langenbeck Retractor 60 x 25 mm
 Kocher-Langenbeck Retractor 85 x 25 mm

Length

21 cm
 21 cm
 21 cm
 21 cm
 21 cm
 21 cm
 21 cm
 21 cm

Code

BG-025-11
 BG-025-12
 BG-025-13
 BG-025-14
 BG-025-15
 BG-025-16
 BG-025-17
 BG-025-18

Ross Retractor Serrated

Description	Dimension	Code
Ross Retractor Serrated, 25 cm, Small	16 x 16 mm	CB1-10-9325-60
Ross Retractor Serrated, 25 cm, Medium	24 x 14 mm	CB1-10-9325-61
Ross Retractor Serrated, 25 cm, Large	24 x 17 mm	CB1-10-9325-62

Marberger Retractor

Description	Dimension	Code
Marberger Retractor, 24 cm, Small	17 mm	CB1-10-9325-63
Marberger Retractor, 24 cm, Medium	20 mm	CB1-10-9325-64
Marberger Retractor, 24 cm, Large	23 mm	CB1-10-9325-65

Cooley-type Rake Retractor Malleable

Description	Dimension	Code
Cooley-type Rake Retractor Malleable 26 cm, Small	20 mm	CB1-10-9325-66
Cooley-type Rake Retractor Malleable 26 cm, Medium	35 mm	CB1-10-9325-67
Cooley-type Rake Retractor Malleable 26 cm, Large	45 mm	CB1-10-9325-68



Harrington Cardio Retractors

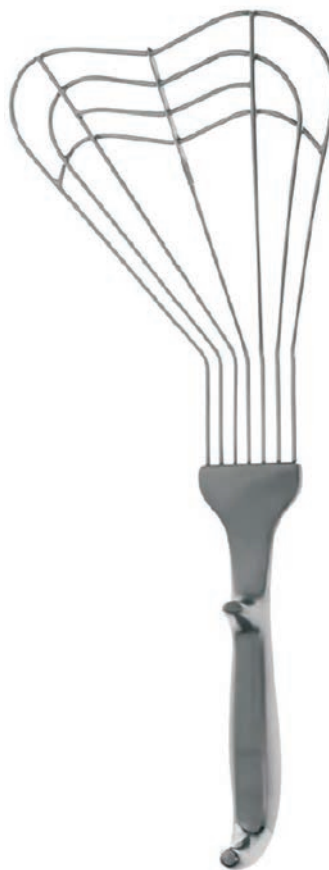
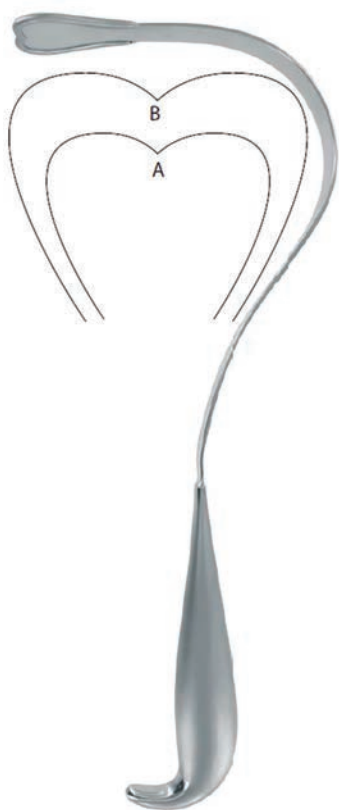

Description
Harrington Steel
Handle

40 mm

Code
DA-1500-01

32 cm

Code
DA-1500-02

Description
Harrington Silicone
Handle

40 mm

Code
DA-1500-03

32 cm

Code
DA-1500-04

Description
Harrington Steel
Handle

40 mm

Code
DA-1500-05

32 cm



CARDIOVASCULAR RETRACTOR

CARDIOVASCULAR RETRACTOR

Deaver Retractor



DuBost Hand Retractor

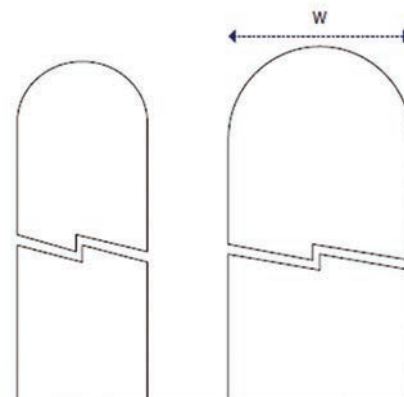

Length
255 mm

Depth
28 mm

Length
255 mm

Depth
35 mm

Description
Deaver Retractor

Length 30 cm
Depth 25 mm

Code
DA-1501-01

Length 30 cm
Depth 38 mm

Code
DA-1501-02

Length 30 cm
Depth 50 mm

Code
DA-1501-03

Length 30 cm
Depth 55 mm

Code
DA-1501-04



Description
DuBost Hand Retractor

Length 26 cm
Depth 28 mm

Code
DA-1503-01

Length 26 cm
Depth 35 mm

Code
DA-1503-02

Allison Hand Retractor



Description
Allison Hand
Retractor

Length 25 cm

Code
DA-1505-01



Description
Allison Hand
Retractor

Length 30 cm

Code
DA-1505-02



CARDIOVASCULAR RETRACTOR

Memory (Nitinol) Retractor Malleable

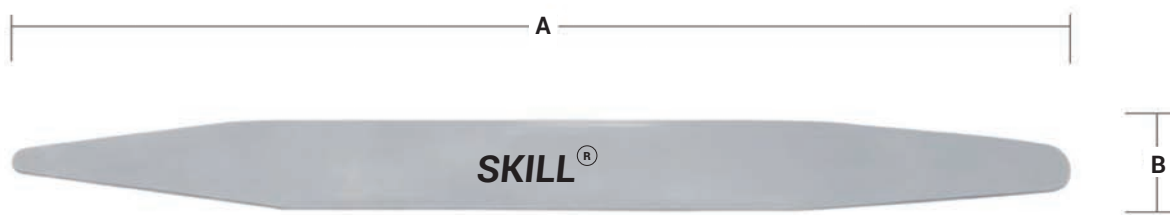

Description	Length	Code
Memory (Nitinol) Retractor Malleable 10 mm	20 cm	BG-075-01
Memory (Nitinol) Retractor Malleable 15 mm	20 cm	BG-075-02
Memory (Nitinol) Retractor Malleable 20 mm	20 cm	BG-075-03

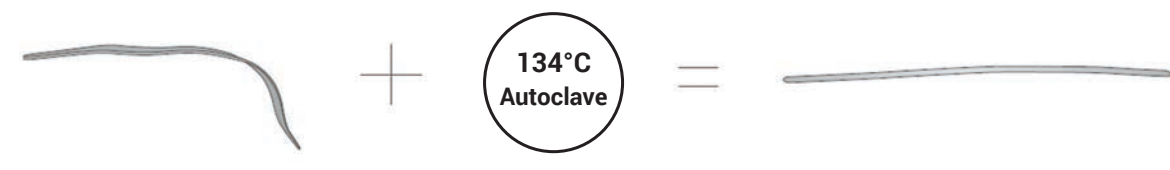

Epicardial Retractor 3x3 Teeth



Description	Code
Epicardial Retractor 3x3 Teeth Blunt 25 mm	DA-1400-01
Epicardial Retractor 3x3 Teeth Blunt 31 mm	DA-1400-02
Epicardial Retractor 3x3 Teeth Blunt 38 mm	DA-1400-03
Epicardial Retractor 3x3 Teeth Blunt 54 mm	DA-1400-04
Epicardial Retractor 3x3 Teeth Sharp 25 mm	DA-1401-01
Epicardial Retractor 3x3 Teeth Sharp 31 mm	DA-1401-02
Epicardial Retractor 3x3 Teeth Sharp 38 mm	DA-1401-03
Epicardial Retractor 3x3 Teeth Sharp 54 mm	DA-1401-04

Alm Retractor



Description	Length	Code
Alm Retractor Blunt	7 cm	BG-007-07
Alm Retractor Blunt	10 cm	BG-007-10
Alm Retractor Sharp	7 cm	BG-008-07
Alm Retractor Sharp	10 cm	BG-008-10

Weitlander Retractor



Description	Length	Code
Weitlander Retractor Blunt 2x3 Teeth	11 cm	BG-217-11
Weitlander Retractor Blunt 3x4 Teeth	13 cm	BG-217-13
Weitlander Retractor Blunt 3x4 Teeth	16 cm	BG-217-16
Weitlander Retractor Blunt 3x4 Teeth	20 cm	BG-217-20
Weitlander Retractor Blunt 3x4 Teeth	25 cm	BG-217-25
Weitlander Retractor Semi Sharp 3x4 Teeth	11 cm	BG-218-11
Weitlander Retractor Semi Sharp 3x4 Teeth	13 cm	BG-218-13
Weitlander Retractor Semi Sharp 3x4 Teeth	16 cm	BG-218-16
Weitlander Retractor Semi Sharp 3x4 Teeth	20 cm	BG-218-20
Weitlander Retractor Semi Sharp 3x4 Teeth	25 cm	BG-218-25
Weitlander Retractor Sharp 2x3 Teeth	11 cm	BG-219-11
Weitlander Retractor Sharp 3x4 Teeth	13 cm	BG-219-13
Weitlander Retractor Sharp 3x4 Teeth	16 cm	BG-219-16
Weitlander Retractor Sharp 3x4 Teeth	20 cm	BG-219-20
Weitlander Retractor Sharp 3x4 Teeth	25 cm	BG-219-25



Anderson Adson Retractor



4 x 4
Sharp
Prongs



4 x 4
Blunt
Prongs

Description

Anderson Adson Retractor 4 x 4 Teeth Sharp

Anderson Adson Retractor 4 x 4 Teeth Blunt

Length

20 cm

20 cm

Code

BG-240-20

BG-241-20



Travers Retractor



**4 x 4
Blunt
Prongs**

Description

Travers Retractor 4 x d5 Teeth Blunt

Length

21 cm

Code

BG-247-21

Ionescu Handheld Valve Retractor



Description

Ionescu Handheld Valve Retractor Double Ended 6 mm/7 mm

Length

21 cm

Code

BG-9801-01

Ionescu Handheld Valve Retractor

**Description**

Ionescu Handheld Valve Retractor 1.2 mm/1.7 mm

Ionescu Handheld Valve Retractor 2.2 mm/2.5 mm

Length

18 cm

23 cm

Code

BG-9801-02

BG-9801-03



SKILL Atraumatic Retraction System

Complete System Code: CB1-10-600-00

PRODUCT INFORMATION

ARS - The Atraumatic Retraction System for Sternotomies

- Universal and modular system.
- To be used with various atrial retractor blades and additional accessories (e.g. snake arm)
- Integrated suture holders for fixation and organisation of sutures (up to 10 sutures) during operations with and without heart-lung machine.
- Design of the system allows maximum possible exposition of OR field.
- OR-table fixation arm.

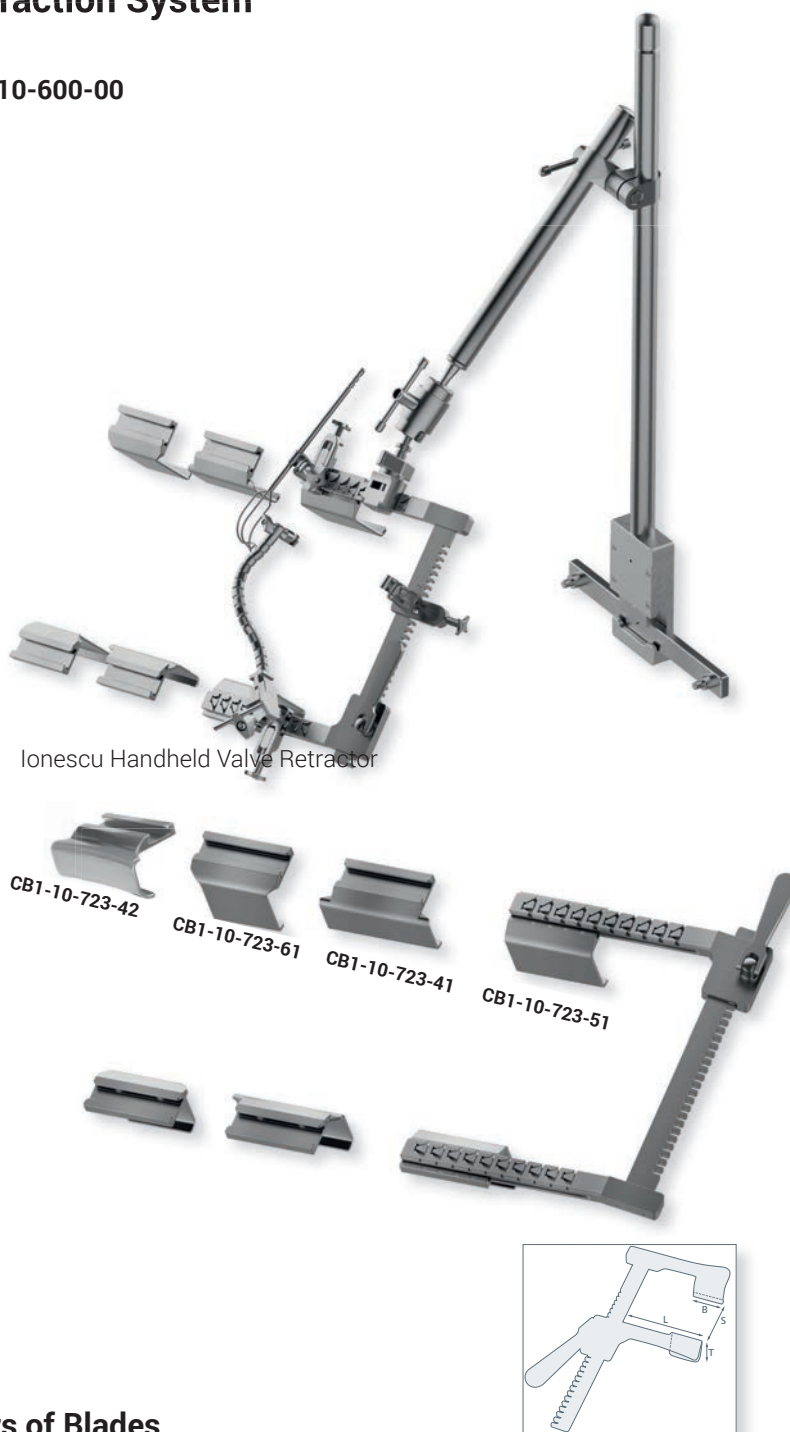

Ionescu Handheld Valve Retractor

CB1-10-723-42

CB1-10-723-61

CB1-10-723-41





CB1-10-723-51

ARS-Spreader with 4 pairs of Blades

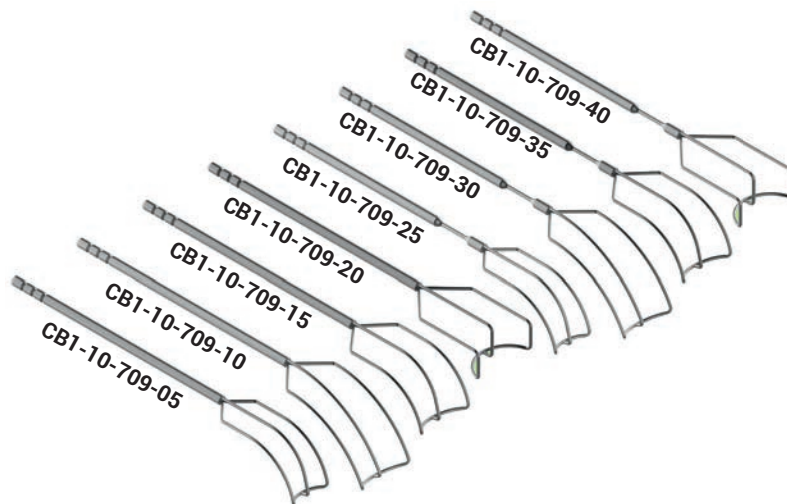
Item Description	Description	Spreading width (S)	Arm length (L)
CB1-10-600-05	ARS-Spreader with suture holders	245 mm	193 mm
Inclusive		Width (B)	Depth (T)
CB1-10-723-51	Pair of blades	80 mm	50 mm
CB1-10-723-41	Pair of blades	100 mm	40 mm
CB1-10-723-61	Pair of blades	60 mm	60 mm
CB1-10-723-42	Pair of blades curved	100 mm	100 mm

SKILL Cooley Atrial Blades, Shaft Diameter, 6 mm



Item number	Width	Length	Malleable
CB1-10-709-05	28 mm	35 mm	
CB1-10-709-10	38 mm	48 mm	
CB1-10-709-15	38 mm	35 mm	
CB1-10-709-20	42 mm	22 mm	
CB1-10-709-25	28 mm	35 mm	
CB1-10-709-30	38 mm	48 mm	
CB1-10-709-35	38 mm	35 mm	
CB1-10-709-40	42 mm	22 mm	



Flexible Arm (type Leyla)
Length 185 mm

CB1-10-600-25

**Clamp for fixation of
Blades/Retractors**
(e.g. Colley blades) diameter 6 mm



CB1-10-600-20

**Clamp for Leyla arm for
use with ARS-spreader**



CB1-10-600-22

**Fixation arm for
adaption of
ARS-spreader
to OR-table**



CB1-10-600-30

MIDCAB Retractor System Complete

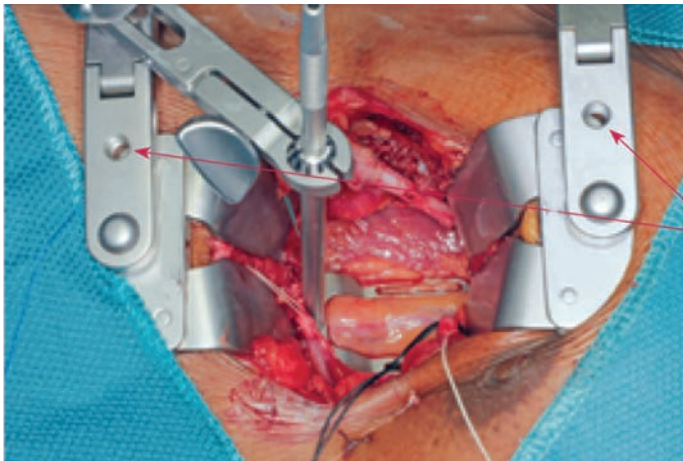

Fixation points

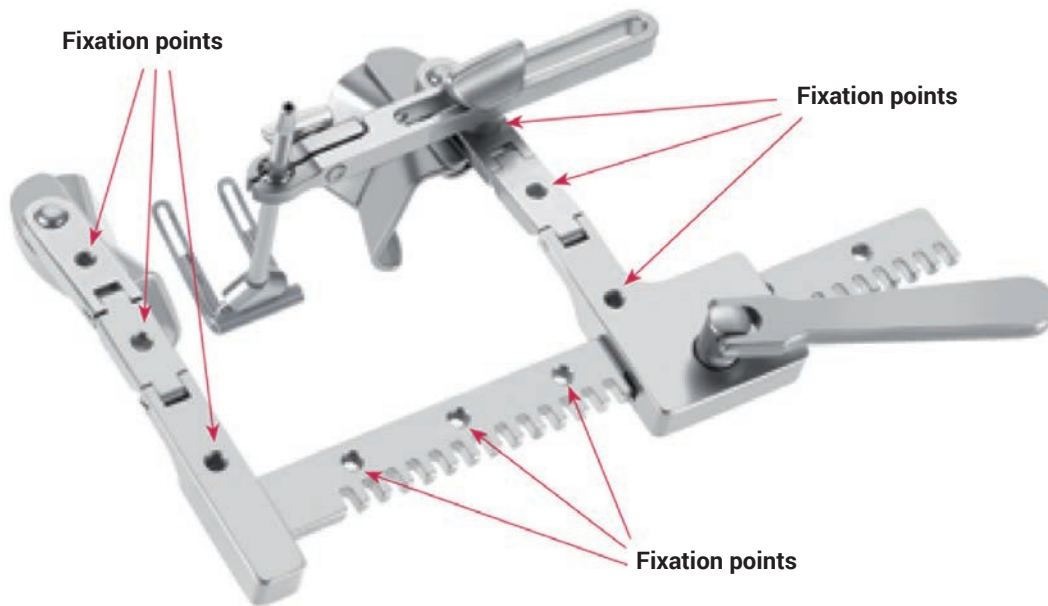

Fixation points

Fixation points

Fixation points

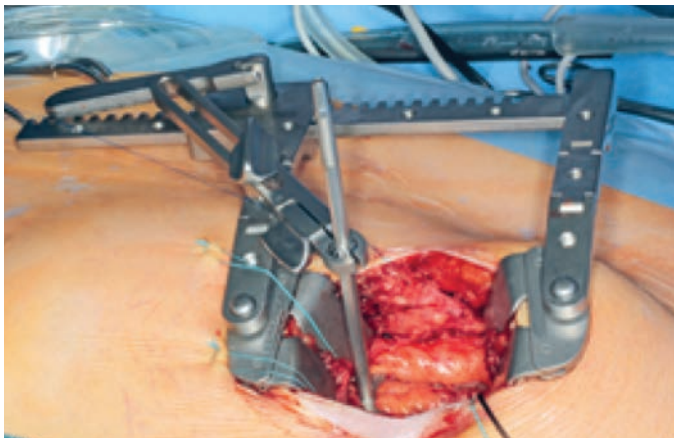

CARDIOVASCULAR RETRACTOR

MIDCAB Retractor System Complete Blades and Stabilizer

CB1-10-9890-00

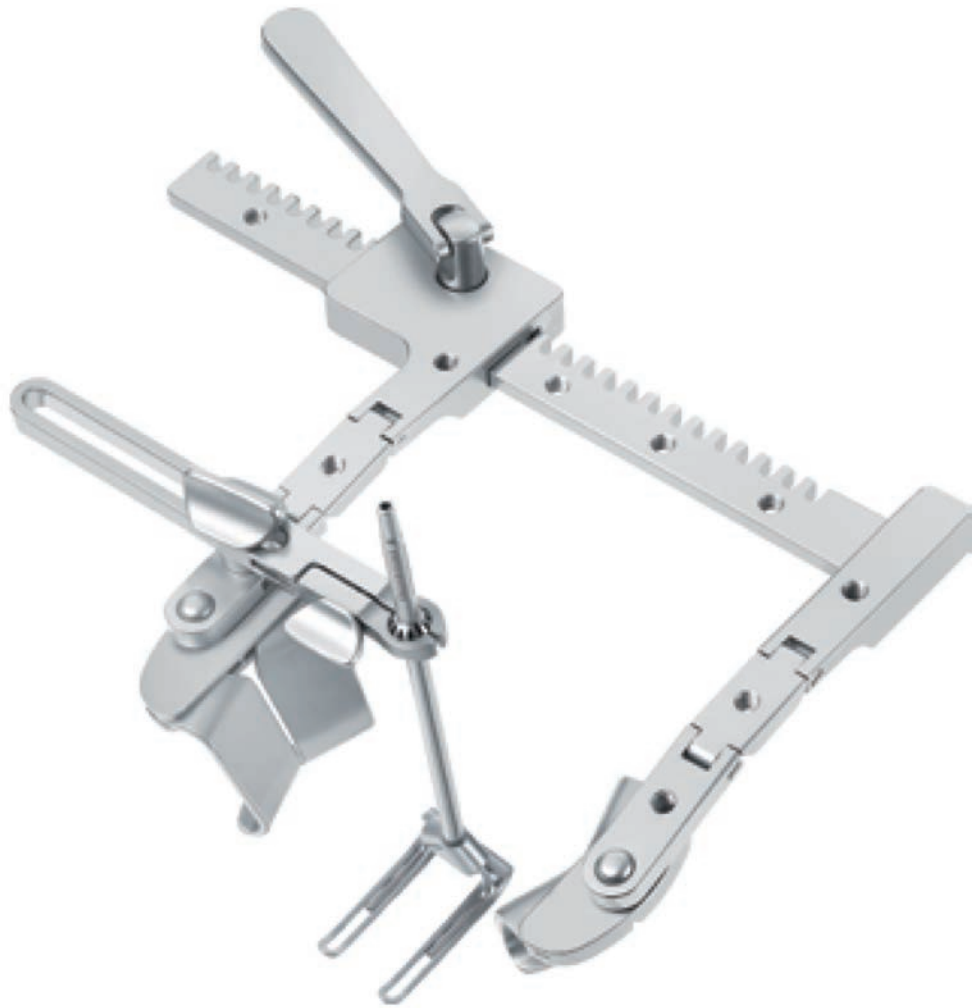

MIDCAB Retractor Only Double Joint

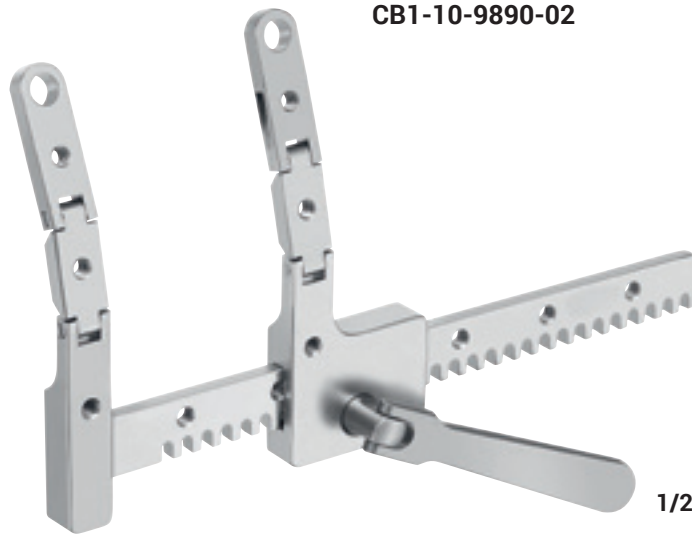

CB1-10-9890-02

1/2

MIDCAB Adapter



1/2

CB1-10-9890-01

MIDCAB Stabilizer



1/2

CB1-10-9890-03



CARDIOVASCULAR RETRACTOR

CARDIOVASCULAR RETRACTOR

MIDCAB Double Blades (solid individually)

CB1-10-9890-40

40 mm



1/2

CB1-10-9890-50

50 mm



1/2

CB1-10-9890-60

60 mm



1/2



1/2

CB1-10-9890-70

70 mm



1/2

CB1-10-9890-80

80 mm



SKILL MICS Aortic Clamp Set

The system is easily introduced and removed through the MICS Retractor. This eliminated the need for a dedicated aortic clamp Incision/access, further reducing potential risks to patients. It is designed so the handle is removed after the insertion of the clamp, eliminating visual impedance of the operating field.



CB1-195.98



CB1-195.99



Aortic Clamp Set Straight
CB1-195.80



Aortic Clamp Set Right
CB1-195.90



Aortic Clamp Set Left
CB1-195.70

Name	Description	Code
MICS Aortic Clamp Set Left 2x3 DeBakey	Set Left: Small 75 mm, Medium 85 mm, Large 95 mm	CB1-195.70
MICS Aortic Clamp Set Straight 2x3 DeBakey	Set Straight: Small 75 mm, Medium 85 mm, Large 95 mm	CB1-195.80
MICS Aortic Clamp Set Right 2x3 DeBakey	Set Right: Small 75 mm, Medium 85 mm, Large 95 mm	CB1-195.90

SKILL MICS Aortic Clamp Set

The system is easily introduced and removed through the MICS Retractor. This eliminated the need for a dedicated aortic clamp Incision/access, further reducing potential risks to patients. It is designed so the handle is removed after the insertion of the clamp, eliminating visual impedance of the operating field.



CB1-195.98



CB1-195.99



Aortic Clamp Set Left Bent
CB1-195.75



Aortic Clamp Set Right
CB1-195.85

Name	Description	Code
MICS Aortic Clamp Set Left Bent 2x3 DeBakey	Set Left: Small 75 mm, Medium 85 mm, Large 95 mm	CB1-195.75
MICS Aortic Clamp Set Right Bent 2x3 DeBakey	Set Right: Small 75 mm, Medium 85 mm, Large 95 mm	CB1-195.85

SKILL MICS Aortic Parallel Clamp Set

The system is easily introduced and removed through the MICS Retractor. The new MICS Aortic Parallel Clamp Set reduces significantly and even more the vessel traumatic effects close by zero percent and potential risks to patients, compared to the Standard Aortic Clamps.



CB1-195.98



CB1-195.99



CB1-185.95



MICS Aortic Parallel Clamp Set
CB1-185.85



Name	Description	Code
MICS Aortic Parallel Clamp Set Left Curved	Set: Small 60 mm, Medium 70 mm	CB1-185.75
MICS Aortic Parallel Clamp Set Straight	Set: Small 60 mm, Medium 70 mm	CB1-185.85
MICS Aortic Parallel Clamp Set Right Curved	Set: Small 60 mm, Medium 70 mm	CB1-185.95

SKILL MICS Atrial Blade Set

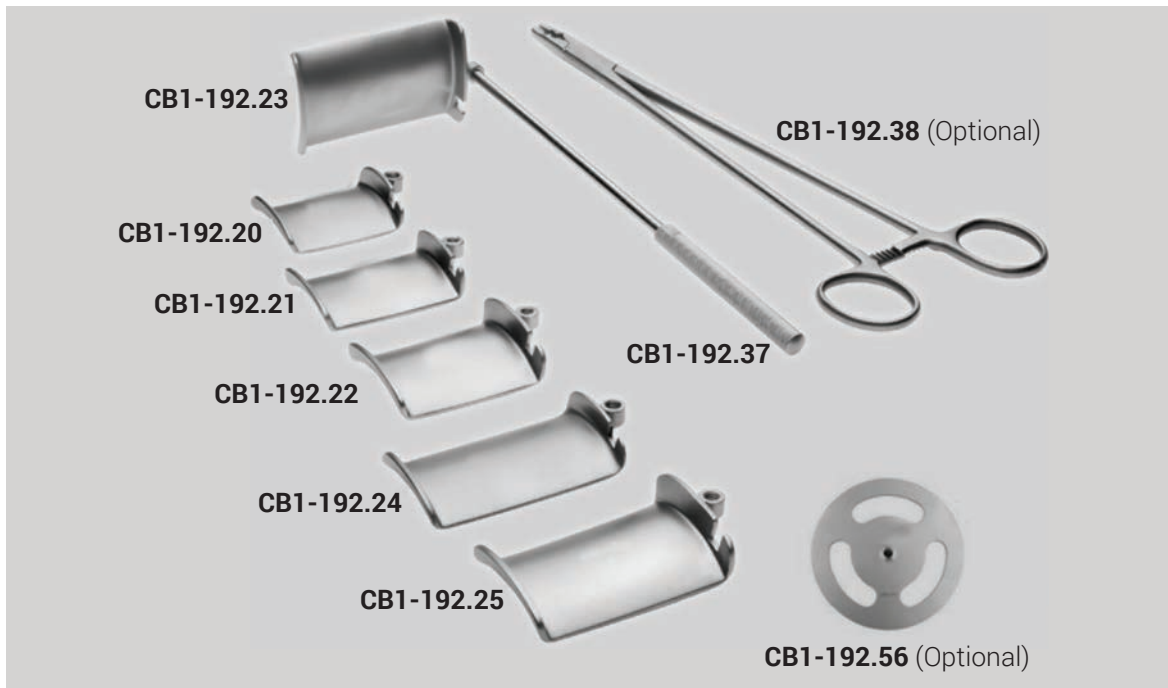

Name	Description	Code
MICS Atrial Mitral Blade Set	Containing Holder, Forceps and Blades: CB1-192.37, CB1-192.20, CB1-192.21, CB1-192.22, CB1-192.23, CB1-192.24, CB1-192.25	CB1-192.75

MICS Holding Fixation Platform	Diameter 95 mm	CB1-192.56 (Optional)
MICS Holder Forceps for Atrial Blades	140 mm	CB1-192.37
MICS Forceps for Atrial Blades	250 mm	CB1-192.38 (Optional)
MICS Atrial Blade	35 x 40 mm (BXL)	CB1-192.20
MICS Atrial Blade	35 x 40 mm (BXL)	CB1-192.21
MICS Atrial Blade	35 x 60 mm (BXL)	CB1-192.22
MICS Atrial Blade	40 x 50 mm (BXL)	CB1-192.23
MICS Atrial Blade	40 x 60 mm (BXL)	CB1-192.24
MICS Atrial Blade	40 x 70 mm (BXL)	CB1-192.25

Name	Description	Code
MICS Atrial Tricuspidal Blade Set	Containing Holder, Forceps and Blades: CB1-192.37, CB1-192.40, CB1-192.41, CB1-192.42, CB1-192.43, CB1-192.44, CB1-192.45	CB1-192.76

MICS Holding Fixation Platform	Diameter 95 mm	CB1-192.56 (Optional)
MICS Holder Forceps for Atrial Blades	140 mm	CB1-192.37
MICS Forceps for Atrial Blades	250 mm	CB1-192.38 (Optional)
MICS Atrial Blade	20 x 40 mm (BXL)	CB1-192.40
MICS Atrial Blade	20 x 25 mm (BXL)	CB1-192.41
MICS Atrial Blade	25 x 25 mm (BXL)	CB1-192.42
MICS Atrial Blade	25 x 50 mm (BXL)	CB1-192.43
MICS Atrial Blade	40 x 25 mm (BXL)	CB1-192.44
MICS Atrial Blade	50 x 25 mm (BXL)	CB1-192.45



SKILL[®]

Surgical Instruments

MICS & VATS CARDIAC INSTRUMENTS





Index

MICS Vats Cardiac Instruments

Scissors	369- 376
Grasping Forceps	377-382
Needle Holders	383-389
Special Instruments	390-395
Chest Tube Passers	396
CMICS Instruments VATS Instruments	398
VATS Scissors	399-401
VATS Needle Holder	401-402
VATS DeBakey Clamp	402-404
VATS Harken and Satinsky Clamp	405-408
VATS Foerster Lung Grasping Clamp	409-411
VATS Dissector Clamp	411-414
VATS Duval Lung Grasping Clamp	414
Valve Extra Long Rongeurs	415
Dissector Sliding Clamp	415-416
Sliding Scissors Super Cut	417
Double Action Grasper Clamp Hallmann Double Action Scissors	418
D'Amico Biopsy Forceps	419
Gonzalez-Rivas Lung Grasping Clamp	420
Foerster Lung Grasping Clamp	421
Node Grasping Clamp Khan Decortication Grasper	423
Gonzalez-Rivas Dissector	424-426
Snake Dissector Small	424-425
Dennis Dissector	425
Harken Clamps	426
Allis Forceps	427
MICS Suction Instrument Knot Pusher Cardioplegia Needle Magnet Finder	428
Endo TC Needle Holder	429-437
Clip applying Forceps Ø 10.0 mm for Bulldog Clamps	437
Bulldog Clamps DeBakey	438
Fan Retractors	439-440
Endo Retractors	440-445
SKILL Thoracic Suction Tube	445-447
Adam Yozu Retractor	448-450
Mini-Thoracotomy Retractors	451-452
Fixation Clamps	452

MICS & VATS INSTRUMENTS



CARDIO VASCULAR INSTRUMENTS



SCISSORS

GRASPING FORCEPS

NEEDLE HOLDERS

SPECIAL INSTRUMENTS



Handles

Handle 50D ... *Flush-port on the Shaft*

Scissors Red

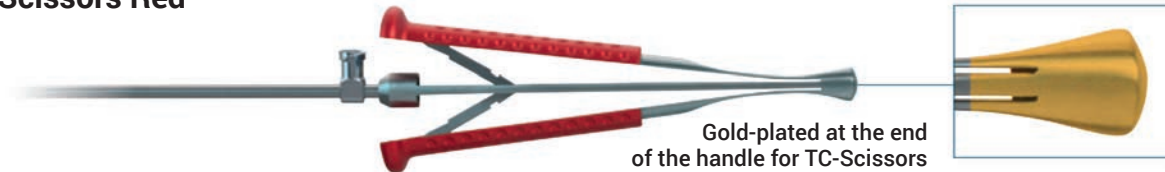

Grasping Forceps Gold

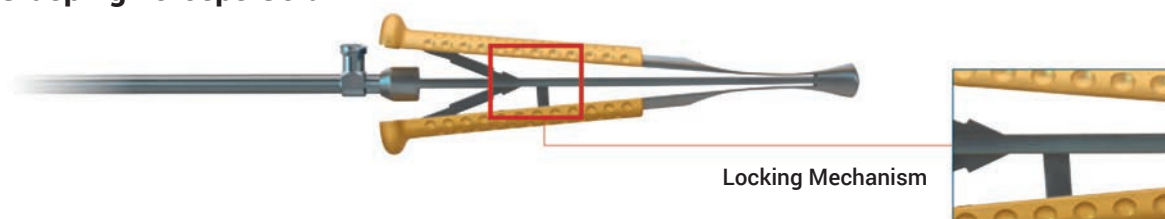

Needle Holder Blue

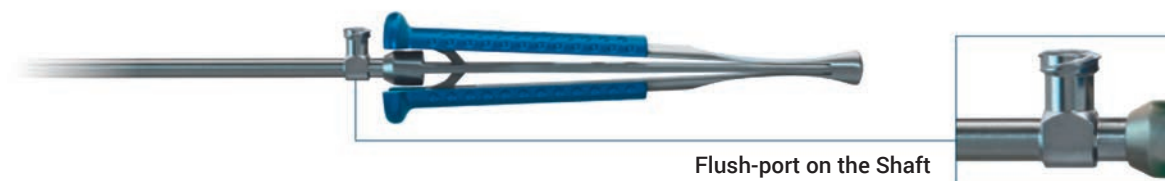

Special Instruments Green



Dimensions

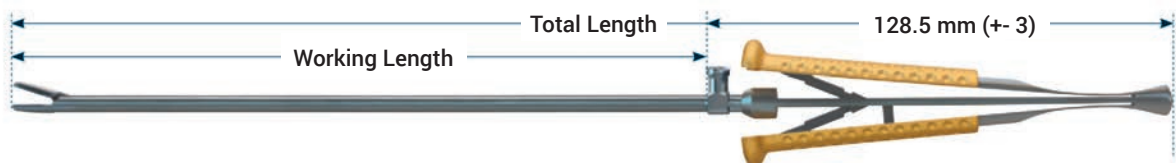

Handles

Handle 51D ... *Flush-port at the end of the handle*

Scissors Red

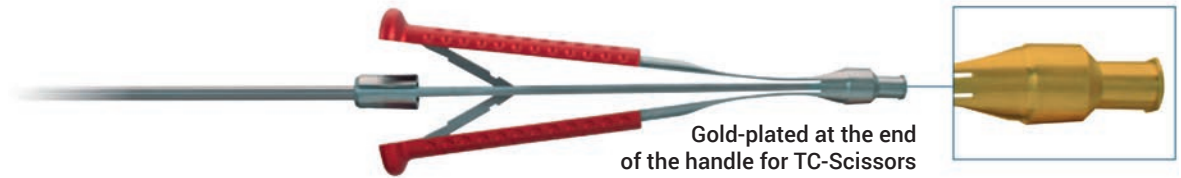

Grasping Forceps Gold

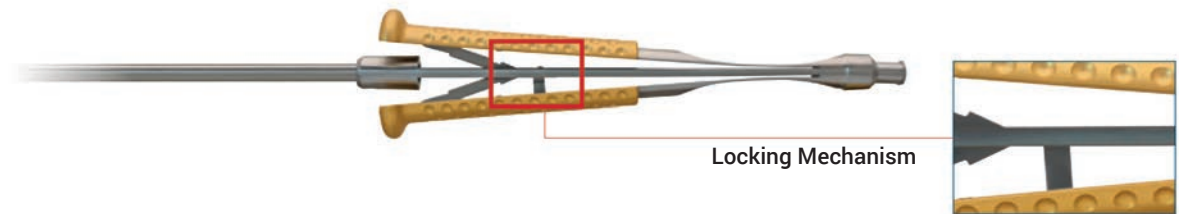

Needle Holder Blue

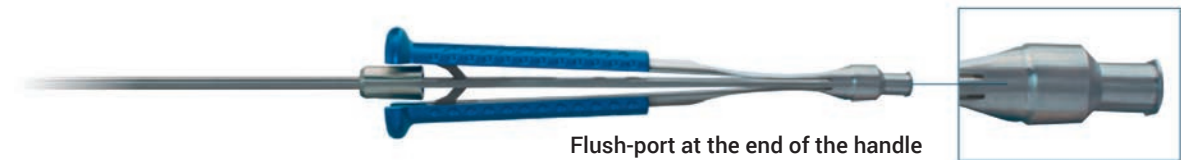

Special Instruments Green



Dimensions

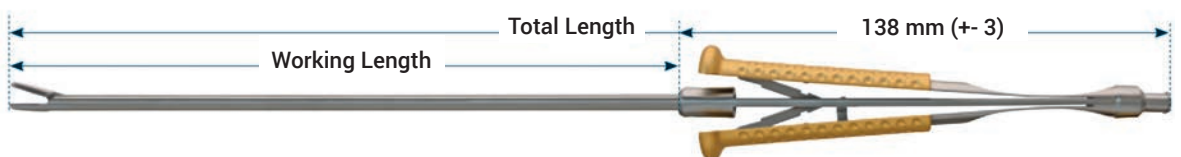

Scissors



Scissors Single Action, Angled 25°

Working/Total Length	Jaw-Ø	Shaft-Ø	Code	Locking	Tip
151 mm / 300 mm	3 mm	3 mm	FR-2000-30		
211 mm / 350 mm	3 mm	3 mm	FR-2000-35		
261 mm / 400 mm	3 mm	3 mm	FR-2000-40		



Scissors Single Action, Angled 45°

Working/Total Length	Jaw-Ø	Shaft-Ø	Code	Locking	Tip
151 mm / 300 mm	3 mm	3 mm	FR-2001-30		
211 mm / 350 mm	3 mm	3 mm	FR-2001-35		
261 mm / 400 mm	3 mm	3 mm	FR-2001-40		



Scissors Single Action, Angled 60°

Working/Total Length	Jaw-Ø	Shaft-Ø	Code	Locking	Tip
151 mm / 300 mm	3 mm	3 mm	FR-2002-30		
211 mm / 350 mm	3 mm	3 mm	FR-2002-35		
261 mm / 400 mm	3 mm	3 mm	FR-2002-40		



Scissors Single Action, Angled 90°

Working/Total Length	Jaw-Ø	Shaft-Ø	Code	Locking	Tip
151 mm / 300 mm	3 mm	3 mm	FR-2003-30		
211 mm / 350 mm	3 mm	3 mm	FR-2003-35		
261 mm / 400 mm	3 mm	3 mm	FR-2003-40		



Scissors

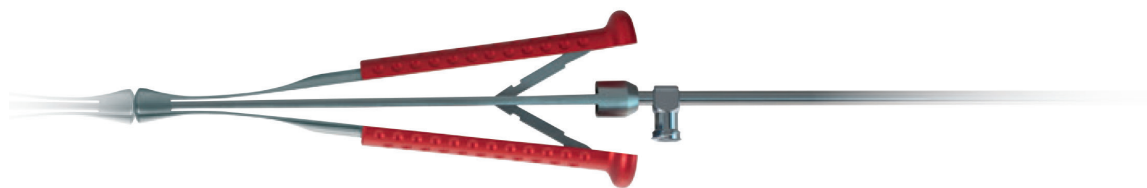

Scissors Single Action, Angled 120°

Working/Total Length	Jaw-Ø	Shaft-Ø	Code	Locking	Tip
151 mm / 300 mm	3 mm	3 mm	FR-2004-30		
211 mm / 350 mm	3 mm	3 mm	FR-2004-35		
261 mm / 400 mm	3 mm	3 mm	FR-2004-40		



Scissors Single Action, Straight

Working/Total Length	Jaw-Ø	Shaft-Ø	Code	Locking	Tip
161 mm / 300 mm	3.5 mm	3.4 mm	FR-2005-30		
221 mm / 350 mm	3.5 mm	3.4 mm	FR-2005-35		
271 mm / 400 mm	3.5 mm	3.4 mm	FR-2005-40		



Scissors Single Action, Angled 45°

Working/Total Length	Jaw-Ø	Shaft-Ø	Code	Locking	Tip
161 mm / 300 mm	3.5 mm	3.4 mm	FR-2006-30		
221 mm / 350 mm	3.5 mm	3.4 mm	FR-2006-35		
271 mm / 400 mm	3.5 mm	3.4 mm	FR-2006-40		



Scissors Single Action, Angled 90°

Working/Total Length	Jaw-Ø	Shaft-Ø	Code	Locking	Tip
151 mm / 300 mm	3.5 mm	3.4 mm	FR-2007-30		
211 mm / 350 mm	3.5 mm	3.4 mm	FR-2007-35		
261 mm / 400 mm	3.5 mm	3.4 mm	FR-2007-40		



Scissors

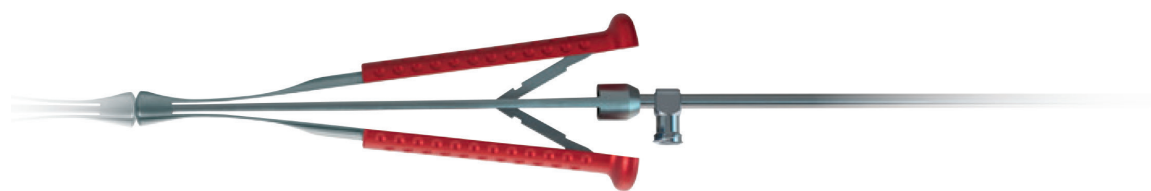

Scissors Single Action, Angled 120°

Working/Total Length	Jaw-Ø	Shaft-Ø	Code	Locking	Tip
151 mm / 300 mm	3.5 mm	3.4 mm	FR-2008-30		
211 mm / 350 mm	3.5 mm	3.4 mm	FR-2008-35		
261 mm / 400 mm	3.5 mm	3.4 mm	FR-2008-40		



Scissors Single Action, Curved Right

Working/Total Length	Jaw-Ø	Shaft-Ø	Code	Locking	Tip
161 mm / 300 mm	3.5 mm	3.4 mm	FR-2009-30		
221 mm / 350 mm	3.5 mm	3.4 mm	FR-2009-35		
271 mm / 400 mm	3.5 mm	3.4 mm	FR-2009-40		



Scissors Single Action, Curved Left

Working/Total Length	Jaw-Ø	Shaft-Ø	Code	Locking	Tip
161 mm / 300 mm	3.5 mm	3.4 mm	FR-2010-30		
221 mm / 350 mm	3.5 mm	3.4 mm	FR-2010-35		
271 mm / 400 mm	3.5 mm	3.4 mm	FR-2010-40		



Scissors Single Action, Angled 30°

Working/Total Length	Jaw-Ø	Shaft-Ø	Code	Locking	Tip
174 mm / 300 mm	5 mm	5 mm	FR-2011-30		
224 mm / 350 mm	5 mm	5 mm	FR-2011-35		
274 mm / 400 mm	5 mm	5 mm	FR-2011-40		



Scissors

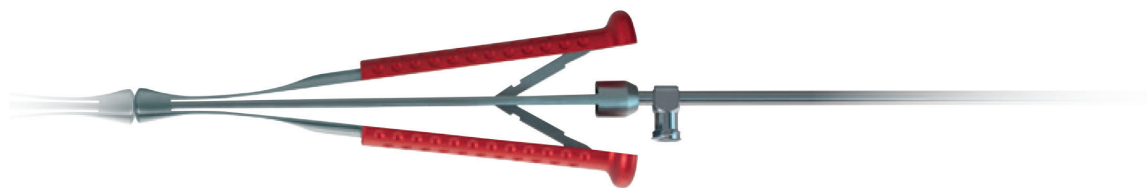

Scissors Single Action, Angled 45°

Working/Total Length	Jaw-Ø	Shaft-Ø	Code	Locking	Tip
174 mm / 300 mm	5 mm	5 mm	FR-2012-30		
224 mm / 350 mm	5 mm	5 mm	FR-2012-35		
274 mm / 400 mm	5 mm	5 mm	FR-2012-40		



Scissors Single Action, Angled 90°

Working/Total Length	Jaw-Ø	Shaft-Ø	Code	Locking	Tip
164 mm / 300 mm	5 mm	5 mm	FR-2013-30		
214 mm / 350 mm	5 mm	5 mm	FR-2013-35		
264 mm / 400 mm	5 mm	5 mm	FR-2013-40		



Scissors Single Action, Angled 30°

Working/Total Length	Jaw-Ø	Shaft-Ø	Code	Locking	Tip
161 mm / 300 mm	5 mm	3.4 mm	FR-2014-30		
221 mm / 350 mm	5 mm	3.4 mm	FR-2014-35		
271 mm / 400 mm	5 mm	3.4 mm	FR-2014-40		



Scissors Single Action, Angled 90°

Working/Total Length	Jaw-Ø	Shaft-Ø	Code	Locking	Tip
161 mm / 300 mm	5 mm	3.4 mm	FR-2015-30		
221 mm / 350 mm	5 mm	3.4 mm	FR-2015-35		
271 mm / 400 mm	5 mm	3.4 mm	FR-2015-40		



Scissors



Scissors Single Action, Curved Left Medium

Working/Total Length	Jaw-Ø	Shaft-Ø	Code	Locking	Tip
174 mm / 300 mm	5 mm	5 mm	FR-2016-30		
224 mm / 350 mm	5 mm	5 mm	FR-2016-35		
274 mm / 400 mm	5 mm	5 mm	FR-2016-40		



Scissors Single Action, Curved Left Strongly

Working/Total Length	Jaw-Ø	Shaft-Ø	Code	Locking	Tip
174 mm / 300 mm	5 mm	5 mm	FR-2017-30		
224 mm / 350 mm	5 mm	5 mm	FR-2017-35		
274 mm / 400 mm	5 mm	5 mm	FR-2017-40		



Scissors Double Action, Curved Medium

Working/Total Length	Jaw-Ø	Shaft-Ø	Code	Locking	Tip
161 mm / 300 mm	3.5 mm	3.4 mm	FR-2018-30		
221 mm / 350 mm	3.5 mm	3.4 mm	FR-2018-35		
271 mm / 400 mm	3.5 mm	3.4 mm	FR-2018-40		



Scissors Double Action, Straight

Working/Total Length	Jaw-Ø	Shaft-Ø	Code	Locking	Tip
184 mm / 300 mm	5 mm	5 mm	FR-2019-30		
234 mm / 350 mm	5 mm	5 mm	FR-2019-35		
284 mm / 400 mm	5 mm	5 mm	FR-2019-40		



Scissors

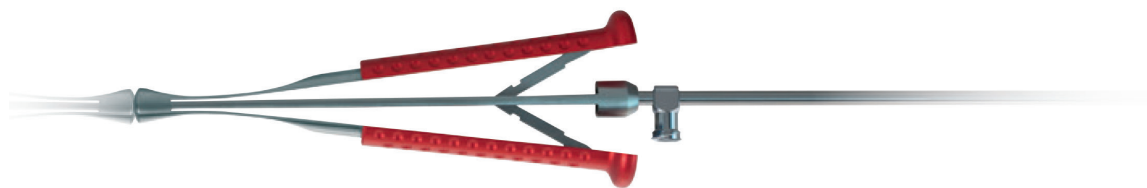

Scissors Double Action, Curved Strictly

Working/Total Length	Jaw-Ø	Shaft-Ø	Code	Locking	Tip
184 mm / 300 mm	5 mm	5 mm	FR-2020-30		
234 mm / 350 mm	5 mm	5 mm	FR-2020-35		
284 mm / 400 mm	5 mm	5 mm	FR-2020-40		



Scissors Double Action, Curved Medium

Working/Total Length	Jaw-Ø	Shaft-Ø	Code	Locking	Tip
184 mm / 300 mm	5 mm	5 mm	FR-2021-30		
234 mm / 350 mm	5 mm	5 mm	FR-2021-35		
284 mm / 400 mm	5 mm	5 mm	FR-2021-40		



Scissors Double Action, Curved Strongly

Working/Total Length	Jaw-Ø	Shaft-Ø	Code	Locking	Tip
184 mm / 300 mm	5 mm	5 mm	FR-2022-30		
234 mm / 350 mm	5 mm	5 mm	FR-2022-35		
284 mm / 400 mm	5 mm	5 mm	FR-2022-40		



Scissors Double Action, TC-Insert, Curved Slightly One Blade Serrated

Working/Total Length	Jaw-Ø	Shaft-Ø	Code	Locking	Tip
184 mm / 300 mm	5 mm	5 mm	FR-2023-30		TC-Insert
234 mm / 350 mm	5 mm	5 mm	FR-2023-35		TC-Insert
284 mm / 400 mm	5 mm	5 mm	FR-2023-40		TC-Insert



Scissors

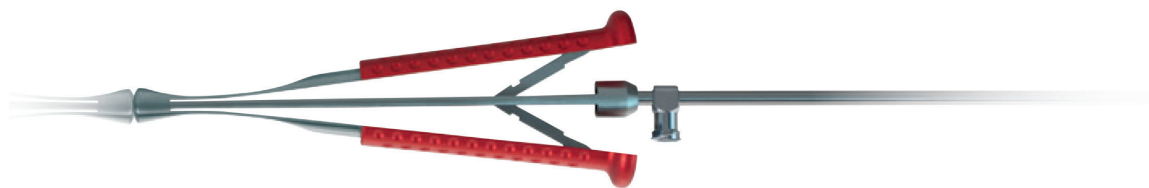

Scissors Double Action, TC-Insert, Curved Medium One Blade Serrated

Working/Total Length	Jaw-Ø	Shaft-Ø	Code	Locking	Tip
184 mm / 300 mm	5 mm	5 mm	FR-2024-30		TC-Insert
234 mm / 350 mm	5 mm	5 mm	FR-2024-35		TC-Insert
284 mm / 400 mm	5 mm	5 mm	FR-2024-40		TC-Insert



Scissors Tenotomy Double Action, Curved Slightly

Working/Total Length	Jaw-Ø	Shaft-Ø	Code	Locking	Tip
184 mm / 300 mm	5 mm	5 mm	FR-2025-30		
234 mm / 350 mm	5 mm	5 mm	FR-2025-35		
284 mm / 400 mm	5 mm	5 mm	FR-2025-40		



Scissors Tenotomy Double Action, Curved Medium

Working/Total Length	Jaw-Ø	Shaft-Ø	Code	Locking	Tip
184 mm / 300 mm	5 mm	5 mm	FR-2026-30		
234 mm / 350 mm	5 mm	5 mm	FR-2026-35		
284 mm / 400 mm	5 mm	5 mm	FR-2026-40		

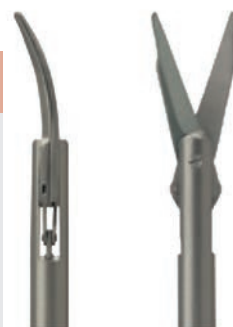

Scissors

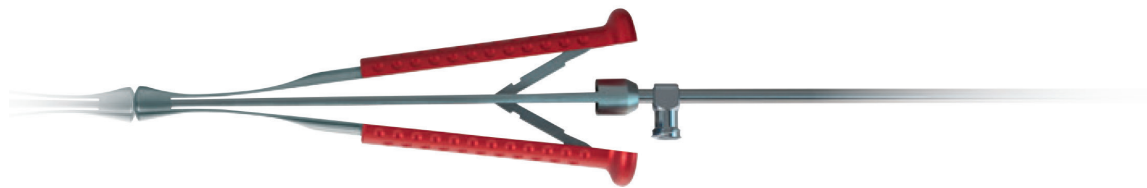

Scissors Heavy Double Action, Curved Slightly

Working/Total Length	Jaw-Ø	Shaft-Ø	Code	Locking	Tip
184 mm / 300 mm	7 mm	5 mm	FR-2027-30		
234 mm / 350 mm	7 mm	5 mm	FR-2027-35		
284 mm / 400 mm	7 mm	5 mm	FR-2027-40		



Scissors Heavy Double Action, Curved Medium

Working/Total Length	Jaw-Ø	Shaft-Ø	Code	Locking	Tip
184 mm / 300 mm	7 mm	5 mm	FR-2028-30		
234 mm / 350 mm	7 mm	5 mm	FR-2028-35		
284 mm / 400 mm	7 mm	5 mm	FR-2028-40		



Scissors Heavy Double Action, Curved Strongly

Working/Total Length	Jaw-Ø	Shaft-Ø	Code	Locking	Tip
184 mm / 300 mm	7 mm	5 mm	FR-2029-30		
234 mm / 350 mm	7 mm	5 mm	FR-2029-35		
284 mm / 400 mm	7 mm	5 mm	FR-2029-40		



Grasping Forceps

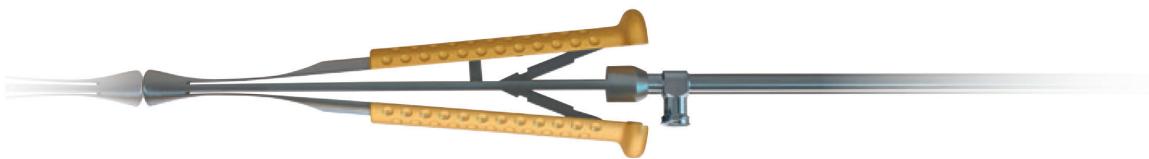

Grasper DeBakey Single Action, Straight 1,5 mm

Working/Total Length	Jaw-Ø	Shaft-Ø	Code	Locking	Tip
171 mm / 300 mm	3.5 mm	3.4 mm	FR-3000-30		1 x 2 Teeth
231 mm / 350 mm	3.5 mm	3.4 mm	FR-3000-35		1 x 2 Teeth
281 mm / 400 mm	3.5 mm	3.4 mm	FR-3000-40		1 x 2 Teeth



Grasper DeBakey Single Action, Straight 2,8 mm

Working/Total Length	Jaw-Ø	Shaft-Ø	Code	Locking	Tip
171 mm / 300 mm	3.5 mm	3.4 mm	FR-3001-30		1 x 2 Teeth
231 mm / 350 mm	3.5 mm	3.4 mm	FR-3001-35		1 x 2 Teeth
281 mm / 400 mm	3.5 mm	3.4 mm	FR-3001-40		1 x 2 Teeth



Grasper DeBakey Single Action, Upwards 45°

Working/Total Length	Jaw-Ø	Shaft-Ø	Code	Locking	Tip
161 mm / 300 mm	3.5 mm	3.4 mm	FR-3002-30		1 x 2 Teeth
221 mm / 350 mm	3.5 mm	3.4 mm	FR-3002-35		1 x 2 Teeth
271 mm / 400 mm	3.5 mm	3.4 mm	FR-3002-40		1 x 2 Teeth



Grasper DeBakey Single Action, Angled Right 45°

Working/Total Length	Jaw-Ø	Shaft-Ø	Code	Locking	Tip
171 mm / 300 mm	3.5 mm	3.4 mm	FR-3003-30		1 x 2 Teeth
231 mm / 350 mm	3.5 mm	3.4 mm	FR-3003-35		1 x 2 Teeth
281 mm / 400 mm	3.5 mm	3.4 mm	FR-3003-40		1 x 2 Teeth



Grasping Forceps

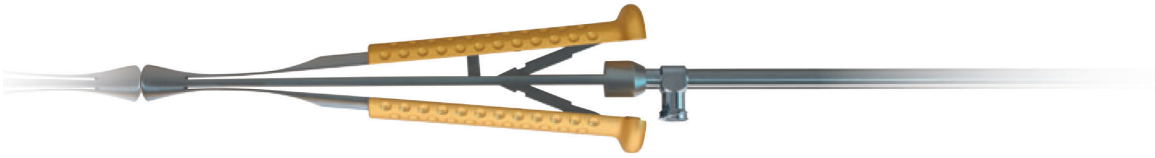

Grasper DeBakey Signle Action, Angled Left 45°

Working/Total Length	Jaw-Ø	Shaft-Ø	Code	Locking	Tip
171 mm / 300 mm	3.5 mm	3.4 mm	FR-3004-30		1 x 2 Teeth
231 mm / 350 mm	3.5 mm	3.4 mm	FR-3004-35		1 x 2 Teeth
281 mm / 400 mm	3.5 mm	3.4 mm	FR-3004-40		1 x 2 Teeth



Grasper DeBakey Signle Action, Upwards 45°

Working/Total Length	Jaw-Ø	Shaft-Ø	Code	Locking	Tip
184 mm / 300 mm	3.5 mm	5 mm	FR-3005-30		1 x 2 Teeth
234 mm / 350 mm	3.5 mm	5 mm	FR-3005-35		1 x 2 Teeth
284 mm / 400 mm	3.5 mm	5 mm	FR-3005-40		1 x 2 Teeth



Grasper DeBakey Signle Action, Angled Right 45°

Working/Total Length	Jaw-Ø	Shaft-Ø	Code	Locking	Tip
184 mm / 300 mm	3.5 mm	5 mm	FR-3006-30		1 x 2 Teeth
234 mm / 350 mm	3.5 mm	5 mm	FR-3006-35		1 x 2 Teeth
284 mm / 400 mm	3.5 mm	5 mm	FR-3006-40		1 x 2 Teeth



Grasper DeBakey Double Action, Straight 1,5 mm

Working/Total Length	Jaw-Ø	Shaft-Ø	Code	Locking	Tip
171 mm / 300 mm	3.5 mm	3.4 mm	FR-3007-30		1 x 2 Teeth
231 mm / 350 mm	3.5 mm	3.4 mm	FR-3007-35		1 x 2 Teeth
281 mm / 400 mm	3.5 mm	3.4 mm	FR-3007-40		1 x 2 Teeth



Grasping Forceps

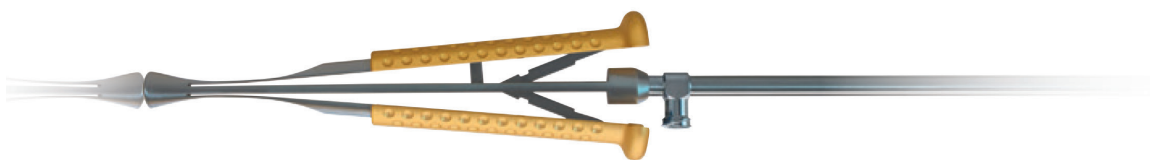

Grasper DeBakey Double Action, Angled 45°

Working/Total Length	Jaw-Ø	Shaft-Ø	Code	Locking	Tip
171 mm / 300 mm	3.5 mm	3.4 mm	FR-3008-30		1 x 2 Teeth
231 mm / 350 mm	3.5 mm	3.4 mm	FR-3008-35		1 x 2 Teeth
281 mm / 400 mm	3.5 mm	3.4 mm	FR-3008-40		1 x 2 Teeth



Grasper DeBakey Double Action, Straight 1,5 mm

Working/Total Length	Jaw-Ø	Shaft-Ø	Code	Locking	Tip
184 mm / 300 mm	5 mm	5 mm	FR-3009-30		1 x 2 Teeth
234 mm / 350 mm	5 mm	5 mm	FR-3009-35		1 x 2 Teeth
284 mm / 400 mm	5 mm	5 mm	FR-3009-40		1 x 2 Teeth



Grasper DeBakey Double Action, Straight, Malleable Shaft, 1,5 mm

Working/Total Length	Jaw-Ø	Shaft-Ø	Code	Locking	Tip
171 mm / 300 mm	5 mm	3 mm	FR-3010-30		1 x 2 Teeth
231 mm / 350 mm	5 mm	3 mm	FR-3010-35		1 x 2 Teeth
281 mm / 400 mm	5 mm	3 mm	FR-3010-40		1 x 2 Teeth



Grasper DeBakey Double Action, Angled 45° 1,5 x 15 mm

Working/Total Length	Jaw-Ø	Shaft-Ø	Code	Locking	Tip
184 mm / 300 mm	5 mm	5 mm	FR-3011-30		1 x 2 Teeth
234 mm / 350 mm	5 mm	5 mm	FR-3011-35		1 x 2 Teeth
284 mm / 400 mm	5 mm	5 mm	FR-3011-40		1 x 2 Teeth



Grasping Forceps

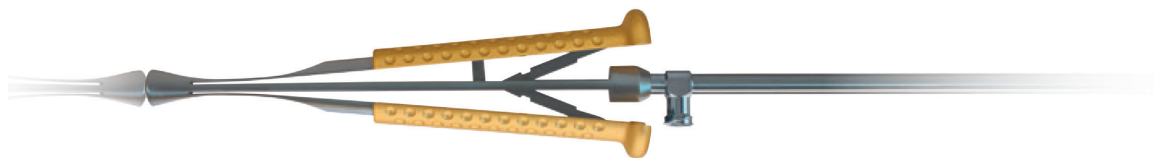

Grasper DeBakey Double Action, Straight 2,8 mm

Working/Total Length	Jaw-Ø	Shaft-Ø	Code	Locking	Tip
184 mm / 300 mm	5 mm	5 mm	FR-3012-30		1 x 2 Teeth
234 mm / 350 mm	5 mm	5 mm	FR-3012-35		1 x 2 Teeth
284 mm / 400 mm	5 mm	5 mm	FR-3012-40		1 x 2 Teeth



Grasper DeBakey Double Action, Angled 45° 2,8 mm

Working/Total Length	Jaw-Ø	Shaft-Ø	Code	Locking	Tip
184 mm / 300 mm	5 mm	5 mm	FR-3013-30		1 x 2 Teeth
234 mm / 350 mm	5 mm	5 mm	FR-3013-35		1 x 2 Teeth
284 mm / 400 mm	5 mm	5 mm	FR-3013-40		1 x 2 Teeth



Grasper DeBakey Double Action, Wide, Straight

Working/Total Length	Jaw-Ø	Shaft-Ø	Code	Locking	Tip
184 mm / 300 mm	5 mm	5 mm	FR-3014-30		1 x 2 Teeth
234 mm / 350 mm	5 mm	5 mm	FR-3014-35		1 x 2 Teeth
284 mm / 400 mm	5 mm	5 mm	FR-3014-40		1 x 2 Teeth



Grasper DeBakey Double Action, Extra Wide, Straight

Working/Total Length	Jaw-Ø	Shaft-Ø	Code	Locking	Tip
193 mm / 300 mm	5 mm	5 mm	FR-3015-30		1 x 2 Teeth
243 mm / 350 mm	5 mm	5 mm	FR-3015-35		1 x 2 Teeth
293 mm / 400 mm	5 mm	5 mm	FR-3015-40		1 x 2 Teeth



Grasping Forceps

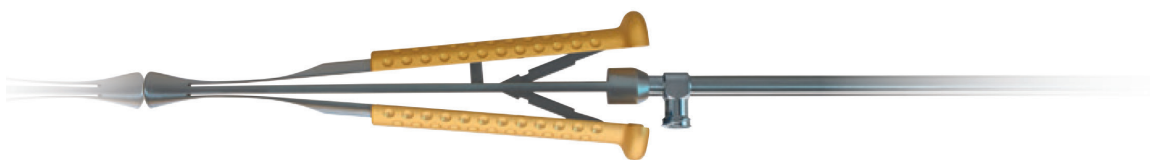

Resano Grasper Single Action, Straight

Working/Total Length	Jaw-Ø	Shaft-Ø	Code	Locking	Tip
184 mm / 300 mm	5 mm	5 mm	FR-3016-30		
234 mm / 350 mm	5 mm	5 mm	FR-3016-35		
284 mm / 400 mm	5 mm	5 mm	FR-3016-40		



Resano Grasper Double Action, Straight

Working/Total Length	Jaw-Ø	Shaft-Ø	Code	Locking	Tip
184 mm / 300 mm	5 mm	5 mm	FR-3017-30		
234 mm / 350 mm	5 mm	5 mm	FR-3017-35		
284 mm / 400 mm	5 mm	5 mm	FR-3017-40		



Resano Grasper Double Action, Straight With Lock

Working/Total Length	Jaw-Ø	Shaft-Ø	Code	Locking	Tip
184 mm / 300 mm	5 mm	5 mm	FR-3018-30	☼	
234 mm / 350 mm	5 mm	5 mm	FR-3018-35	☼	
284 mm / 400 mm	5 mm	5 mm	FR-3018-40	☼	



Russian Grasper Double Action, Straight

Working/Total Length	Jaw-Ø	Shaft-Ø	Code	Locking	Tip
184 mm / 300 mm	5 mm	5 mm	FR-3019-30		
234 mm / 350 mm	5 mm	5 mm	FR-3019-35		
284 mm / 400 mm	5 mm	5 mm	FR-3019-40		



Grasping Forceps

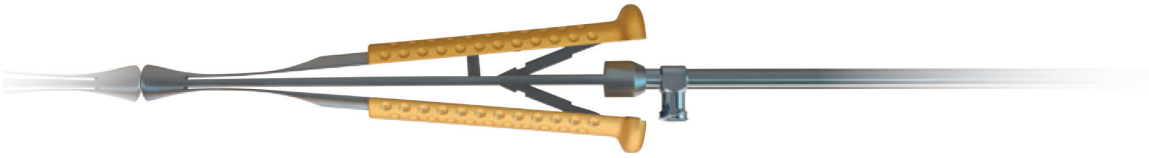

Russian Grasper Double Action, Angled 30°

Working/Total Length	Jaw-Ø	Shaft-Ø	Code	Locking	Tip
184 mm / 300 mm	5 mm	5 mm	FR-3020-30		
234 mm / 350 mm	5 mm	5 mm	FR-3020-35		
284 mm / 400 mm	5 mm	5 mm	FR-3020-400		



Cup-Shaped Forceps Single Action, Oval

Working/Total Length	Jaw-Ø	Shaft-Ø	Code	Locking	Tip
161 mm / 300 mm	3.5 mm	3.4 mm	FR-3021-30		
221 mm / 350 mm	3.5 mm	3.4 mm	FR-3021-35		
271 mm / 400 mm	3.5 mm	3.4 mm	FR-3021-40		



Cup-Shaped Forceps Single Action, Oval

Working/Total Length	Jaw-Ø	Shaft-Ø	Code	Locking	Tip
174 mm / 300 mm	5 mm	5 mm	FR-3022-30		
224 mm / 350 mm	5 mm	5 mm	FR-3022-35		
274 mm / 400 mm	5 mm	5 mm	FR-3022-40		



Cup-Shaped Forceps Single Action, Oval Upwards 30°

Working/Total Length	Jaw-Ø	Shaft-Ø	Code	Locking	Tip
174 mm / 300 mm	5 mm	5 mm	FR-3023-30		
224 mm / 350 mm	5 mm	5 mm	FR-3023-35		
274 mm / 400 mm	5 mm	5 mm	FR-3023-40		



Needle Holders



Needle Holder Single Action, Straight

Working/Total Length	Jaw-Ø	Shaft-Ø	Code	Locking	Tip
161 mm / 300 mm	2.7 mm	2.7 mm	FR-4000-30	☒	TC-Insert
221 mm / 350 mm	2.7 mm	2.7 mm	FR-4000-35	☒	TC-Insert
271 mm / 400 mm	2.7 mm	2.7 mm	FR-4000-40	☒	TC-Insert



Needle Holder Single Action, Curved Left

Working/Total Length	Jaw-Ø	Shaft-Ø	Code	Locking	Tip
161 mm / 300 mm	2.7 mm	2.7 mm	FR-4001-30	☒	TC-Insert
221 mm / 350 mm	2.7 mm	2.7 mm	FR-4001-35	☒	TC-Insert
271 mm / 400 mm	2.7 mm	2.7 mm	FR-4001-40	☒	TC-Insert



Needle Holder Single Action, Straight

Working/Total Length	Jaw-Ø	Shaft-Ø	Code	Locking	Tip
161 mm / 300 mm	3.5 mm	3.4 mm	FR-4002-30	☒	TC-Insert
221 mm / 350 mm	3.5 mm	3.4 mm	FR-4002-35	☒	TC-Insert
271 mm / 400 mm	3.5 mm	3.4 mm	FR-4002-40	☒	TC-Insert



Needle Holder Single Action, Curved Left

Working/Total Length	Jaw-Ø	Shaft-Ø	Code	Locking	Tip
161 mm / 300 mm	3.5 mm	3.4 mm	FR-4003-30	☒	TC-Insert
221 mm / 350 mm	3.5 mm	3.4 mm	FR-4003-35	☒	TC-Insert
271 mm / 400 mm	3.5 mm	3.4 mm	FR-4003-40	☒	TC-Insert



Needle Holders



Needle Holder Single Action, Curved Right

Working/Total Length	Jaw-Ø	Shaft-Ø	Code	Locking	Tip
161 mm / 300 mm	3.5 mm	3.4 mm	FR-4004-30	☒	TC-Insert
221 mm / 350 mm	3.5 mm	3.4 mm	FR-4004-35	☒	TC-Insert
271 mm / 400 mm	3.5 mm	3.4 mm	FR-4004-40	☒	TC-Insert



Needle Holder Single Action, Straight

Working/Total Length	Jaw-Ø	Shaft-Ø	Code	Locking	Tip
174 mm / 300 mm	5 mm	5 mm	FR-4005-30	☒	TC-Insert
224 mm / 350 mm	5 mm	5 mm	FR-4005-35	☒	TC-Insert
274 mm / 400 mm	5 mm	5 mm	FR-4005-40	☒	TC-Insert



Needle Holder Single Action, Curved Left

Working/Total Length	Jaw-Ø	Shaft-Ø	Code	Locking	Tip
174 mm / 300 mm	5 mm	5 mm	FR-4006-30	☒	TC-Insert
224 mm / 350 mm	5 mm	5 mm	FR-4006-35	☒	TC-Insert
274 mm / 400 mm	5 mm	5 mm	FR-4006-40	☒	TC-Insert



Needle Holder Single Action, Curved Right

Working/Total Length	Jaw-Ø	Shaft-Ø	Code	Locking	Tip
174 mm / 300 mm	5 mm	5 mm	FR-4007-30	☒	TC-Insert
224 mm / 350 mm	5 mm	5 mm	FR-4007-35	☒	TC-Insert
274 mm / 400 mm	5 mm	5 mm	FR-4007-40	☒	TC-Insert



Needle Holders



Needle Holder Single Action, Angled 45°

Working/Total Length	Jaw-Ø	Shaft-Ø	Code	Locking	Tip
184 mm / 300 mm	5 mm	5 mm	FR-4008-30	☒	TC-Insert
234 mm / 350 mm	5 mm	5 mm	FR-4008-35	☒	TC-Insert
284 mm / 400 mm	5 mm	5 mm	FR-4008-40	☒	TC-Insert



Needle Holder Ryder Single Action, Straight

Working/Total Length	Jaw-Ø	Shaft-Ø	Code	Locking	Tip
174 mm / 300 mm	5 mm	5 mm	FR-4009-30	☒	TC-Insert
224 mm / 350 mm	5 mm	5 mm	FR-4009-35	☒	TC-Insert
274 mm / 400 mm	5 mm	5 mm	FR-4009-40	☒	TC-Insert



Needle Holder Colvin Single Action, Straight

Working/Total Length	Jaw-Ø	Shaft-Ø	Code	Locking	Tip
174 mm / 300 mm	5 mm	5 mm	FR-4010-30	☒	TC-Insert
224 mm / 350 mm	5 mm	5 mm	FR-4010-35	☒	TC-Insert
274 mm / 400 mm	5 mm	5 mm	FR-4010-40	☒	TC-Insert



Needle Holder Colvin Single Action, Curved Left

Working/Total Length	Jaw-Ø	Shaft-Ø	Code	Locking	Tip
174 mm / 300 mm	5 mm	5 mm	FR-4011-30	☒	TC-Insert
224 mm / 350 mm	5 mm	5 mm	FR-4011-35	☒	TC-Insert
274 mm / 400 mm	5 mm	5 mm	FR-4011-40	☒	TC-Insert



Needle Holders



Needle Holder Single Action, Curved Left

Working/Total Length	Jaw-Ø	Shaft-Ø	Code	Locking	Tip
171 mm / 300 mm	5 mm	3.4 mm	FR-4012-30	☒	TC-Insert
231 mm / 350 mm	5 mm	3.4 mm	FR-4012-35	☒	TC-Insert
281 mm / 400 mm	5 mm	3.4 mm	FR-4012-40	☒	TC-Insert



Needle Holder Single Action, Straight Heavy

Working/Total Length	Jaw-Ø	Shaft-Ø	Code	Locking	Tip
174 mm / 300 mm	6 mm	5 mm	FR-4013-30	☒	TC-Insert
224 mm / 350 mm	6 mm	5 mm	FR-4013-35	☒	TC-Insert
274 mm / 400 mm	6 mm	5 mm	FR-4013-40	☒	TC-Insert



Needle Holder Single Action, Curved Left Heavy

Working/Total Length	Jaw-Ø	Shaft-Ø	Code	Locking	Tip
174 mm / 300 mm	6 mm	5 mm	FR-4014-30	☒	TC-Insert
224 mm / 350 mm	6 mm	5 mm	FR-4014-35	☒	TC-Insert
274 mm / 400 mm	6 mm	5 mm	FR-4014-40	☒	TC-Insert



Needle Holder Double Action Straight 1,5 mm

Working/Total Length	Jaw-Ø	Shaft-Ø	Code	Locking	Tip
174 mm / 300 mm	5 mm	5 mm	FR-4015-30	☒	TC-Insert
224 mm / 350 mm	5 mm	5 mm	FR-4015-35	☒	TC-Insert
274 mm / 400 mm	5 mm	5 mm	FR-4015-40	☒	TC-Insert



Needle Holders



Needle Holder Single Action, Curved Left

Working/Total Length	Jaw-Ø	Shaft-Ø	Code	Locking	Tip
161 mm / 300 mm	2.7 mm	2.7 mm	FR-4016-30	☼	TC-Coated
221 mm / 350 mm	2.7 mm	2.7 mm	FR-4016-35	☼	TC-Coated
271 mm / 400 mm	2.7 mm	2.7 mm	FR-4016-40	☼	TC-Coated



Needle Holder Single Action, Straight

Working/Total Length	Jaw-Ø	Shaft-Ø	Code	Locking	Tip
161 mm / 300 mm	3.5 mm	3.4 mm	FR-4017-30	☼	TC-Coated
221 mm / 350 mm	3.5 mm	3.4 mm	FR-4017-35	☼	TC-Coated
271 mm / 400 mm	3.5 mm	3.4 mm	FR-4017-40	☼	TC-Coated



Needle Holder Single Action, Curved Left

Working/Total Length	Jaw-Ø	Shaft-Ø	Code	Locking	Tip
161 mm / 300 mm	3.5 mm	3.4 mm	FR-4018-30	☼	TC-Coated
221 mm / 350 mm	3.5 mm	3.4 mm	FR-4018-35	☼	TC-Coated
271 mm / 400 mm	3.5 mm	3.4 mm	FR-4018-40	☼	TC-Coated



Needle Holder Single Action, Curved Right, 2 x 8,5 mm

Working/Total Length	Jaw-Ø	Shaft-Ø	Code	Locking	Tip
161 mm / 300 mm	3.5 mm	3.4 mm	FR-4019-30	☼	TC-Coated
221 mm / 350 mm	3.5 mm	3.4 mm	FR-4019-35	☼	TC-Coated
271 mm / 400 mm	3.5 mm	3.4 mm	FR-4019-40	☼	TC-Coated



Needle Holders



Needle Holder Ryder Single Action, Straight

Working/Total Length	Jaw-Ø	Shaft-Ø	Code	Locking	Tip
161 mm / 300 mm	3.5 mm	3.4 mm	FR-4020-30	☒	TC-Coated
221 mm / 350 mm	3.5 mm	3.4 mm	FR-4020-35	☒	TC-Coated
271 mm / 400 mm	3.5 mm	3.4 mm	FR-4020-40	☒	TC-Coated



Needle Holder Single Action, Straight

Working/Total Length	Jaw-Ø	Shaft-Ø	Code	Locking	Tip
174 mm / 300 mm	5 mm	5 mm	FR-4021-30	☒	TC-Coated
224 mm / 350 mm	5 mm	5 mm	FR-4021-35	☒	TC-Coated
274 mm / 400 mm	5 mm	5 mm	FR-4021-40	☒	TC-Coated



Needle Holder Single Action, Curved Left

Working/Total Length	Jaw-Ø	Shaft-Ø	Code	Locking	Tip
174 mm / 300 mm	5 mm	5 mm	FR-4022-30	☒	TC-Coated
224 mm / 350 mm	5 mm	5 mm	FR-4022-35	☒	TC-Coated
274 mm / 400 mm	5 mm	5 mm	FR-4022-40	☒	TC-Coated



Needle Holder Single Action, Curved Right

Working/Total Length	Jaw-Ø	Shaft-Ø	Code	Locking	Tip
174 mm / 300 mm	5 mm	5 mm	FR-4023-30	☒	TC-Coated
224 mm / 350 mm	5 mm	5 mm	FR-4023-35	☒	TC-Coated
274 mm / 400 mm	5 mm	5 mm	FR-4023-40	☒	TC-Coated



Needle Holders

Needle Holder Single Action, Curved Right 2 x 10 mm

Working/Total Length	Jaw-Ø	Shaft-Ø	Code	Locking	Tip
174 mm / 300 mm	5 mm	5 mm	FR-4024-30	☒	TC-Coated
224 mm / 350 mm	5 mm	5 mm	FR-4024-35	☒	TC-Coated
274 mm / 400 mm	5 mm	5 mm	FR-4024-40	☒	TC-Coated

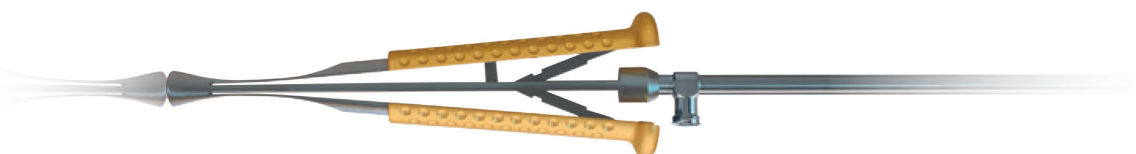
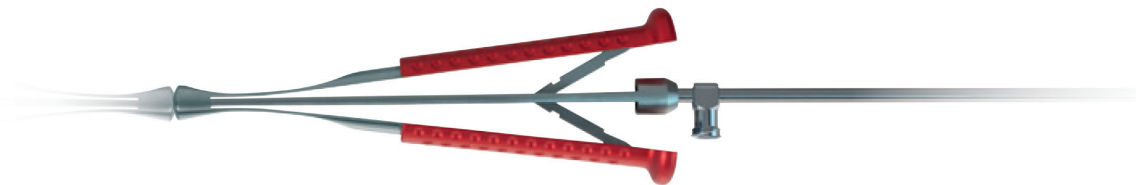
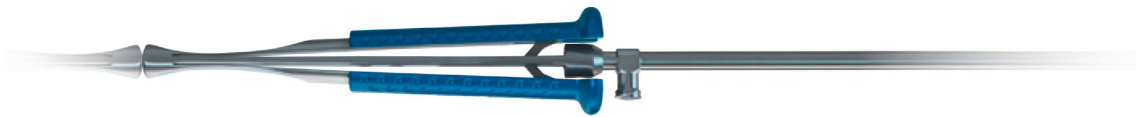

Special Instruments



Knot Pusher

Working/Total Length	Jaw-Ø	Shaft-Ø	Code	Locking	Tip
161 mm / 300 mm	3.5 mm	3.4 mm	FR-5000-30		
221 mm / 350 mm	3.5 mm	3.4 mm	FR-5000-35		
271 mm / 400 mm	3.5 mm	3.4 mm	FR-5000-40		



Knot Pusher with Lock

Working/Total Length	Jaw-Ø	Shaft-Ø	Code	Locking	Tip
161 mm / 300 mm	3.5 mm	3.4 mm	FR-5001-30	☒	
221 mm / 350 mm	3.5 mm	3.4 mm	FR-5001-35	☒	
271 mm / 400 mm	3.5 mm	3.4 mm	FR-5001-40	☒	



Knot Pusher Reverse Acting

Working/Total Length	Jaw-Ø	Shaft-Ø	Code	Locking	Tip
161 mm / 300 mm	3.5 mm	3.4 mm	FR-5002-30		
221 mm / 350 mm	3.5 mm	3.4 mm	FR-5002-35		
271 mm / 400 mm	3.5 mm	3.4 mm	FR-5002-40		



Knot Pusher

Working/Total Length	Jaw-Ø	Shaft-Ø	Code	Locking	Tip
184 mm / 300 mm	5 mm	5 mm	FR-5003-30		
234 mm / 350 mm	5 mm	5 mm	FR-5003-35		
284 mm / 400 mm	5 mm	5 mm	FR-5003-40		



Special Instruments



Knot Pusher with Lock

Working/Total Length	Jaw-Ø	Shaft-Ø	Code	Locking	Tip
184 mm 300 mm	5 mm	5 mm	FR-5004-30	☒	
234 mm 350 mm	5 mm	5 mm	FR-5004-35	☒	
284 mm 400 mm	5 mm	5 mm	FR-5004-40	☒	



Knot Pusher Reverse Acting

Working/Total Length	Jaw-Ø	Shaft-Ø	Code	Locking	Tip
184 mm 300 mm	5 mm	5 mm	FR-5005-30		
234 mm 350 mm	5 mm	5 mm	FR-5005-35		
284 mm 400 mm	5 mm	5 mm	FR-5005-40		



Knot Pusher Short Jaw

Working/Total Length	Jaw-Ø	Shaft-Ø	Code	Locking	Tip
184 mm 300 mm	5 mm	5 mm	FR-5006-30		
234 mm 350 mm	5 mm	5 mm	FR-5006-35		
284 mm 400 mm	5 mm	5 mm	FR-5006-40		



Knot Pusher Short Jaw with Lock

Working/Total Length	Jaw-Ø	Shaft-Ø	Code	Locking	Tip
184 mm 300 mm	5 mm	5 mm	FR-5007-30	☒	
234 mm 350 mm	5 mm	5 mm	FR-5007-35	☒	
284 mm 400 mm	5 mm	5 mm	FR-5007-40	☒	



Special Instruments

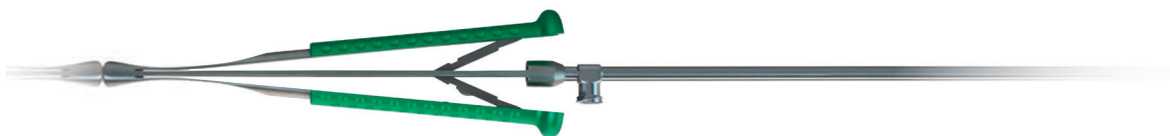

Knot Pusher Short Jaw Reverse Acting

Working/Total Length	Jaw-Ø	Shaft-Ø	Code	Locking	Tip
184 mm / 300 mm	5 mm	5 mm	FR-5008-30		
234 mm / 350 mm	5 mm	5 mm	FR-5008-35		
284 mm / 400 mm	5 mm	5 mm	FR-5008-40		



Forceps Smooth Jaw, Single Action

Working/Total Length	Jaw-Ø	Shaft-Ø	Code	Locking	Tip
184 mm / 300 mm	3.5 mm	5 mm	FR-5009-30		
234 mm / 350 mm	3.5 mm	5 mm	FR-5009-35		
284 mm / 400 mm	3.5 mm	5 mm	FR-5009-40		



Grasper Forceps Single Action, Upwards 45°, Mouse Teeth 2 x 1 mm

Working/Total Length	Jaw-Ø	Shaft-Ø	Code	Locking	Tip
161 mm / 300 mm	3.5 mm	3.4 mm	FR-5010-30		
221 mm / 350 mm	3.5 mm	3.4 mm	FR-5010-35		
271 mm / 400 mm	3.5 mm	3.4 mm	FR-5010-40		



Dissecting Forceps Double Action

Working/Total Length	Jaw-Ø	Shaft-Ø	Code	Locking	Tip
193 mm / 300 mm	5 mm	5 mm	FR-5011-30		
243 mm / 350 mm	5 mm	5 mm	FR-5011-35		
293 mm / 400 mm	5 mm	5 mm	FR-5011-40		



Special Instruments



Maryland Forceps Double Action

Working/Total Length	Jaw-Ø	Shaft-Ø	Code	Locking	Tip
184 mm / 300 mm	5 mm	5 mm	FR-5012-30		
234 mm / 350 mm	5 mm	5 mm	FR-5012-35		
284 mm / 400 mm	5 mm	5 mm	FR-5012-40		



Leaflet Forceps, Curved Slightly

Working/Total Length	Jaw-Ø	Shaft-Ø	Code	Locking	Tip
193 mm / 300 mm	5 mm	5 mm	FR-5013-30		
243 mm / 350 mm	5 mm	5 mm	FR-5013-35		
293 mm / 400 mm	5 mm	5 mm	FR-5013-40		



Leaflet Forceps, Curved Strongly

Working/Total Length	Jaw-Ø	Shaft-Ø	Code	Locking	Tip
193 mm / 300 mm	5 mm	5 mm	FR-5014-30		
243 mm / 350 mm	5 mm	5 mm	FR-5014-35		
293 mm / 400 mm	5 mm	5 mm	FR-5014-40		



Leaflet Forceps, Curved Slightly

Working/Total Length	Jaw-Ø	Shaft-Ø	Code	Locking	Tip
193 mm / 300 mm	5 mm	5 mm	FR-5015-30	☒	
243 mm / 350 mm	5 mm	5 mm	FR-5015-35	☒	
293 mm / 400 mm	5 mm	5 mm	FR-5015-40	☒	



MICS & VATS INSTRUMENTS

Special Instruments



Leaflet Forceps, Curved Strongly

Working/Total Length	Jaw-Ø	Shaft-Ø	Code	Locking	Tip
193 mm / 300 mm	5 mm	5 mm	FR-5016-30	☒	
243 mm / 350 mm	5 mm	5 mm	FR-5016-35	☒	
293 mm / 400 mm	5 mm	5 mm	FR-5016-40	☒	



Clip Forceps for Horizon Small Double Action, Yellow

Working/Total Length	Jaw-Ø	Shaft-Ø	Code	Locking	Tip
177 mm / 300 mm	5 mm	5 mm	FR-5017-30		
235 mm / 350 mm	5 mm	5 mm	FR-5017-35		
285 mm / 400 mm	5 mm	5 mm	FR-5017-40		



3 Test clips must be provided per instrument when ordering

Clip Forceps for Horizon Small Double Action, Red

Working/Total Length	Jaw-Ø	Shaft-Ø	Code	Locking	Tip
177 mm / 300 mm	5 mm	5 mm	FR-5018-30		
235 mm / 350 mm	5 mm	5 mm	FR-5018-35		
285 mm / 400 mm	5 mm	5 mm	FR-5018-40		



3 Test clips must be provided per instrument when ordering

Clip Forceps for Horizon Medium Double Action, Blue

Working/Total Length	Jaw-Ø	Shaft-Ø	Code	Locking	Tip
177 mm / 300 mm	5 mm	5 mm	FR-5019-30		
235 mm / 350 mm	5 mm	5 mm	FR-5019-35		
285 mm / 400 mm	5 mm	5 mm	FR-5019-40		



3 Test clips must be provided per instrument when ordering

Special Instruments

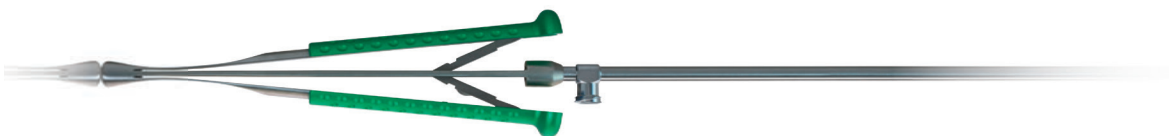

Clip Forceps for Vitalitec Small Double Action, Yellow

Working/Total Length	Jaw-Ø	Shaft-Ø	Code	Locking	Tip
177 mm / 300 mm	5 mm	5 mm	FR-5020-30		
235 mm / 350 mm	5 mm	5 mm	FR-5020-35		
285 mm / 400 mm	5 mm	5 mm	FR-5020-40		



3 Test clips must be provided per instrument when ordering

Clip Forceps for Vitalitec Medium Double Action, Blue

Working/Total Length	Jaw-Ø	Shaft-Ø	Code	Locking	Tip
177 mm / 300 mm	5 mm	5 mm	FR-5021-30		
235 mm / 350 mm	5 mm	5 mm	FR-5021-35		
285 mm / 400 mm	5 mm	5 mm	FR-5021-40		



3 Test clips must be provided per instrument when ordering

Clip Forceps for Nexus Small Double Action, Yellow

Working/Total Length	Jaw-Ø	Shaft-Ø	Code	Locking	Tip
177 mm / 300 mm	5 mm	5 mm	FR-5022-30		
235 mm / 350 mm	5 mm	5 mm	FR-5022-35		
285 mm / 400 mm	5 mm	5 mm	FR-5022-40		



3 Test clips must be provided per instrument when ordering

Chest Tube Passers



Description	Length	Code
Chest Tube Passers 2.8 mm	24 cm	FR-8100-24

Chest Tube Passers



Description	Length	Code
Chest Tube Passers 2.8 mm	36 cm	FR-8100-36





MICS & VATS INSTRUMENTS

MICS Instruments



VATS Instruments



VATS Scissors



Description

Metzenbaum Scissors Slightly Curved TC 10 mm Shaft
 Metzenbaum Scissors Slightly Curved TC 10 mm Shaft

Total Length

33 cm
 37 cm

Code

FR-8101-33
 FR-8101-37

VATS Scissors



Description

Metzenbaum Scissors Slightly Curved TC 10 mm Shaft
 Metzenbaum Scissors Slightly Curved TC 10 mm Shaft

Total Length

32 cm
 36 cm

Code

FR-8102-32
 FR-8102-36



VATS Scissors

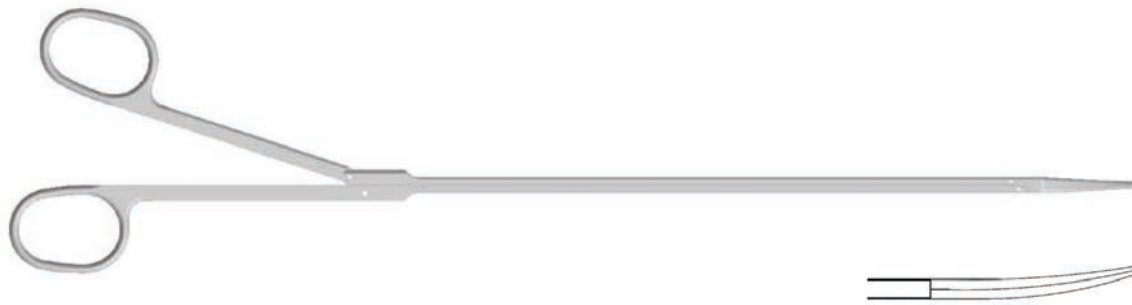

Description

Metzenbaum Scissors Curved Super Cut TC 5 mm Shaft

Total Length

36 cm

Code

FR-8103-36

VATS Scissors



Description

Metzenbaum Fino Scissors Curved Super Cut TC 7 mm Shaft

Total Length

36 cm

Code

FR-8104-36

VATS Scissors



Description

Metzenbaum Short Jaw Scissors Curved Super Cut TC 7 mm Shaft

Total Length

29 cm

Code

FR-8105-29

VATS Scissors



Description

Metzenbaum Short Jaw Scissors Curved Super Cut TC 5 mm Shaft
 Metzenbaum Short Jaw Scissors Curved Super Cut TC 7 mm Shaft
 Metzenbaum Short Jaw Scissors Curved Super Cut TC 7 mm Shaft

Total Length

29 cm
 32 cm
 36 cm

Code

FR-8106-29
 FR-8106-32
 FR-8106-36

VATS Needle Holder

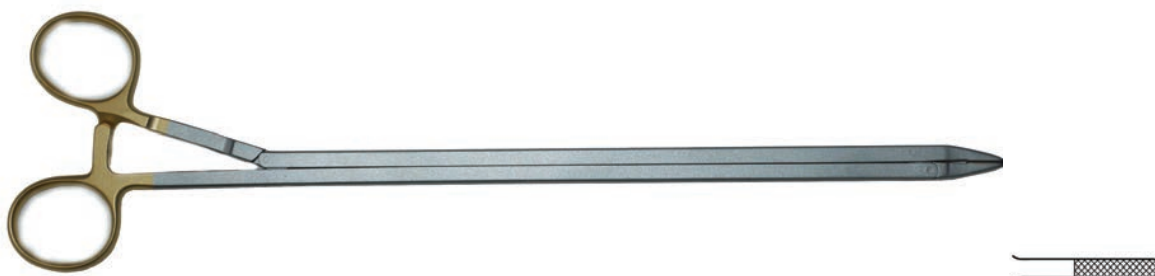

Description

VATS Needle Holder Straight TC

Jaw

2 mm

Shaft

10 mm

Total Length

29 cm

Code

FR-8107-29

VATS Needle Holder

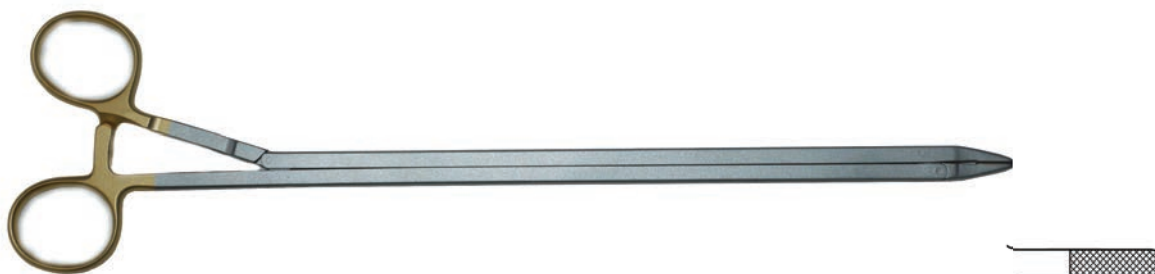

Description

VATS Needle Holder Straight TC

Jaw

3 mm

Shaft

10 mm

Total Length

29 cm

Code

FR-8108-29

MICS & VATS INSTRUMENTS

VATS Needle Holder

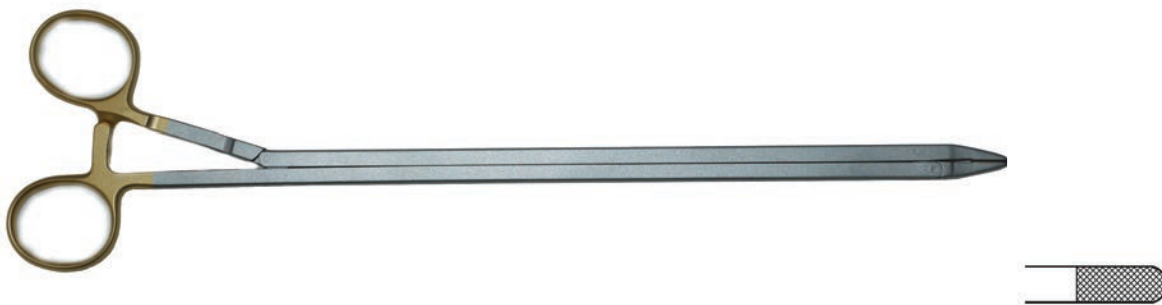

Description	Jaw	Shaft	Total Length	Code
VATS Needle Holder Straight TC	4 mm	10 mm	29 cm	FR-8110-29
VATS Needle Holder Straight TC	4 mm	7 mm	34 cm	FR-8110-34

VATS Needle Holder

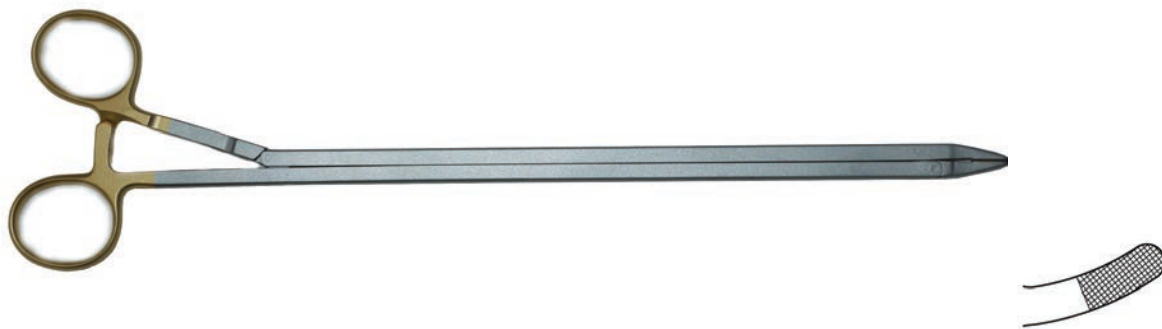

Description	Jaw	Shaft	Total Length	Code
VATS Needle Holder Curved TC	4 mm	7 mm	29 cm	FR-8111-29
VATS Needle Holder Curved TC	4 mm	7 mm	34 cm	FR-8111-34

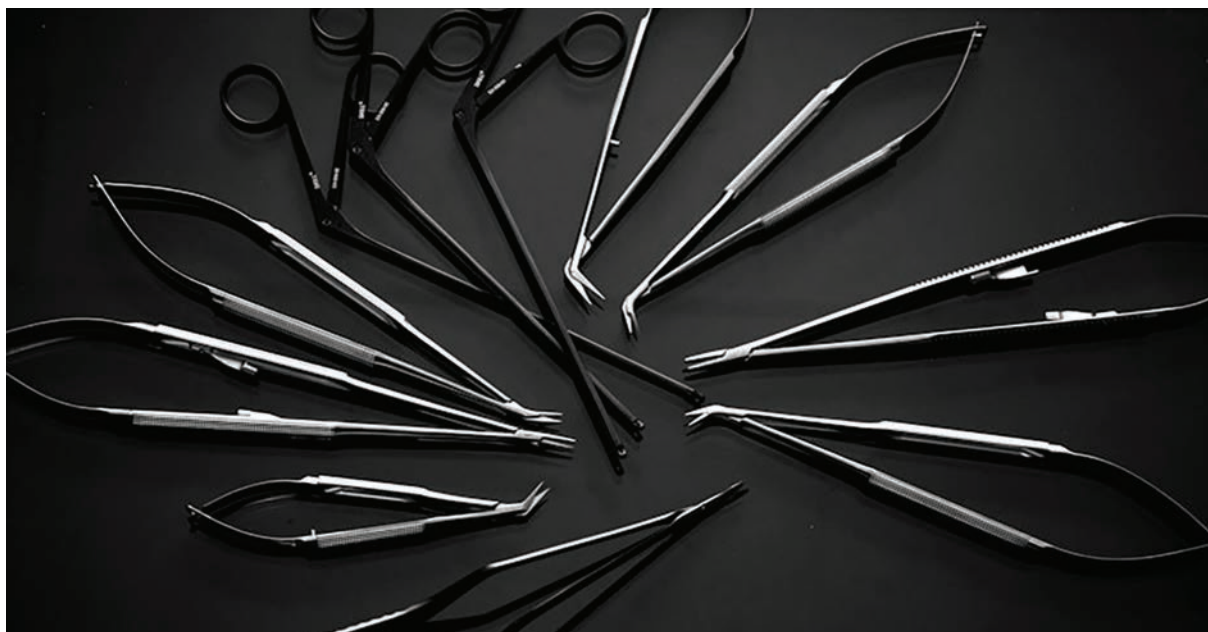

VATS DeBakey Clamp

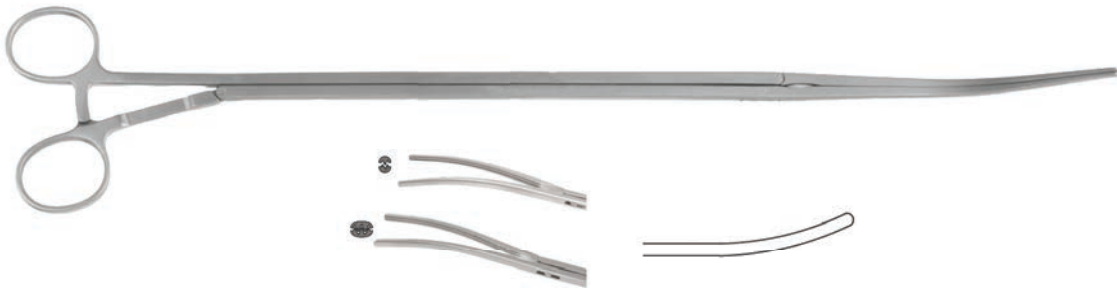

Description

VATS DeBakey Clamp, 1 x 2 DeBakey
 VATS DeBakey Clamp, 2 x 3 DeBakey

Jaw

82 mm
 82 mm

Shaft

10 mm
 10 mm

Total Length

29 cm
 29 cm

Code

FR-8301-29
 FR-8302-29

VATS DeBakey Clamp

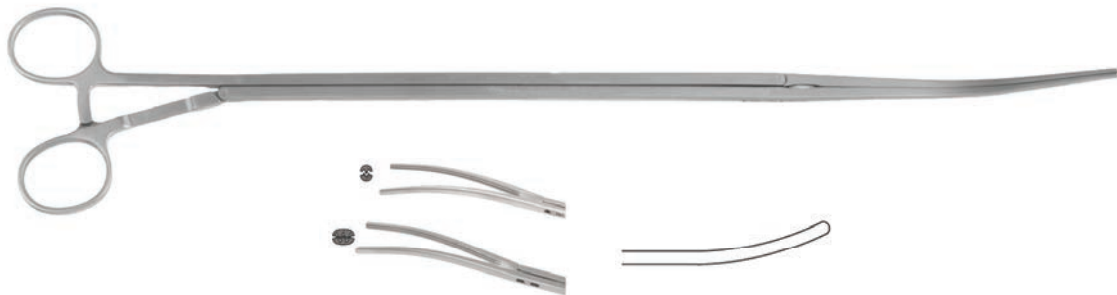

Description

VATS DeBakey Clamp, 1 x 2 DeBakey
 VATS DeBakey Clamp, 2 x 3 DeBakey

Jaw

62 mm
 62 mm

Shaft

10 mm
 10 mm

Total Length

33 cm
 29 cm

Code

FR-8303-33
 FR-8304-29

VATS DeBakey Clamp

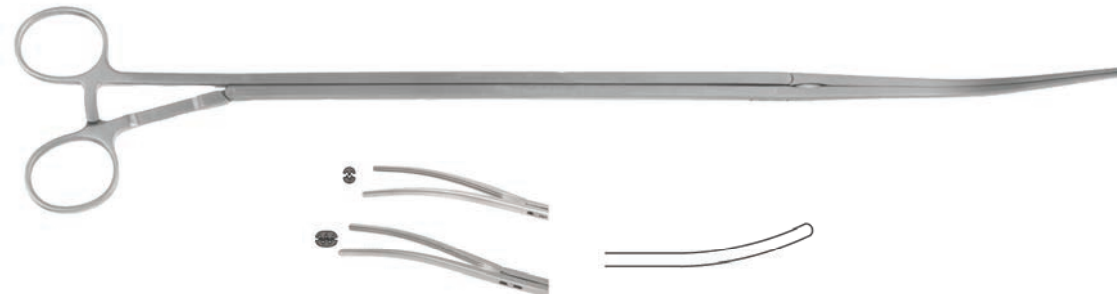

Description

VATS DeBakey Clamp, 1 x 2 DeBakey
 VATS DeBakey Clamp, 2 x 3 DeBakey

Jaw

92 mm
 92 mm

Shaft

10 mm
 10 mm

Total Length

36 cm
 36 cm

Code

FR-8305-36
 FR-8306-36

VATS DeBakey Clamp

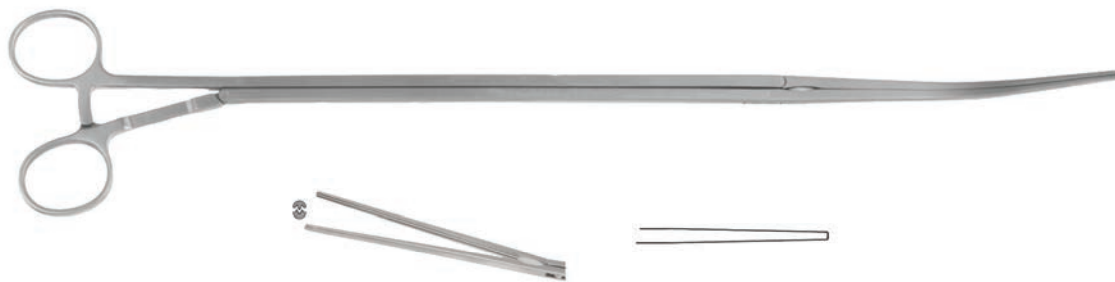

Description	Jaw	Shaft	Total Length	Code
VATS DeBakey Clamp Straight	110 mm	10 mm	38 cm	FR-9301-38

VATS DeBakey Clamp

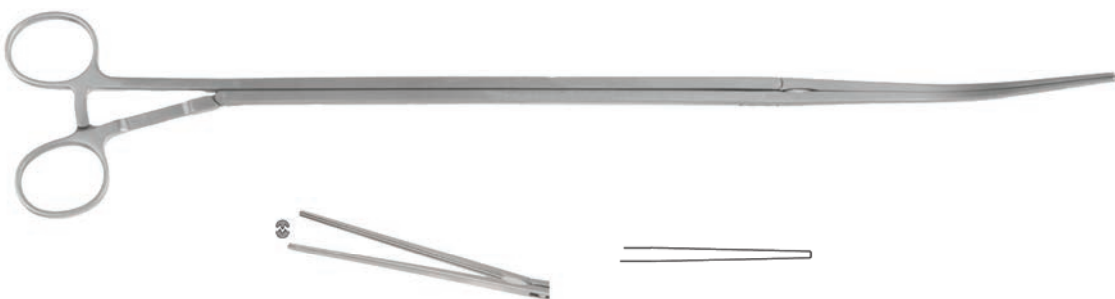

Description	Jaw	Shaft	Total Length	Code
VATS DeBakey Clamp Curved	110 mm	10 mm	38 cm	FR-9302-38

VATS DeBakey Clamp

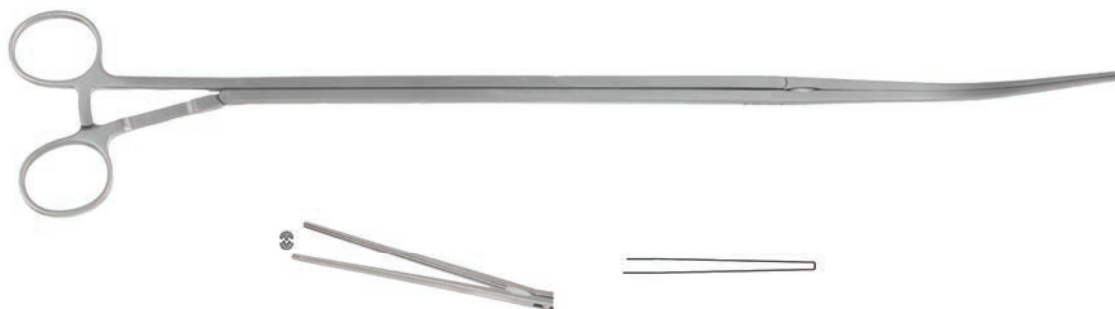

Description	Jaw	Shaft	Total Length	Code
VATS DeBakey Clamp Fully Curved	105 mm	10 mm	37 cm	FR-9303-37

VATS Harken and Satinsky Clamp

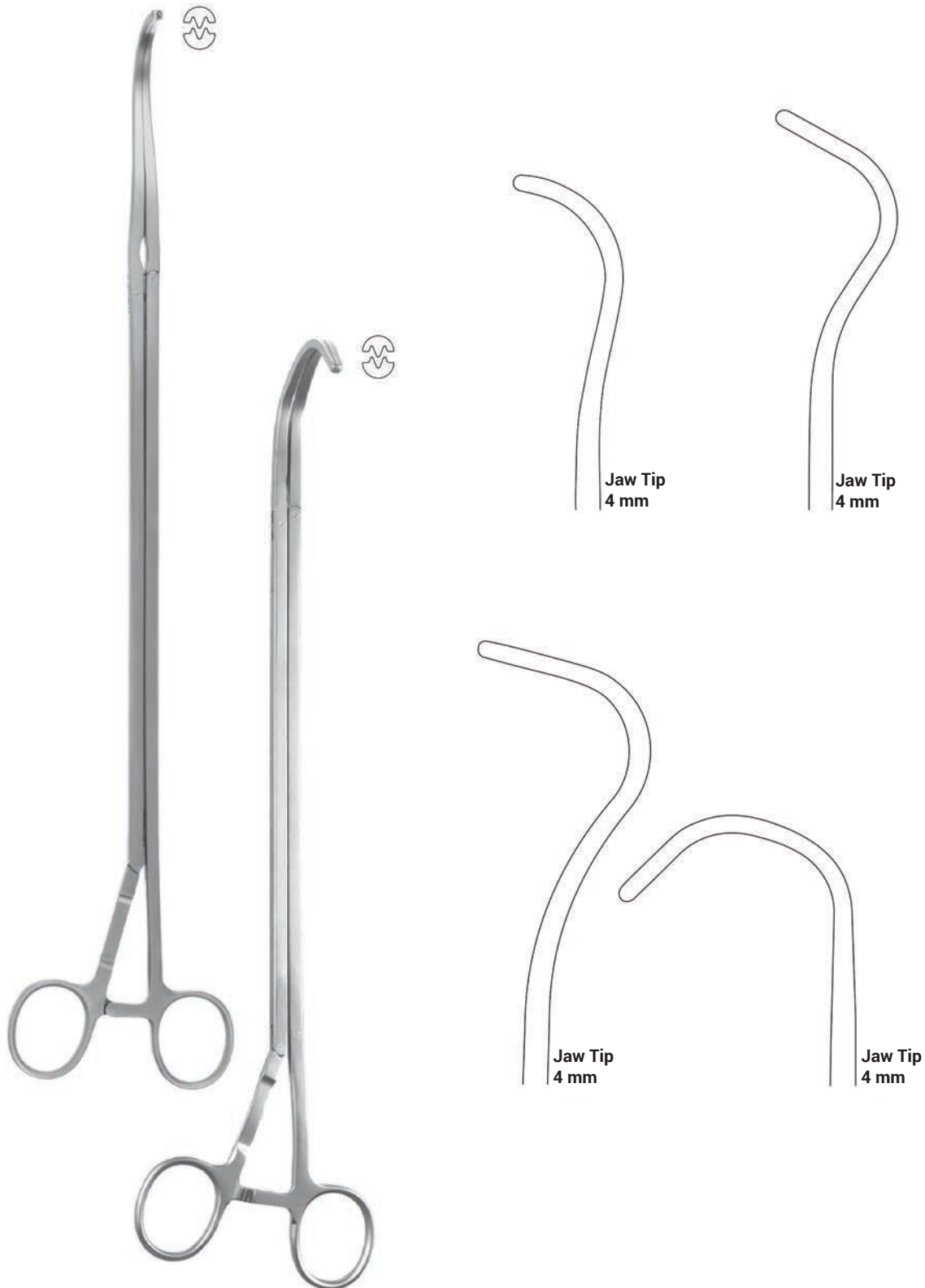

Description	Shaft with Ratchet	Total Length	Code
VATS Harken DeBakey Clamp Strongly Curved	10 mm	35 cm	FR-9304-35
VATS Harken DeBakey Clamp Strongly Curved	10 mm	29 cm	FR-9305-29

VATS Harken and Satinsky Clamp

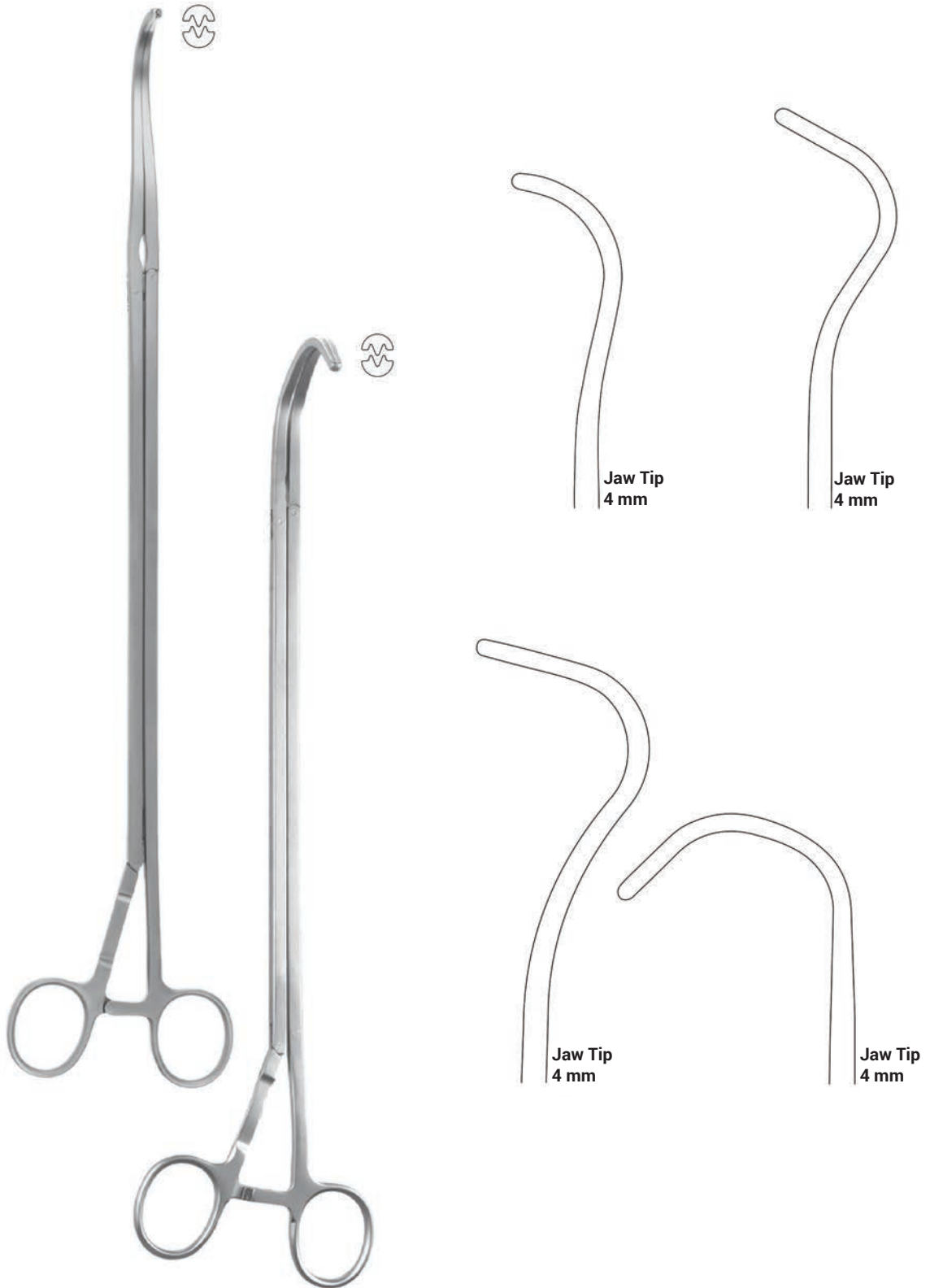

Description	Shaft with Ratchet	Total Length	Code
VATS Harken DeBakey Clamp Slightly Curved	10 mm	35 cm	FR-9306-35
VATS Harken DeBakey Clamp Slightly Curved	10 mm	35 cm	FR-9307-35

VATS Harken and Satinsky Clamp

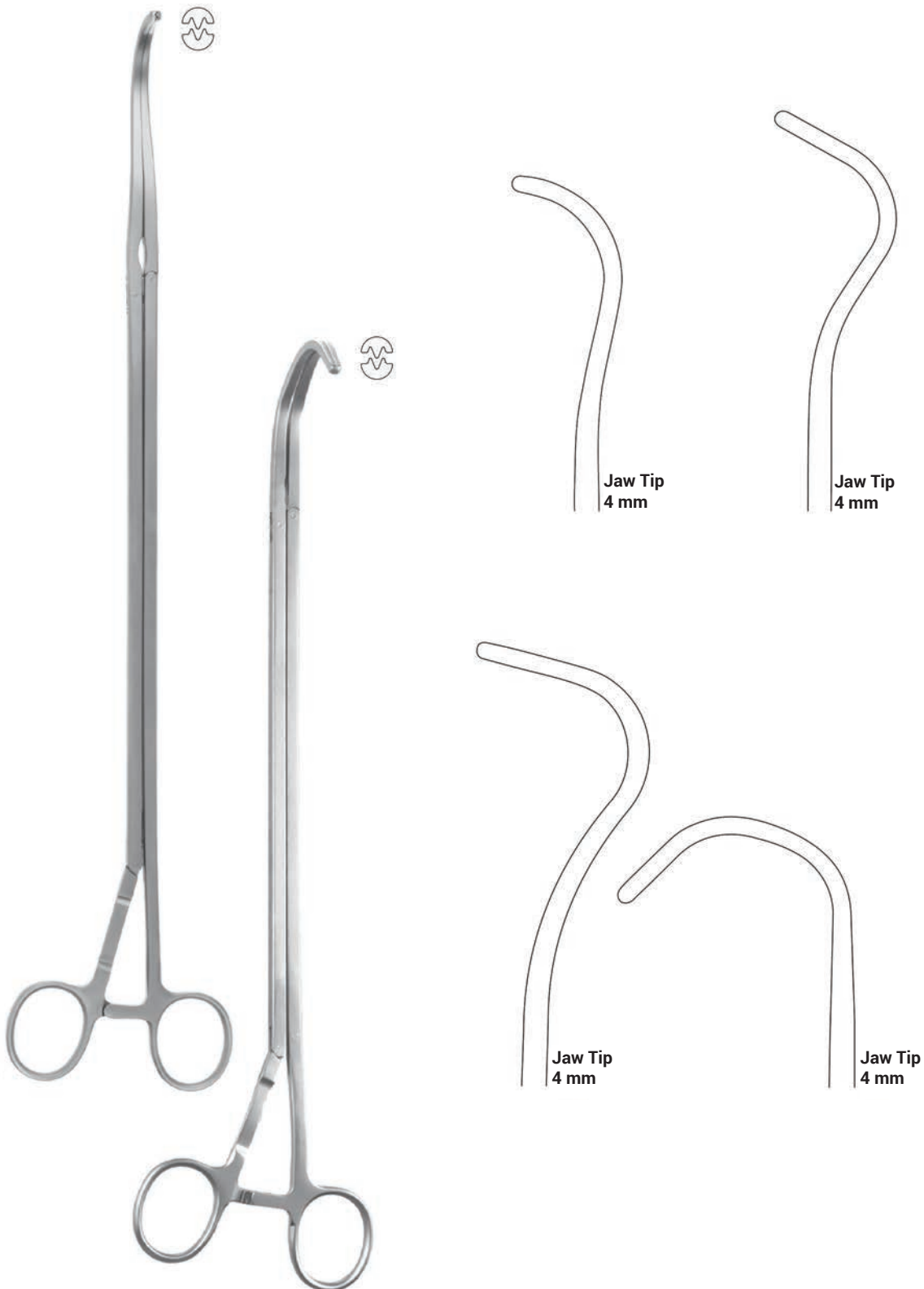

MICS & VATS INSTRUMENTS

Description

VATS Harken DeBakey Clamp
Strongly Curved

Shaft with Ratchet

10 mm

Total Length

36 cm

Code

FR-9308-36

MICS & VATS INSTRUMENTS

VATS Harken and Satinsky Clamp

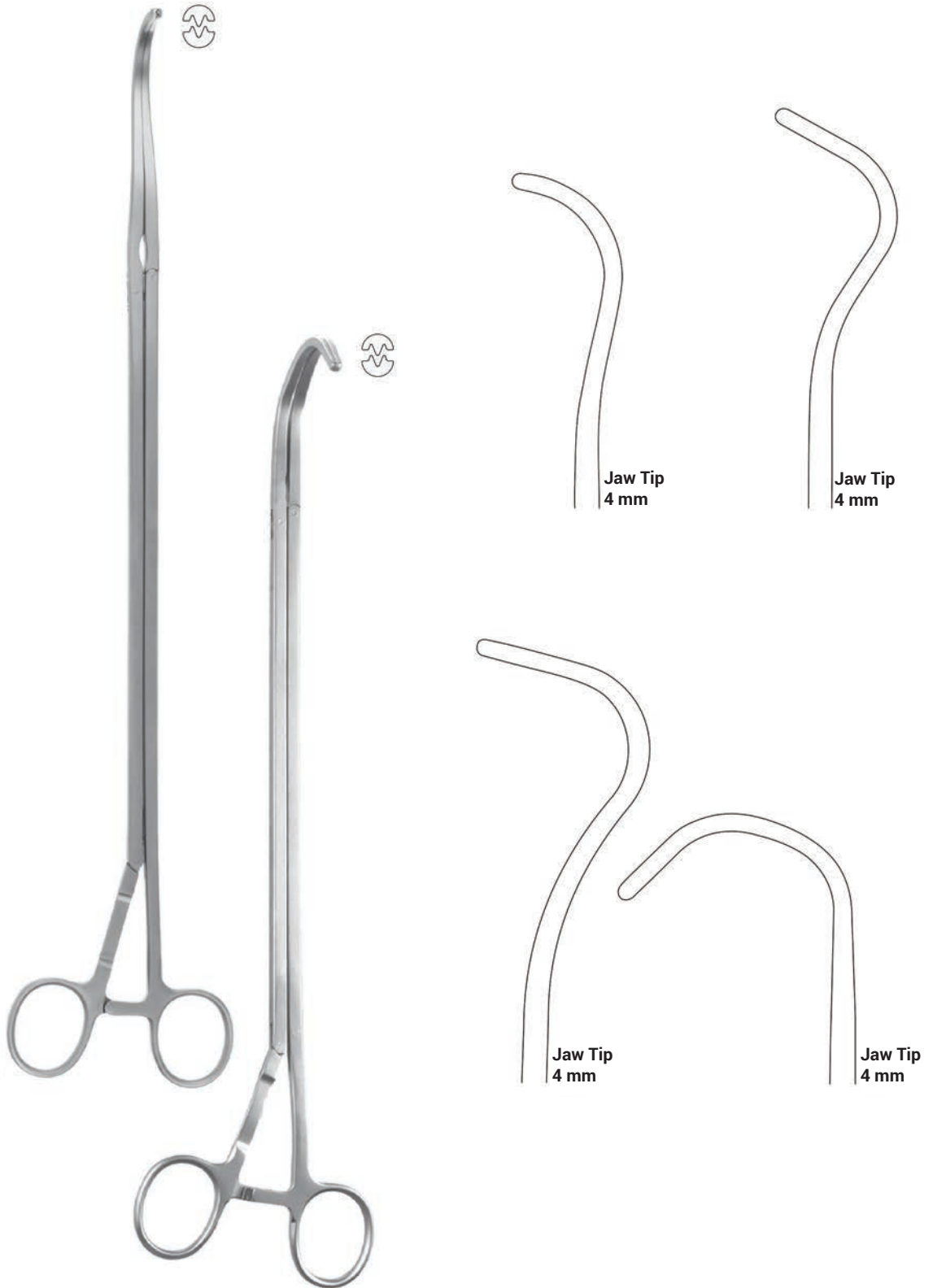

Description	Jaw	Shaft with Ratchet	Total Length	Code
VATS Harken DeBakey Clamp Satinsky	3 mm	10 mm	32 cm	FR-9309-32

VATS Foerster Lung Grasping Clamp

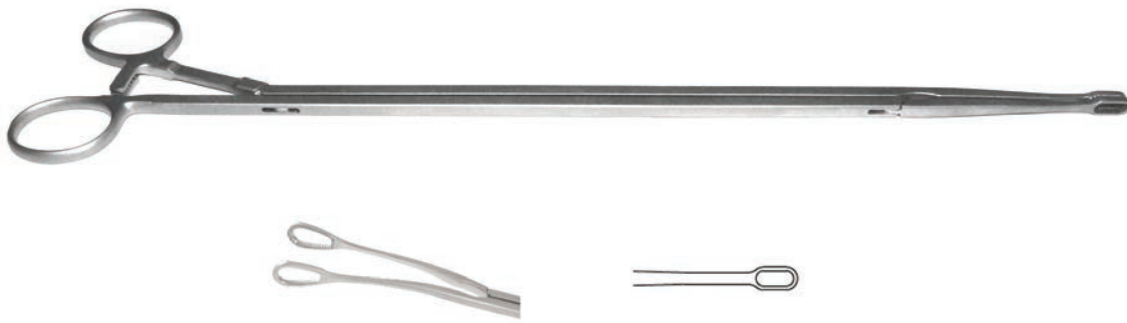

Description	Jaw	Shaft with Ratchet	Total Length	Code
Foerster Lung Grasping Forceps Straight	6 mm	5 mm	34 cm	FR-9312-34
Foerster Lung Grasping Forceps Straight	10 mm	6 mm	34 cm	FR-9313-34



VATS Foerster Lung Grasping Clamp



Description	Jaw	Shaft with Ratchet	Total Length	Code
Foerster Lung Grasping Forceps Curved	7 mm	6 mm	34 cm	FR-9314-34
Foerster Lung Grasping Forceps Curved	10 mm	6 mm	34 cm	FR-9315-34

VATS Foerster Lung Grasping Clamp

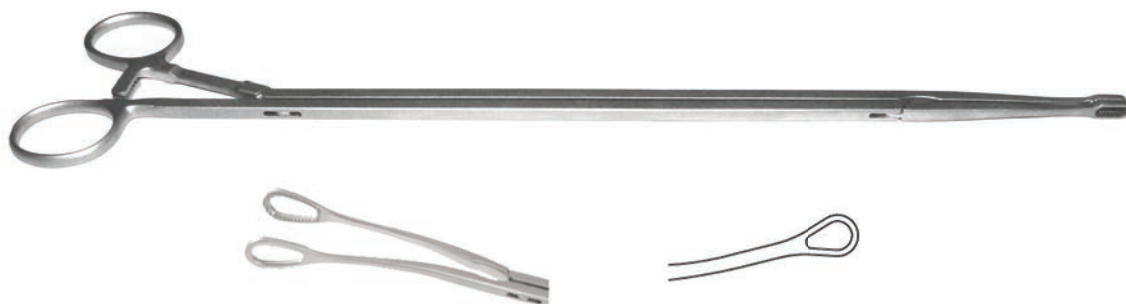

Description	Jaw	Shaft with Ratchet	Total Length	Code
Foerster Lung Grasping Forceps Curved	10 mm	7 mm	34 cm	FR-9316-34

VATS Foerster Lung Grasping Clamp



Description	Jaw	Shaft with Ratchet	Total Length	Code
Foerster Lung Grasping Forceps Curved	10 mm	10 mm	35 cm	FR-9317-35

VATS Foerster Lung Grasping Clamp

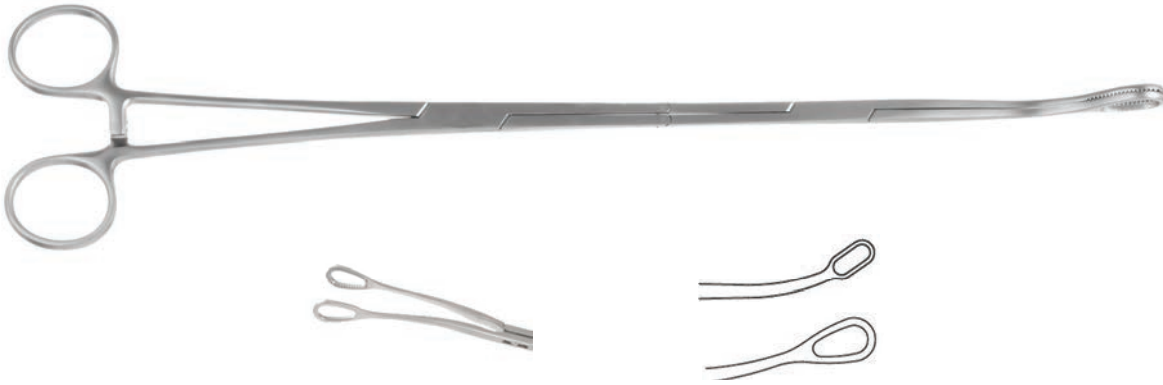

Description	Jaw	Shaft with Ratchet	Total Length	Code
Foerster Lung Grasping Forceps Curved	13 mm	10 mm	35 cm	FR-9318-35

VATS Foerster Lung Grasping Clamp

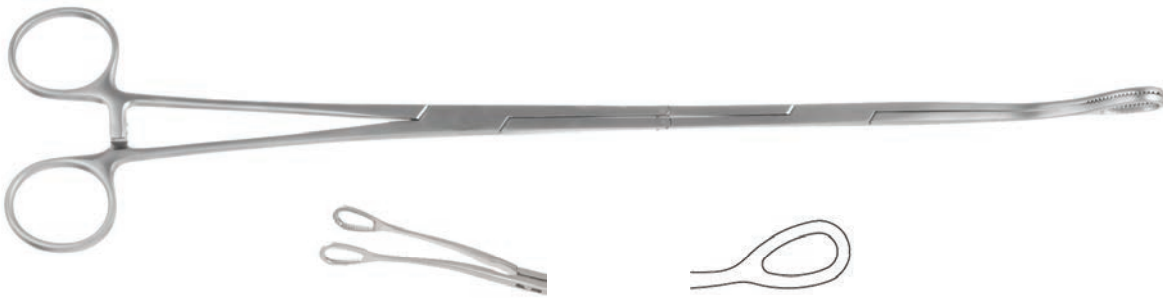

Description	Jaw	Shaft with Ratchet	Total Length	Code
Foerster Lung Grasping Forceps Curved	20 mm	10 mm	35 cm	FR-9319-35

VATS Dissector Clamp

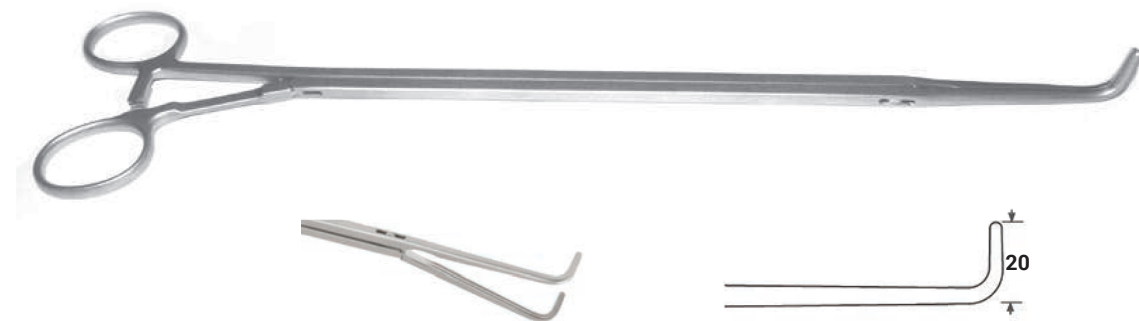

Description	Jaw	Shaft with Ratchet	Total Length	Code
VATS DeBakey 90 Degree Angle Clamp	20 mm	10 mm	33 cm	FR-9320-33

VATS Dissector Clamp

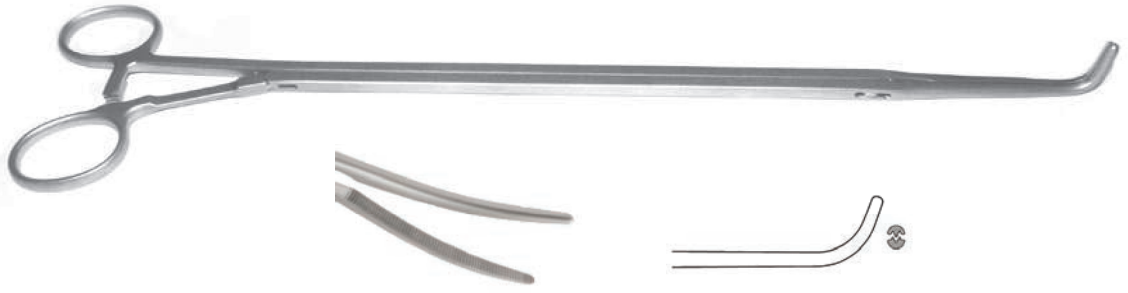

Description	Shaft with Ratchet	Total Length	Code
VATS Dennis DeBakey Clamp Curved	10 mm	33 cm	FR-9321-33

VATS Dissector Clamp

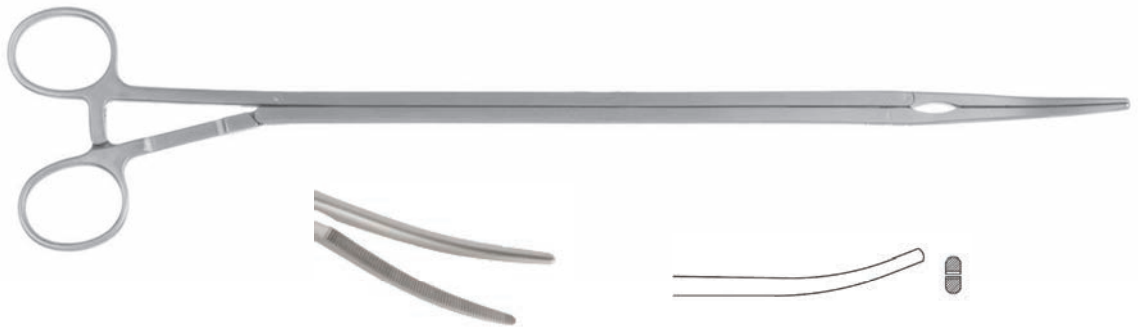

Description	Shaft with Ratchet	Total Length	Code
VATS Dennis DeBakey Clamp Curved	7 mm	33 cm	FR-9322-33

VATS Dissector Clamp



Description	Jaw	Shaft with Ratchet	Total Length	Code
VATS Glasmann Allis Clamp Curved	8.2 mm	10 mm	34 cm	FR-9323-34



VATS Dissector Clamp



Description	Jaw	Shaft with Ratchet	Total Length	Code
VATS Glasmann Allis Clamp Curved	7.2 mm	10 mm	34 cm	FR-9324-34

VATS Duval Lung Grasping Clamp

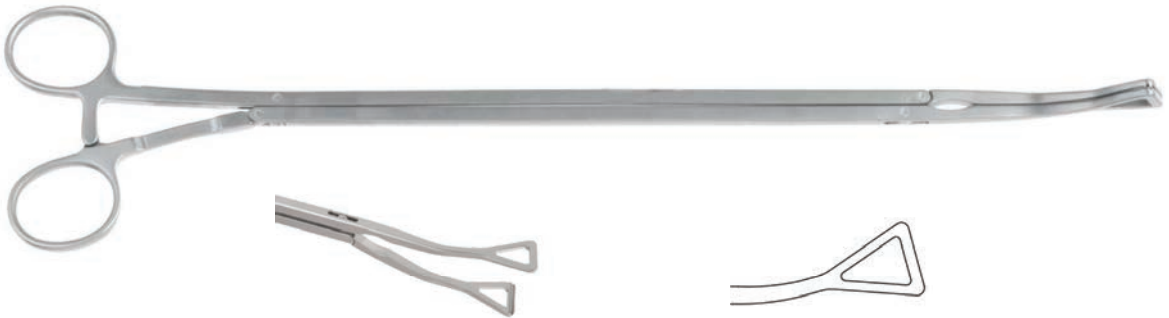

Description	Jaw	Shaft with Ratchet	Total Length	Code
Duval Lung Grasping Forceps	14 mm	10 mm	33 cm	FR-9310-33

VATS Duval Lung Grasping Clamp

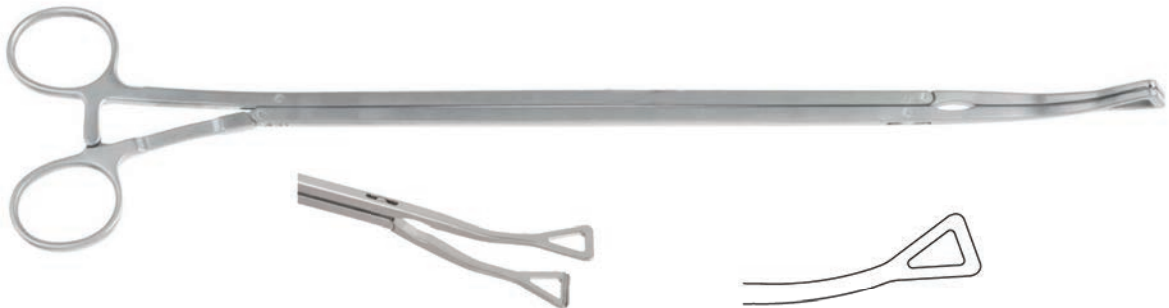

Description	Jaw	Shaft with Ratchet	Total Length	Code
Duval Lung Grasping Forceps	20 mm	10 mm	33 cm	FR-9311-33

Valve Extra Long Rongeurs

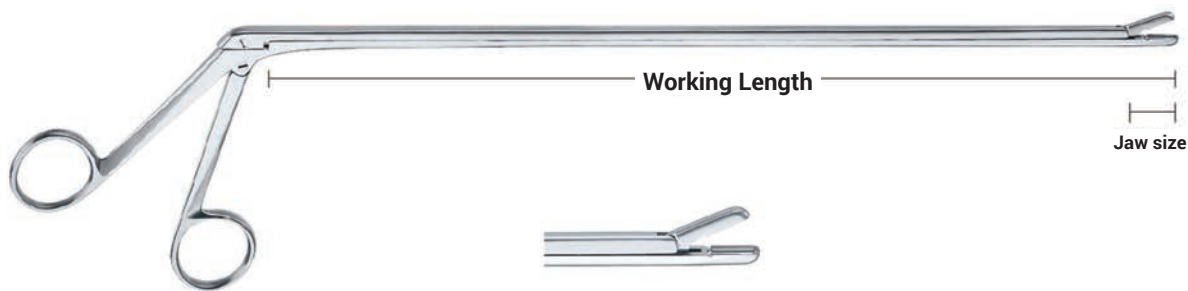

Description	Jaw	Total Length	Code
Valve Extra Long Rongeur	3 x 10 mm	33 cm	FR-9901-33

Valve Extra Long Rongeurs

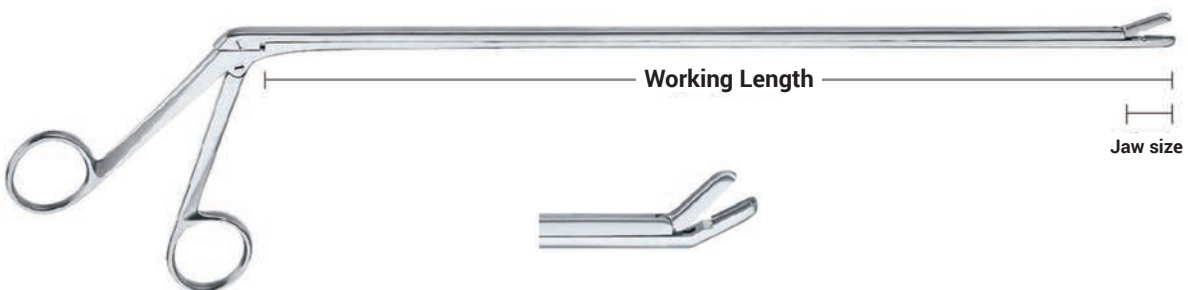

Description	Jaw	Total Length	Code
Valve Extra Long Rongeur Curved Upwards	3 x 10 mm	33 cm	FR-9902-33

Dissector Sliding Clamp

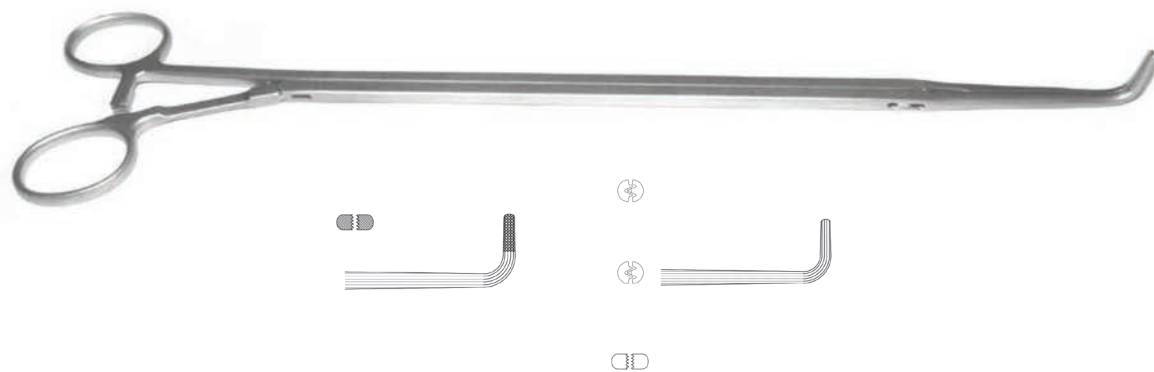

Description	Shaft with Ratchet	Working Length	Total Length	Code
Dissector Sliding Clamp	10 mm	24 cm	33 cm	FR-9903-33
Dissector Sliding Clamp	10 mm	25 cm	33 cm	FR-9904-33
Dissector Sliding Clamp	10 mm	25 cm	34 cm	FR-9905-34

Dissector Sliding Clamp

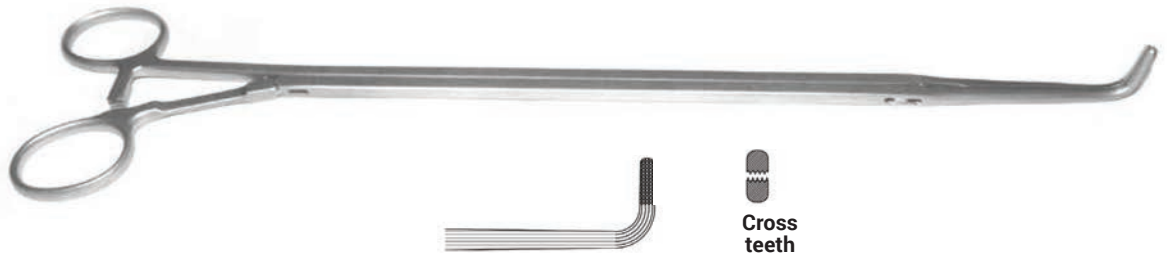

Description	Shaft without Ratchet	Working Length	Total Length	Code
Dissector Sliding Clamp	10 mm	25 cm	34 cm	FR-9906-34

Dissector Sliding Clamp | DeBakey & Dennis

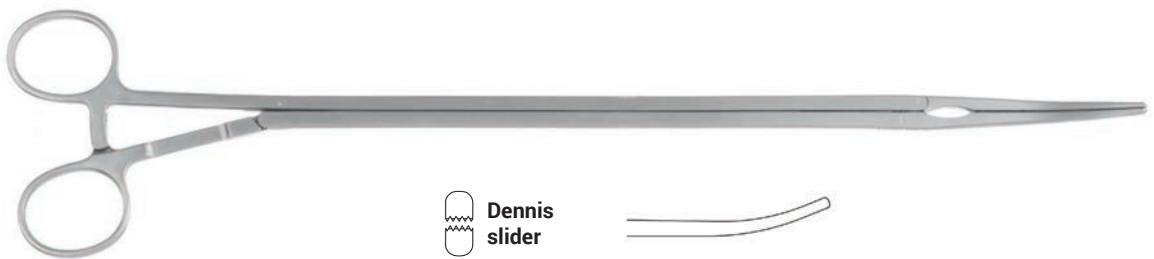

Description	Jaw	Shaft with Ratchet	Working Length	Total Length	Code
Dennis Slider	65 mm	10 mm	24 cm	33 cm	FR-9907-33
Dennis Slider w/o Ratchet	65 mm	10 mm	24 cm	33 cm	FR-9908-33

Dissector Sliding Clamp | DeBakey & Dennis

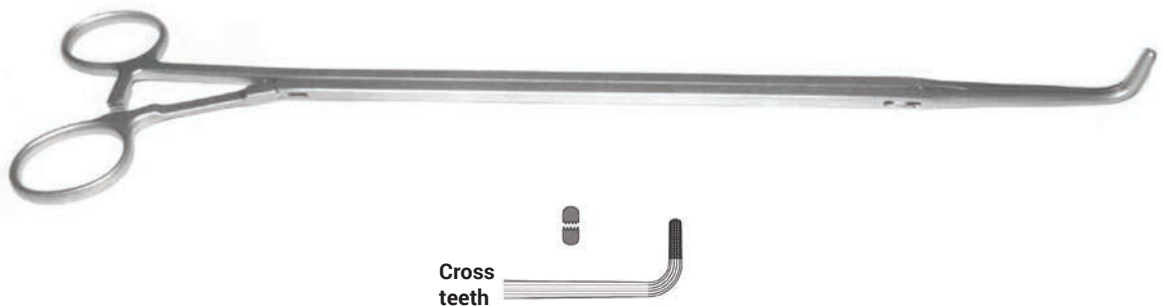

Description	Jaw	Shaft with Ratchet	Working Length	Total Length	Code
Dissector DeBakey Slider	65 mm	10 mm	24 cm	33 cm	FR-9909-33
Dissector DeBakey Slider w/o Ratchet		5 mm	19 cm	29 cm	FR-9910-29

Sliding Scissors Super Cut



Description	Jaw	Without Ratchet	Working Length	Total Length	Code
Sliding Scissors	55 mm	10 mm	25 cm	33 cm	FR-9911-33
Sliding Scissors	55 mm	10 mm	25 cm	36 cm	FR-9912-36

Sliding Scissors Super Cut



Description	Jaw	Without Ratchet	Working Length	Total Length	Code
Sliding Scissors	35 mm	7 mm	19 cm	29 cm	FR-9913-29
Sliding Scissors	35 mm	10 mm	25 cm	36 cm	FR-9914-36
Sliding Scissors	35 mm	10 mm	19 cm	29 cm	FR-9915-29

Sliding Scissors Super Cut

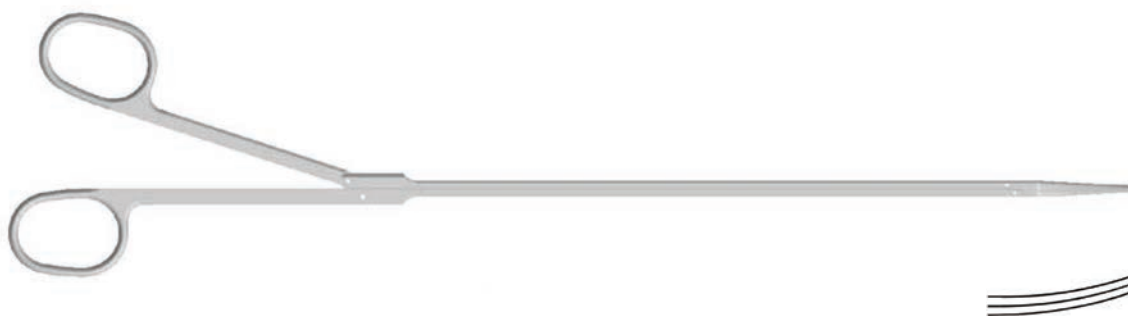

Description	Jaw	Without Ratchet	Working Length	Total Length	Code
Sliding Scissors	35 mm	5 mm	23 cm	35 cm	FR-9916-35
Sliding Scissors	35 mm	5 mm	21 cm	32 cm	FR-9917-32
Sliding Scissors	30 mm	5 mm	19 cm	29 cm	FR-9918-29
Sliding Scissors	12 mm	7 mm	27 cm	38 cm	FR-9919-38

Double Action Grasper Clamp Hallmann



Description	Jaw	Shaft with Ratchet	Working Length	Total Length	Code
Double Action Grasper Clamp Hallmann, Cross Teeth	8 mm		15.1 cm	34 cm	FR-9920-34
Double Action Grasper Clamp Hallmann, Cross Teeth	8 mm		16.8 cm	40 cm	FR-9921-40

Double Action Grasper Clamp Hallmann



Description	Jaw	Shaft with Ratchet	Working length	Total Length	Code
Double Action Grasper Clamp Hallmann, Cross Teeth	8 mm		15.1 cm	34 cm	FR-9922-34
Double Action Grasper Clamp Hallmann, Ø15 mm	8 mm		15.2 cm	38 cm	FR-9923-38

Double Action Scissors



Description	Jaw	Without Ratchet	Working Length	Total Length	Code
Double Action Scissors	73 mm	10 mm	21.4 cm	32 cm	FR-9924-32
Double Action Scissors	73 mm	10 mm	21.4 cm	36 cm	FR-9925-36

Double Action Scissors



Description	Jaw	Without Ratchet	Working Length	Total Length	Code
Double Action Scissors	67 mm	10 mm	20.8 cm	32 cm	FR-9926-32
Double Action Scissors	67 mm	10 mm	20.8 cm	36 cm	FR-9927-36

D'Amico Biopsy Forceps

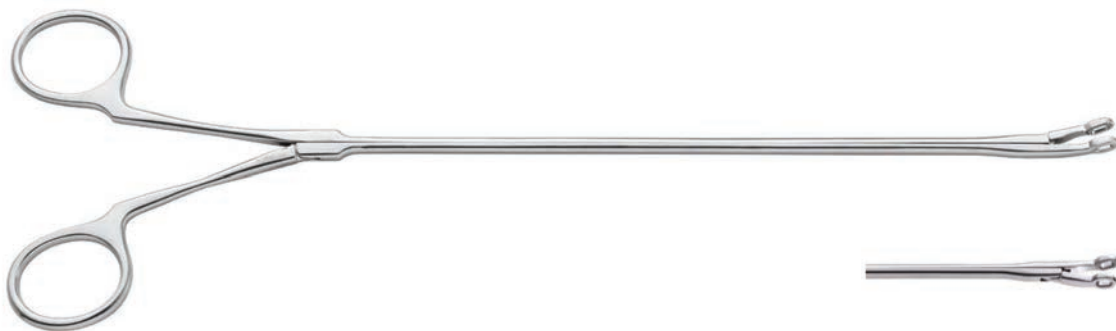

Description	Shaft Thickness	Working Length	Total Length	Code
6 mm Width Oval Ring Jaws Curved with Ratchet	5 mm Tapered to 7 mm	23 cm	33 cm	FR-9928-33

D'Amico Biopsy Forceps

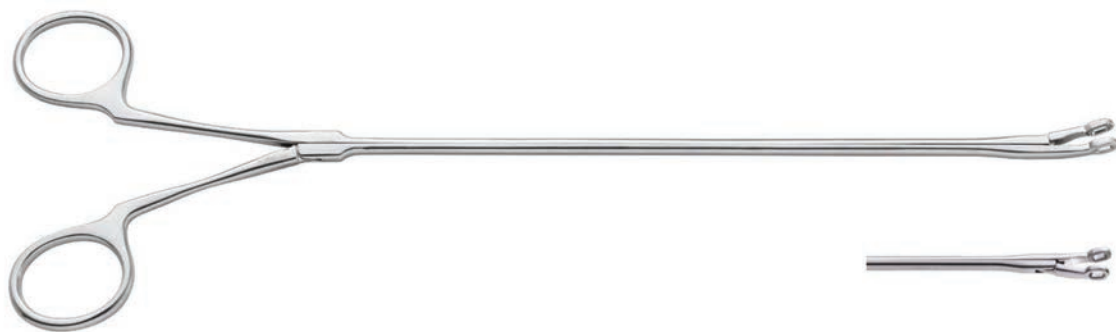

Description	Shaft Thickness	Working Length	Total Length	Code
7 mm Width Oval Ring Jaws Curved with Ratchet	5 mm Tapered to 7 mm	23 cm	33 cm	FR-9930-33

D'Amico Mediastinoscopy Forceps



Description	Shaft Thickness	Working Length	Total Length	Code
6 mm Width Oval Ring Jaws Curved with Ratchet	7 mm	28 cm	38 cm	FR-9932-38
6 mm Width Oval Ring Jaws Curved without Ratchet	7 mm	28 cm	38 cm	FR-9933-38

D'Amico Mediastinoscopy Forceps



Description	Shaft Thickness	Working Length	Total Length	Code
7 mm Width Oval Ring Jaws Curved with Ratchet	7 mm	28 cm	38 cm	FR-9934-38
7 mm Width Oval Ring Jaws Curved without Ratchet	7 mm	28 cm	38 cm	FR-9935-38

Gonzalez-Rivas Lung Grasping Clamp

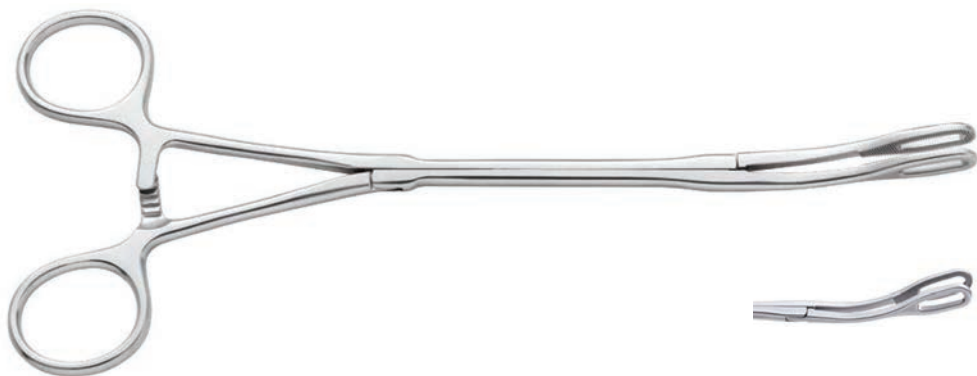

Description	Shaft Thickness	Working Length	Total Length	Code
High Tension Curved Left 20 mm Oval Ring Jaws with Ratchet	7 mm Tapered to 10 mm	15 cm	25 cm	FR-9936-25

Foerster Lung Grasping Clamp

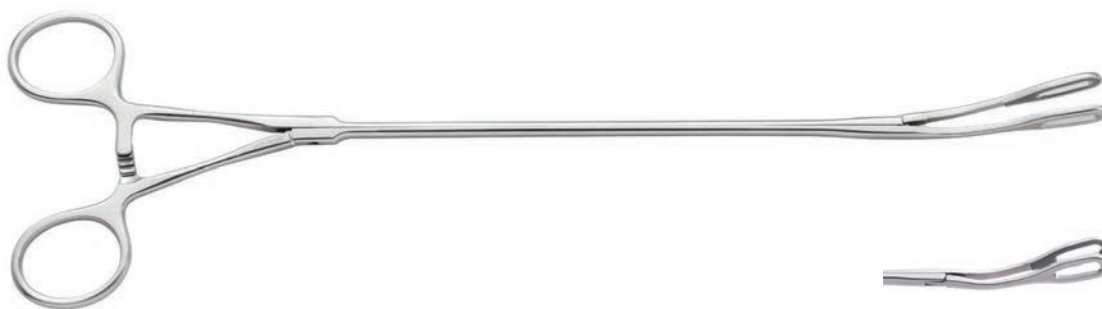

Description

Curved Left 20 mm Oval Ring
Jaws with Ratchet

**Shaft
Thickness**

5 mm Tapered to 7 mm

**Working
Length**

24 cm

**Total
Length**

34 cm

Code

FR-9937-34

Foerster Lung Grasping Clamp



Description

Curved Right Jaws (Left-Hand Style)
12 mm Oval Ring with Ratchet 7 mm

**Shaft
Thickness**

19 cm

**Working
Length**

29 cm

**Total
Length**

FR-9939-29

Curved Left Jaws
12 mm Oval Ring with Ratchet 7 mm

19 cm

29 cm

FR-9940-29

Foerster Lung Grasping Clamp



Description

Curved Left Jaws
12 mm Oval Ring with Ratchet

**Shaft
Thickness**

7 mm

**Working
Length**

24 cm

**Total
Length**

34 cm

Code

FR-9941-34

Node Grasping Clamp



Description	Shaft Thickness	Working Length	Total Length	Code
Straight Jaws 11 mm With Ratchet	5 mm	23 cm	33 cm	FR-9952-33
Curved Jaws 11 mm With Ratchet	5 mm	23 cm	33 cm	FR-9953-33
Curved Jaws 11 mm Without Ratchet	5 mm	23 cm	33 cm	FR-9954-33

Node Grasping Clamp



Description	Shaft Thickness	Working Length	Total Length	Code
Curved Jaws 11 mm With Ratchet	5 mm Tapered to 7 mm	32 cm	42 cm	FR-9955-42
Curved Jaws 11 mm Without Ratchet	5 mm Tapered to 7 mm	32 cm	42 cm	FR-9956-42

Khan Decortication Grasper

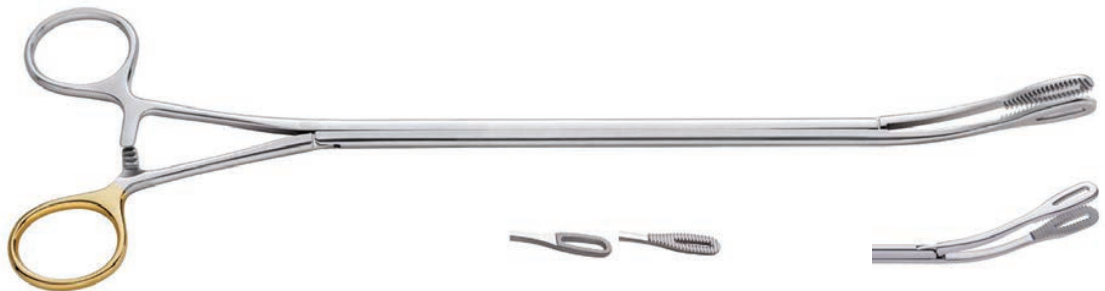

Description	Shaft Thickness	Working Length	Total Length	Code
Enhanced Serrations 20 mm Left Curved Jaws with Ratchet	10 mm	24 cm	34 cm	FR-9957-34

Gonzalez-Rivas Dissector

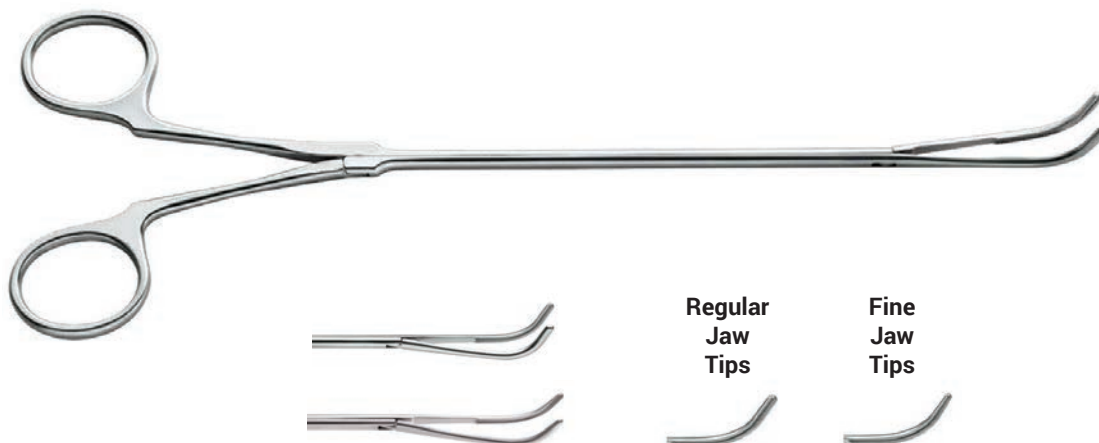

Description	Shaft Thickness	Working Length	Total Length	Code
Mixer-style 1 x 2 DeBakey Jaws with Ratchet	5 mm	19 cm	29 cm	FR-9958-29
Mixer-style 1 x 2 DeBakey Jaws without Ratchet	5 mm	19 cm	29 cm	FR-9959-29
Mixer-style 1 x 2 DeBakey Jaws Fine Tips with Ratchet	5 mm	19 cm	29 cm	FR-9960-29
Mixer-style 1 x 2 DeBakey Jaws Fine Tips without Ratchet	5 mm	19 cm	29 cm	FR-9961-29

Gonzalez-Rivas Dissector

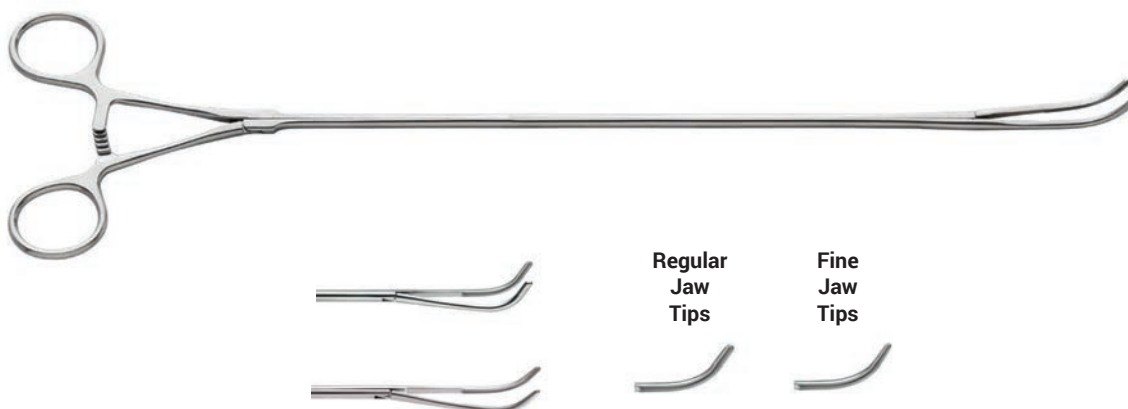

Description	Shaft Thickness	Working Length	Total Length	Code
Mixer-style 1 x 2 DeBakey Jaws with Ratchet	5 mm Tapered to 7 mm	24 cm	34 cm	FR-9962-34
Mixer-style 1 x 2 DeBakey Jaws without Ratchet	5 mm Tapered to 7 mm	24 cm	34 cm	FR-9963-34

Gonzalez-Rivas Dissector

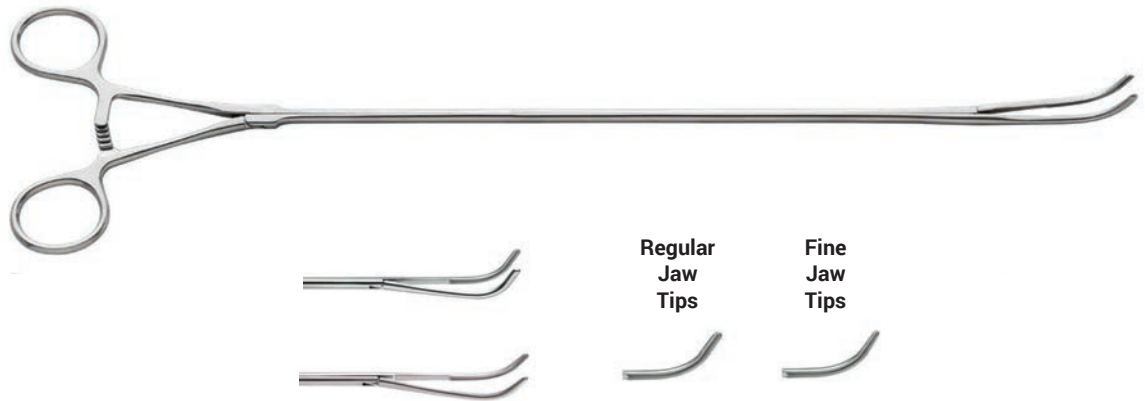

Description	Shaft Thickness	Working Length	Total Length	Code
Mixer-style 1 x 2 DeBakey Jaws with Ratchet	5 mm Tapered to 7 mm	32 cm	42 cm	FR-9964-42
Mixer-style 1 x 2 DeBakey Jaws without Ratchet	5 mm Tapered to 7 mm	32 cm	42 cm	FR-9965-42

Snake Dissector Small

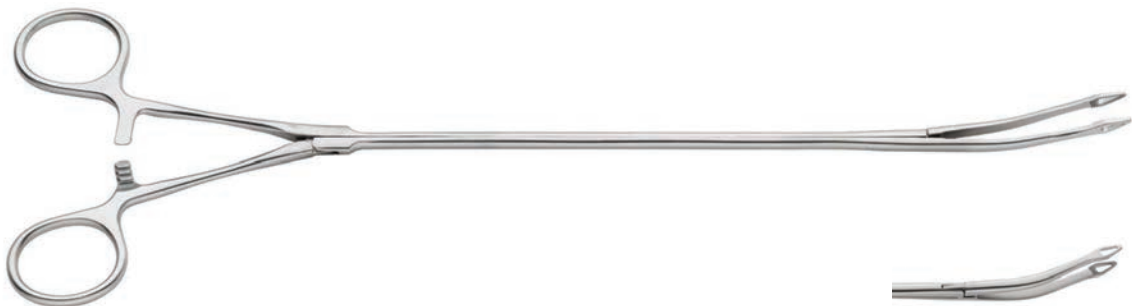

Description	Shaft Thickness	Working Length	Total Length	Code
Curved Dissector Jaws with Ratchet	5 mm Tapered to 7 mm	24 cm	34 cm	FR-9966-34
Curved Dissector Jaws without Ratchet	5 mm Tapered to 7 mm	24 cm	34 cm	FR-9967-34



Snake Dissector Large



Description	Shaft Thickness	Working Length	Total Length	Code
Curved Dissector Jaws with Ratchet	5 mm Tapered to 7 mm	24 cm	34 cm	FR-9968-34
Curved Dissector Jaws without Ratchet	5 mm Tapered to 7 mm	24 cm	34 cm	FR-9969-34

Dennis Dissector



Description	Shaft Thickness	Working Length	Total Length	Code
Curved Left Jaws Serrated Jaws with Ratchet	7 mm	23 cm	34 cm	FR-9970-34
Curved Left Jaws Serrated Jaws without Ratchet	7 mm	23 cm	34 cm	FR-9971-34

Dennis Dissector



Description	Shaft Thickness	Working Length	Total Length	Code
Curved Left Jaws Serrated Jaws with Ratchet	5 mm	32 cm	42 cm	FR-9972-42
Curved Left Jaws Serrated Jaws without Ratchet	5 mm	32 cm	42 cm	FR-9973-42

Harken Clamps

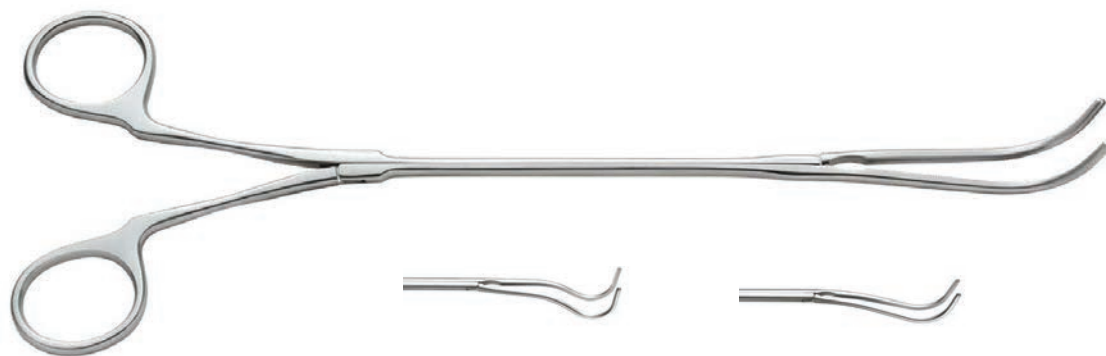

Description	Shaft Thickness	Working Length	Total Length	Code
Harken 1: 7.5 cm Tapered 1 x 2 DeBakey Jaws without Ratchet	5 mm Tapered to 7 mm	19 cm	29 cm	FR-9976-29
Harken 1: 7.5 cm Tapered 1 x 2 DeBakey Jaws with Ratchet	5 mm Tapered to 7 mm	19 cm	29 cm	FR-9977-29
Harken 2: 7.5 cm Tapered 1 x 2 DeBakey Jaws without Ratchet	5 mm Tapered to 7 mm	19 cm	29 cm	FR-9978-29
Harken 2: 7.5 cm Tapered 1 x 2 DeBakey Jaws with Ratchet	5 mm Tapered to 7 mm	19 cm	29 cm	FR-9979-29

Harken Clamps

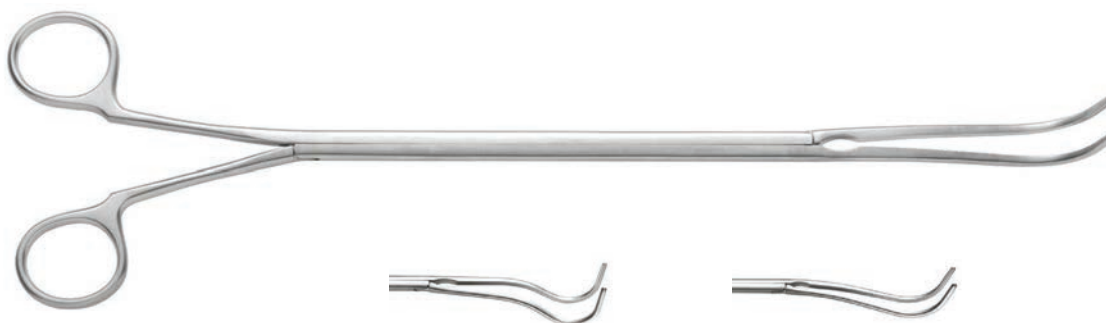

Description	Shaft Thickness	Working Length	Total Length	Code
Harken 1: 9.5 cm Tapered 1 x 2 DeBakey Jaws without Ratchet	10 mm	25 cm	36 cm	FR-9980-36
Harken 1: 9.5 cm Tapered 1 x 2 DeBakey Jaws with Ratchet	10 mm	25 cm	36 cm	FR-9981-36
Harken 2: 9.5 cm Tapered 1 x 2 DeBakey Jaws without Ratchet	10 mm	25 cm	36 cm	FR-9982-36
Harken 2: 9.5 cm Tapered 1 x 2 DeBakey Jaws with Ratchet	10 mm	25 cm	36 cm	FR-9983-36

Allis Forceps



Description	Shaft Thickness	Working Length	Total Length	Code
Curved Left 6 mm Jaws with Ratchet	7 mm	23 cm	34 cm	FR-9984-34

Allis Forceps

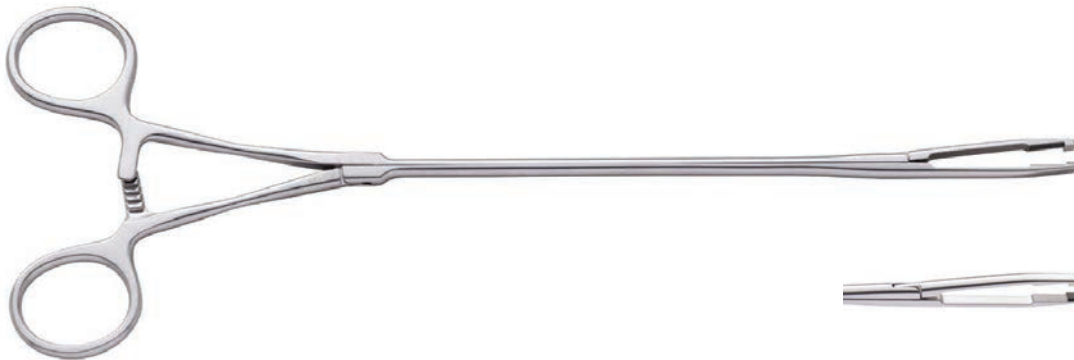

Description	Shaft Thickness	Working Length	Total Length	Code
Curved Left 4 mm Jaws with Ratchet	5 mm Tapered to 7 mm	19 cm	29 cm	FR-9985-29

Allis Forceps



Description	Shaft Thickness	Working Length	Total Length	Code
Curved Left 4 mm Jaws with Ratchet	5 mm Tapered to 7 mm	25 cm	36 cm	FR-9986-36

MICS Suction Instrument

Description	Jaw Tip Width	Shaft	Working Length	Total Length	Code
MICS Suction Instrument	5 mm	5 mm	350 mm	47 cm	FR-9933-47

Knot Pusher

Description	Jaw Tip Length	Shaft	Working Length	Total Length	Code
Knot Pusher	9 mm	5 mm	230 mm	33 cm	FR-9994-33

Cardioplegia Needle

Description	Jaw Tip Length	Shaft	Working Length	Total Length	Code
Needle		5 mm	310 mm	34 cm	FR-9995-34

Magnet Finder

Not available
in every country

Description	Jaw Tip Length	Shaft	Working Length	Total Length	Code
Magnet Finder	20 mm, Ø10 mm	5 mm	240 mm	34 cm	FR-9996-34

Endo TC Needle Holder Straight



Description

Endo TC Needle Holder, Straight,
LUER lock, irrigation port, massive Axial handle

Working Length

Ø 3,0 x 330 mm

Code

FR-10-73-500-00

Endo TC Needle Holder, Straight,
LUER lock, irrigation port, massive Axial handle

Ø 5,0 x 330 mm

FR-10-73-505-00

Endo TC Needle Holder, Straight,
LUER lock, irrigation port, massive Axial handle

Ø 5,0 x 450 mm

FR-10-73-505 XL

Endo TC Needle Holder Left Curved



Description

Endo TC Needle Holder, Left Curved,
LUER lock, irrigation port, massive Axial handle

Working Length

Ø 3,0 x 330 mm

Code

FR-10-73-500-02

Endo TC Needle Holder, Left Curved,
LUER lock, irrigation port, massive Axial handle

Ø 5,0 x 330 mm

FR-10-73-505-02

Endo TC Needle Holder, Left Curved,
LUER lock, irrigation port, massive Axial handle

Ø 5,0 x 450 mm

FR-10-73-505-02 XL



Endo Needle Holder Compact Right Curved



Description	Working Length	Code
Endo TC Needle Holder, Right Curved LUER lock, irrigation port, massive Axial handle	Ø 3,0 x 330 mm	FR-10-73-500-04
Endo TC Needle Holder, Right Curved LUER lock, irrigation port, massive Axial handle	Ø 5,0 x 330 mm	FR-10-73-505-04
Endo TC Needle Holder, Right Curved LUER lock, irrigation port, massive Axial handle	Ø 5,0 x 450 mm	FR-10-73-505-04 XL

Endo Needle Holder Compact Curved Up



Description	Working Length	Code
Endo TC Needle Holder, Curved Up LUER lock, irrigation port, massive Axial handle	Ø 5,0 x 330 mm	FR-10-73-505-06
Endo TC Needle Holder, Curved Up LUER lock, irrigation port, massive Axial handle	Ø 5,0 x 450 mm	FR-10-73-505-06 XL



Endo Needle Holder Compact Straight

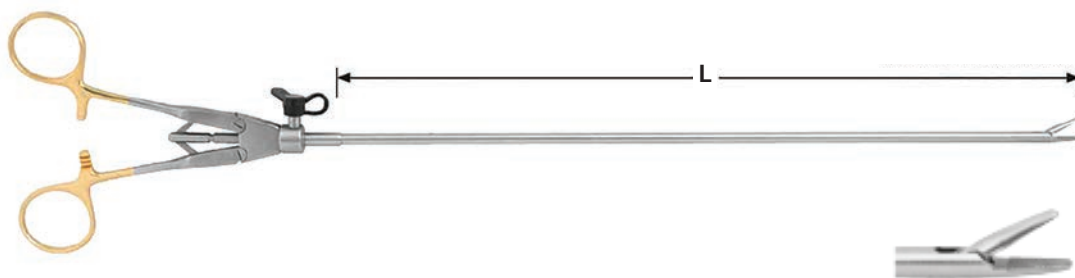

Description	Working Length	Code
Endo TC Needle Holder, Straight LUER lock, irrigation port, ring handle	Ø 5,0 x 330 mm	FR-10-73-506-00

Endo Needle Holder Compact Left Curved

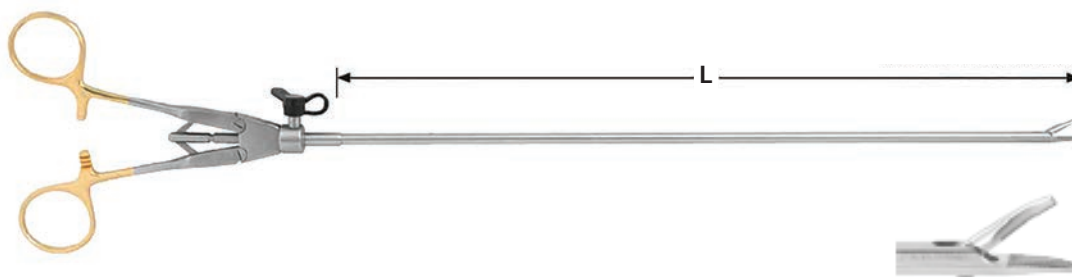

Description	Working Length	Code
Endo TC Needle Holder, Left Curved LUER lock, irrigation port, ring handle	Ø 5,0 x 330 mm	FR-10-73-506-02

Endo Needle Holder Compact Right Curved

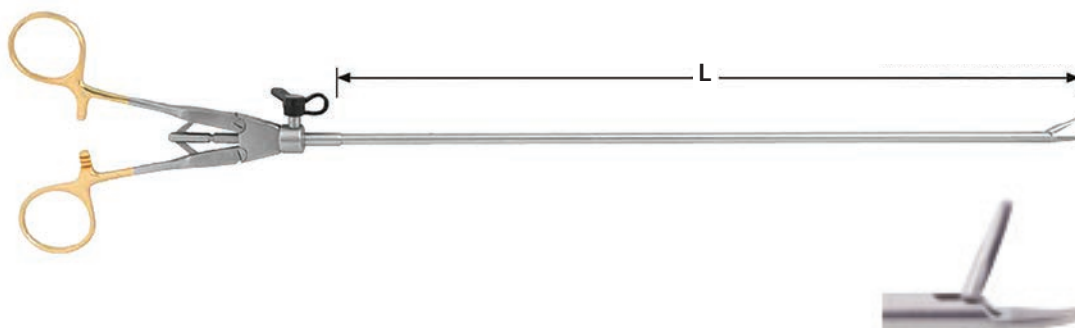

Description	Working Length	Code
Endo TC Needle Holder, Right Curved LUER lock, irrigation port, ring handle	Ø 5,0 x 330 mm	FR-10-73-506-04

SKILL Light Endo Needle Holder



Description	Working Length	Code
Endo TC Needle Holder, Straight LUER lock, irrigation port, straight aluminium handle	Ø 3.0 x 330 mm	FR-10-73-502-00
Endo TC Needle Holder, Straight LUER lock, irrigation port, straight aluminium handle	Ø 5.0 x 330 mm	FR-10-73-507-00
Endo TC Needle Holder, Straight LUER lock, irrigation port, straight aluminium handle	Ø 5.0 x 450 mm	FR-10-73-507-00 XL

SKILL Light Endo Needle Holder



Description	Working Length	Code
Endo TC Needle Holder, Left Curved LUER lock, irrigation port, straight aluminium handle	Ø 3.0 x 330 mm	FR-10-73-502-02
Endo TC Needle Holder, Left Curved LUER lock, irrigation port, straight aluminium handle	Ø 5.0 x 330 mm	FR-10-73-507-02
Endo TC Needle Holder, Left Curved LUER lock, irrigation port, straight aluminium handle	Ø 5.0 x 450 mm	FR-10-73-507-02 XL



SKILL Light Endo Needle Holder



Description	Working Length	Code
Endo TC Needle Holder, Right Curved LUER lock, irrigation port, straight aluminium handle	Ø 3.0 x 330 mm	FR-10-73-502-04
Endo TC Needle Holder, Left Curved LUER lock, irrigation port, straight aluminium handle	Ø 5.0 x 330 mm	FR-10-73-507-04
Endo TC Needle Holder, Left Curved LUER lock, irrigation port, straight aluminium handle	Ø 5.0 x 450 mm	FR-10-73-507-04 XL

SKILL Light Endo Needle Holder



Description	Working Length	Code
Endo TC Needle Holder, Curved Up LUER lock, irrigation port, straight aluminium handle self adjusting	Ø 5.0 x 330 mm	FR-10-73-507-08
LUER lock, irrigation port, straight aluminium handle self adjusting	Ø 5.0 x 450 mm	FR-10-73-507-08 XL



SKILL Light Endo Needle Holder

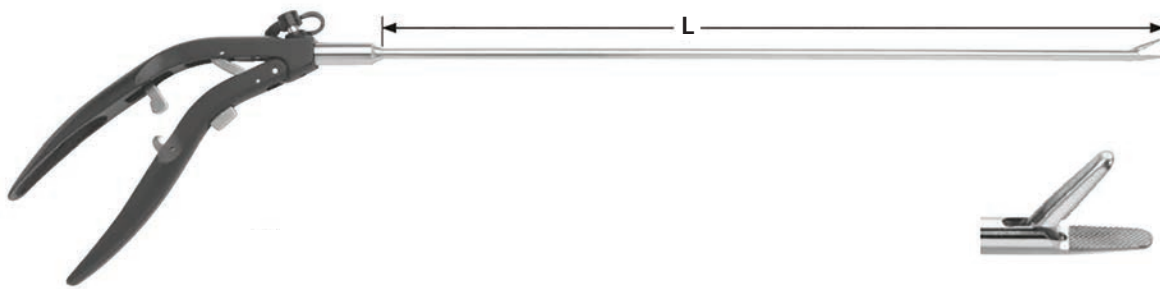

Description	Working Length	Code
Endo TC Needle Holder, Straight LUER lock, irrigation port, angled aluminium handle self adjusting	Ø 3.0 x 330 mm	FR-10-73-503-00
LUER lock, irrigation port, angled aluminium handle self adjusting	Ø 5.0 x 330 mm	FR-10-73-509-00
LUER lock, irrigation port, angled aluminium handle self adjusting	Ø 5.0 x 450 mm	FR-10-73-509-00 XL

SKILL Light Endo Needle Holder

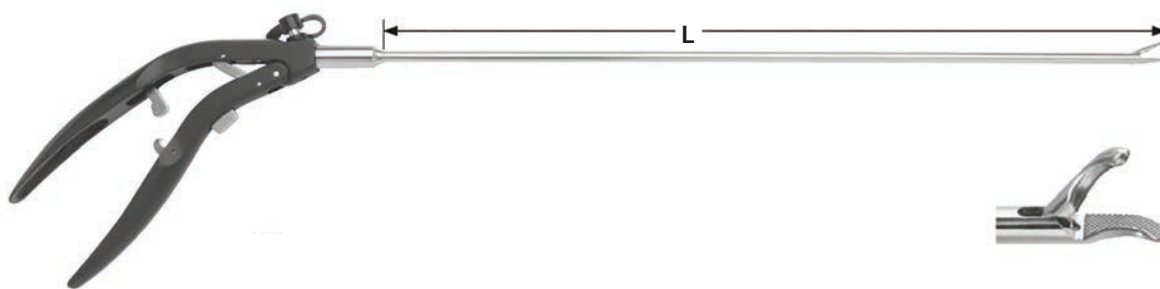

Description	Working Length	Code
Endo TC Needle Holder, Left Curved LUER lock, irrigation port, angled aluminium handle self adjusting	Ø 3.0 x 330 mm	FR-10-73-503-02
Endo TC Needle Holder, Left Curved LUER lock, irrigation port, angled aluminium handle self adjusting	Ø 5.0 x 330 mm	FR-10-73-509-02
Endo TC Needle Holder, Left Curved LUER lock, irrigation port, angled aluminium handle self adjusting	Ø 5.0 x 450 mm	FR-10-73-509-02 XL



SKILL Light Endo Needle Holder

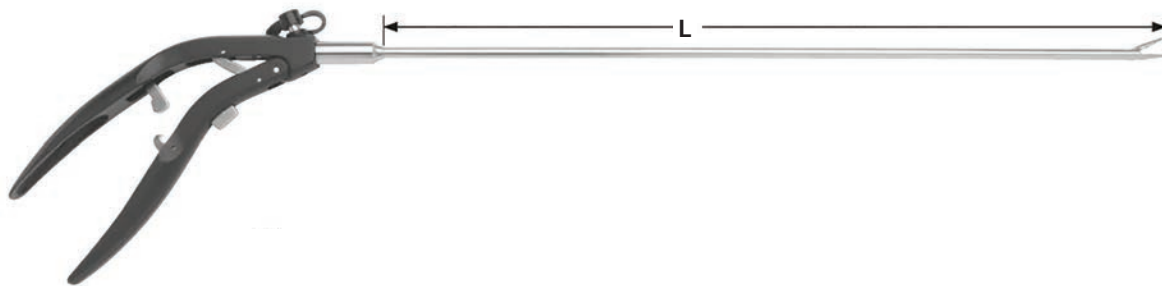

Description	Working Length	Code
Endo TC Needle Holder, Right Curved LUER lock, irrigation port, angled aluminium handle self adjusting	Ø 3.0 x 330 mm	FR-10-73-503-04
Endo TC Needle Holder, Right Curved LUER lock, irrigation port, angled aluminium handle self adjusting	Ø 5.0 x 330 mm	FR-10-73-509-04
Endo TC Needle Holder, Right Curved LUER lock, irrigation port, angled aluminium handle self adjusting	Ø 5.0 x 450 mm	FR-10-73-50--04 XL

SKILL Light Endo Needle Holder

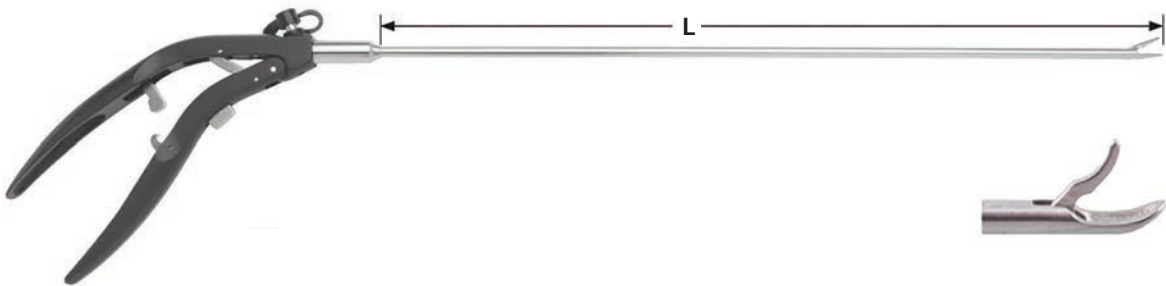

Description	Working Length	Code
Endo TC Needle Holder, Curved Up LUER lock, irrigation port, straight aluminium handle self adjusting	Ø 5.0 x 330 mm	FR-10-73-509-08
Endo TC Needle Holder, Curved Up LUER lock, irrigation port, straight aluminium handle self adjusting	Ø 5.0 x 450 mm	FR-10-73-509-08 XL



Endo Needle Holder

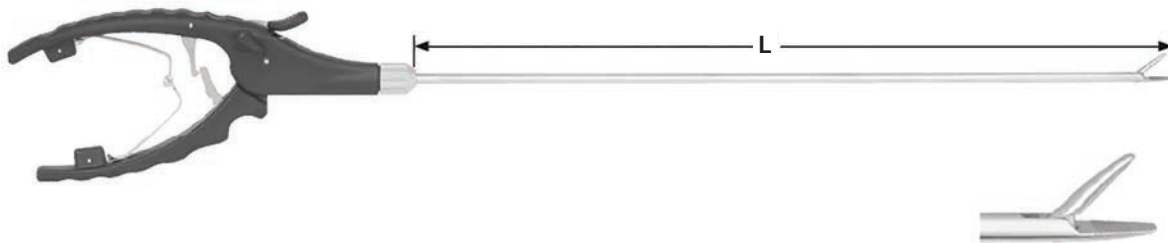

Description

Endo TC Needle Holder, Straight, Axial plastic handle

Working Length

Ø 5.0 x 330 mm

Code

FR-10-73-510-00

Endo Needle Holder

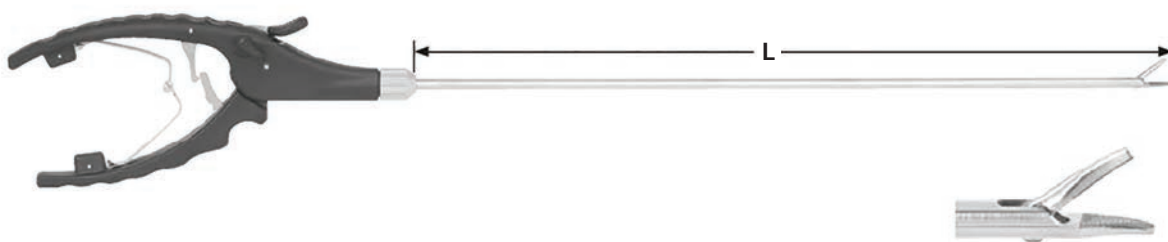

Description

Endo TC Needle Holder, Left Curved, Axial plastic handle

Working Length

Ø 5.0 x 330 mm

Code

FR-10-73-510-02

Endo Needle Holder



Description

Endo TC Needle Holder, Right Curved, Axial plastic handle

Working Length

Ø 5.0 x 330 mm

Code

FR-10-73-510-04

Endo Needle Holder



Description

Endo TC Needle Holder, Right Curved, Axial plastic handle

Working Length

Ø 5.0 x 330 mm

Code

FR-10-73-510-04

Clip applying Forceps Ø 10.0 mm for Bulldog Clamps

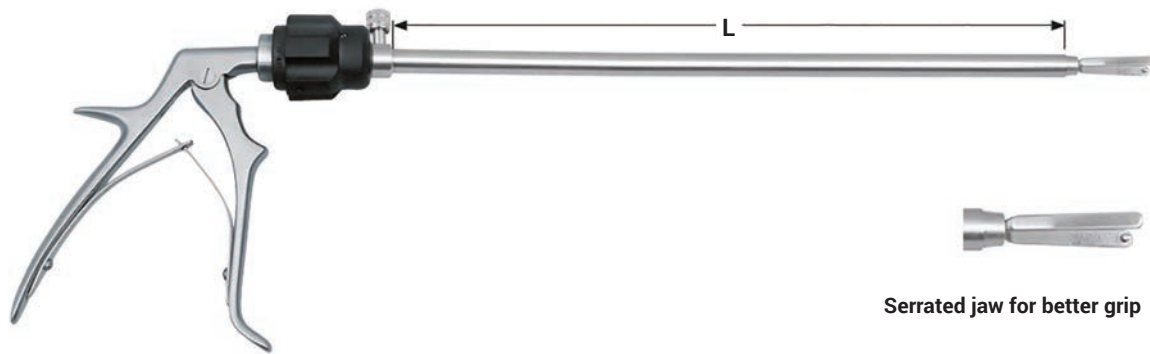

360° Rotatable, LUER LOCK connection

Description

Bulldog Clamps Ø 10 mm

Working Length

330 mm

Code

FR-10-73-580-33



Bulldog Clamps DeBakey



2 x 3 Row of Teeth

Description	Jaw Length	Code
Bulldog Clamps Straight	17 mm	FR-10-73-586-17
Bulldog Clamps Straight	25 mm	FR-10-73-586-25
Bulldog Clamps Straight	45 mm	FR-10-73-586-45
Bulldog Clamps Straight	60 mm	FR-10-73-586-60

Bulldog Clamps DeBakey



2 x 3 Row of Teeth

Description	Jaw Length	Code
Bulldog Clamps Curved	17 mm	FR-10-73-587-17
Bulldog Clamps Curved	25 mm	FR-10-73-587-25
Bulldog Clamps Curved	45 mm	FR-10-73-587-45
Bulldog Clamps Curved	60 mm	FR-10-73-587-60

Bulldog Clamps DeBakey-Satinsky



2 x 3 Row of Teeth

Description	Jaw Length	Code
Bulldog Clamps Curved	17 mm	FR-10-73-587-17
Bulldog Clamps Curved	25 mm	FR-10-73-587-25
Bulldog Clamps Curved	45 mm	FR-10-73-587-45
Bulldog Clamps Curved	60 mm	FR-10-73-587-60

Fan Retractors



Description

Fan Retractors, 5 Fingers, irrigation channel

Jaw Length

Ø 5,0 x 340 mm

Code

FR-10-73-707-34

Fan Retractors

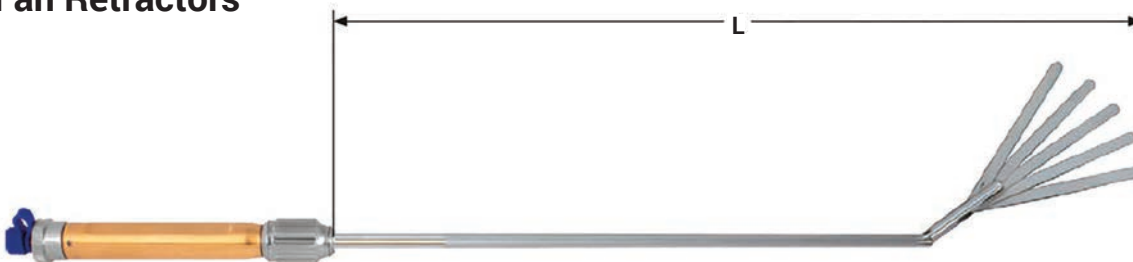

Description

Fan Retractors, 5 Fingers, 50° angle, irrigation channel

Jaw Length

Ø 5,0 x 340 mm

Code

FR-10-73-707-34

Fan Retractors



Description

Fan Retractors, 5 Fingers, irrigation channel

Jaw Length

Ø 10,0 x 340 mm

Code

FR-10-73-709-34

Fan Retractors



Description

Fan Retractors, 5 Fingers, 50° angle, irrigation channel

Jaw Length

Ø 10,0 x 340 mm

Code

FR-10-73-710-34

Fan Retractors

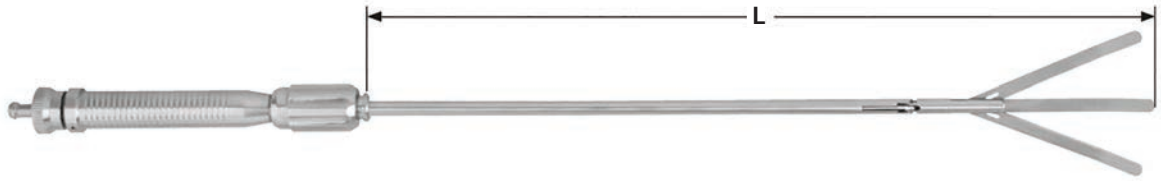

Description	Jaw Length	Code
Fan Retractors, 3 Fingers, 60° angle, irrigation channel, detachable	Ø 50,0 x 330 mm	FR-10-73-703-33
Fan Retractors, 3 Fingers, 60° angle, irrigation channel, detachable	Ø 50,0 x 450 mm	FR-10-73-703-45

Fan Retractors

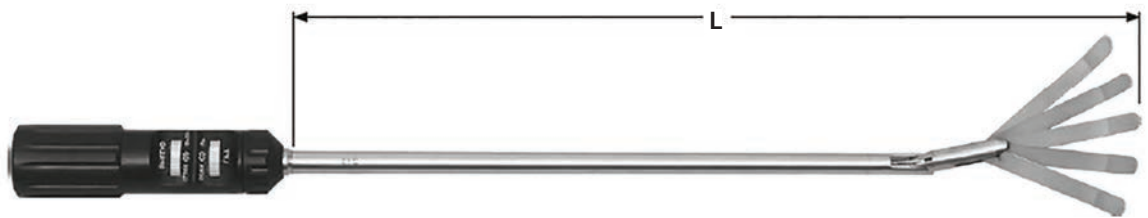

Description	Jaw Length	Code
Fan Retractors, 5 Fingers, 80° angle, irrigation channel, detachable	Ø 10,0 x 330 mm	FR-10-73-705-33
Fan Retractors, 5 Fingers, 80° angle, irrigation channel, detachable	Ø 10,0 x 450 mm	FR-10-73-705-45

Endo Retractors, angle with Luer-Lock irrigation channel

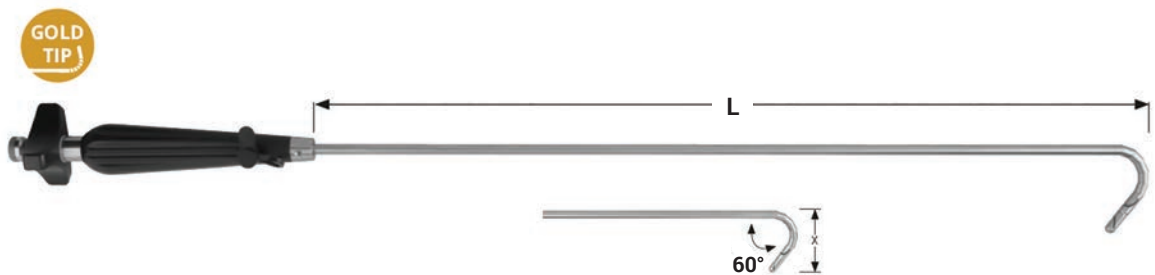

Description	Jaw Length	Code
Finger Retractor, 60° angle, X = 40 mm L = 380 mm	Ø 5,0	FR-10-73-712-40

Endo Retractors, angle with Luer-Lock irrigation channel

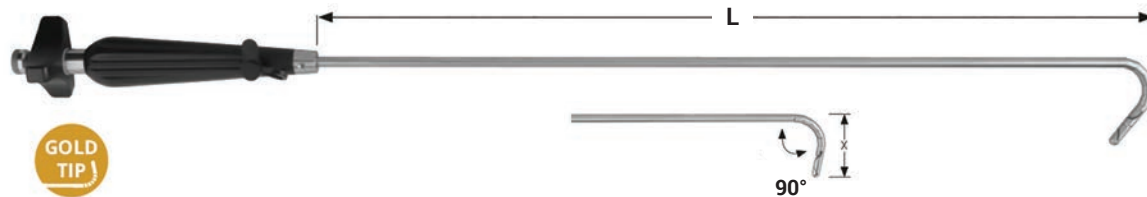

Description

Finger Retractor, 90° angle, X = 40 mm L = 430 mm

Jaw Length

Ø 5,0

Code

FR-10-73-712-40 XL

Endo Retractors, angle with Luer-Lock irrigation channel



Description

Triangular Retractor, X = 60 mm L = 380 mm

Triangular Retractor, X = 60 mm L = 450 mm

Jaw Length

Ø 5,0

Ø 5,0

Code

FR-10-73-712-60

FR-10-73-712-60 XL

Endo Retractors, angle with Luer-Lock irrigation channel



Description

Triangular Retractor, X = 80 mm L = 380 mm

Triangular Retractor, X = 80 mm L = 450 mm

Jaw Length

Ø 5,0

Ø 5,0

Code

FR-10-73-712-80

FR-10-73-712-80 XL

Endo Retractors, angle with Luer-Lock irrigation channel



Description	Jaw Length	Code
Triangular Retractor, X = 120 mm L = 380 mm	Ø 5,0	FR-10-73-712-12
Triangular Retractor, X = 120 mm L = 450 mm	Ø 5,0	FR-10-73-712-12 XL

Endo Retractors, angle with Luer-Lock irrigation channel



Description	Jaw Length	Code
Triangular Retractor, angled X = 60 mm L = 380 mm	Ø 5,0	FR-10-73-713-60
Triangular Retractor, angled X = 60 mm L = 450 mm	Ø 5,0	FR-10-73-713-60 XL

Endo Retractors, angle with Luer-Lock irrigation channel

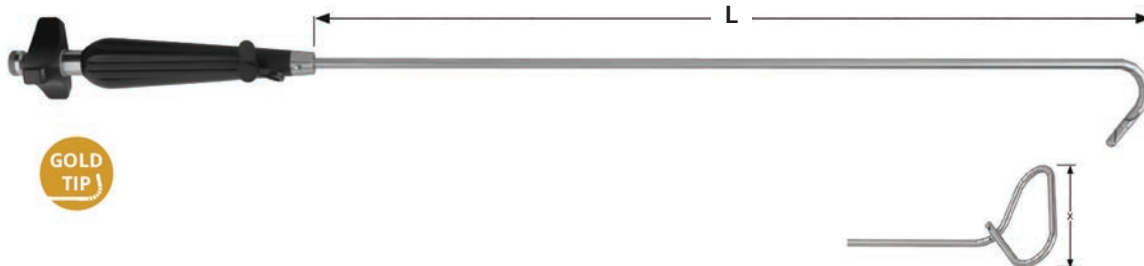

Description	Jaw Length	Code
Triangular Retractor, angled X = 80 mm L = 380 mm	Ø 5,0	FR-10-73-713-80
Triangular Retractor, angled X = 80 mm L = 450 mm	Ø 5,0	FR-10-73-713-80 XL

Endo Retractors, angle with Luer-Lock irrigation channel

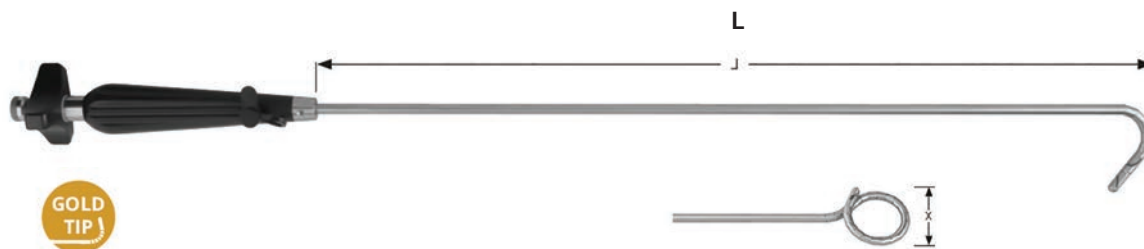

GOLD TIP

Description	Jaw Length	Code
Triangular Retractor, circular X = 40 mm L = 380 mm	Ø 5,0	FR-10-73-714-40
Triangular Retractor, circular X = 40 mm L = 450 mm	Ø 5,0	FR-10-73-714-40 XL

Endo Retractors, angle with Luer-Lock irrigation channel

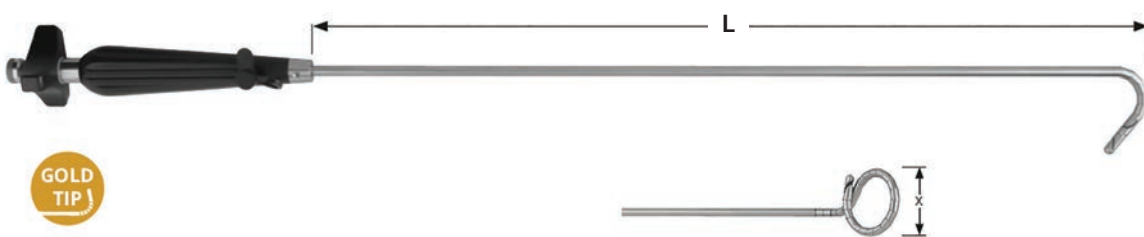

GOLD TIP

Description	Jaw Length	Code
Triangular Retractor, circular angled X = 40 mm L = 380 mm	Ø 5,0	FR-10-73-715-40
Triangular Retractor, circular angled X = 40 mm L = 450 mm	Ø 5,0	FR-10-73-715-40 XL

Endo Retractors, angle with Luer-Lock irrigation channel



GOLD TIP

Description	Jaw Length	Code
Endo Retractor, hooked shape left, 45° angled downwards, L = 380 mm	Ø 5,0	FR-10-73-716-45
Endo Retractor, hooked shape left, 45° angled downwards, L = 450 mm	Ø 5,0	FR-10-73-716-45 XL

Endo Retractors, angle with Luer-Lock irrigation channel



Description	Jaw Length	Code
Endo Retractor, hooked shape right, 45° angled downwards, L = 380 mm	Ø 5,0	FR-10-73-717-45
Endo Retractor, hooked shape right, 45° angled downwards, L = 450 mm	Ø 5,0	FR-10-73-717-45 XL

Endo Retractors, angle with Luer-Lock irrigation channel

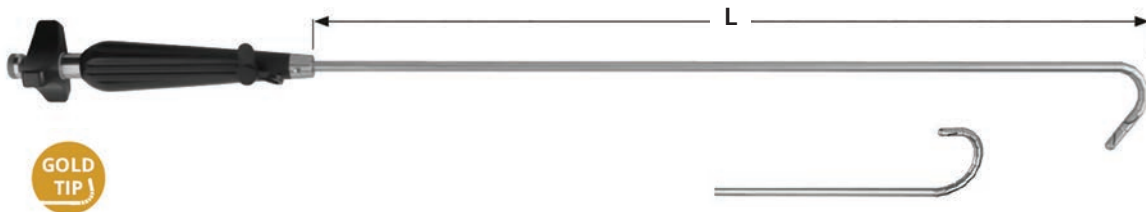

Description	Jaw Length	Code
Endo Retractor, hooked shape right, 45° angled downwards, L = 380 mm	Ø 5,0	FR-10-73-717-45
Endo Retractor, hooked shape right, 45° angled downwards, L = 450 mm	Ø 5,0	FR-10-73-717-45 XL

Endo Retractors, angle with Luer-Lock irrigation channel



Description	Jaw Length	Code
Endo Retractor, hooked shape left, 90° angled downwards, L = 380 mm	Ø 5,0	FR-10-73-716-90
Endo Retractor, hooked shape left, 90° angled downwards, L = 450 mm	Ø 5,0	FR-10-73-716-90 XL

Endo Retractors, angle with Luer-Lock irrigation channel

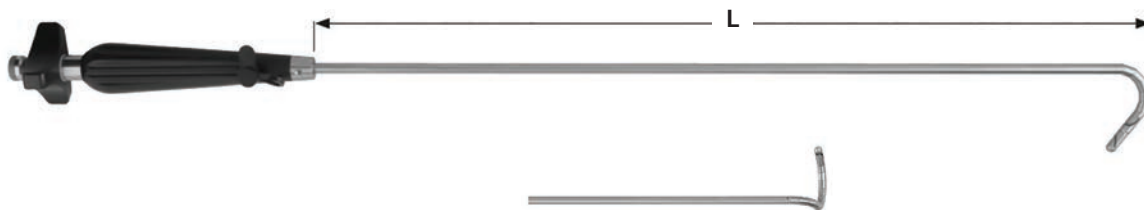

Description	Jaw Length	Code
Endo Retractor, hooked shape right, 90° angled downwards, L = 380 mm	Ø 5,0	FR-10-73-7167-90
Endo Retractor, hooked shape right, 90° angled downwards, L = 450 mm	Ø 5,0	FR-10-73-717-90 XL

SKILL Thoracic Suction Tube

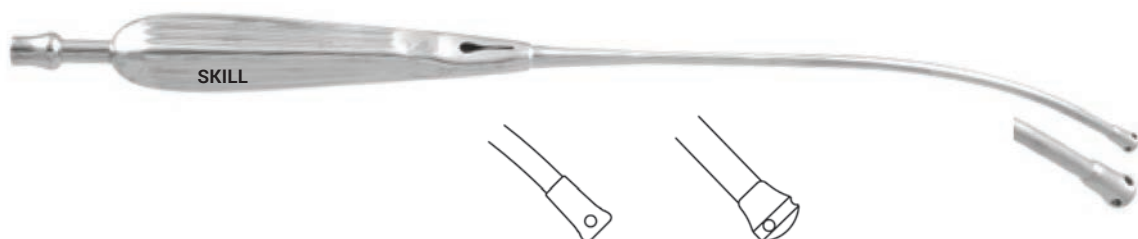

Description	Total Length	Code
Finger tip controlled suction regulator 3.5 mm shaft / 5.8 mm tip	35 cm	FR-10-180-35
Finger tip controlled suction regulator 3.5 mm shaft / 5.8 mm tip	40 cm	FR-10-181-40

SKILL Thoracic Suction Tube

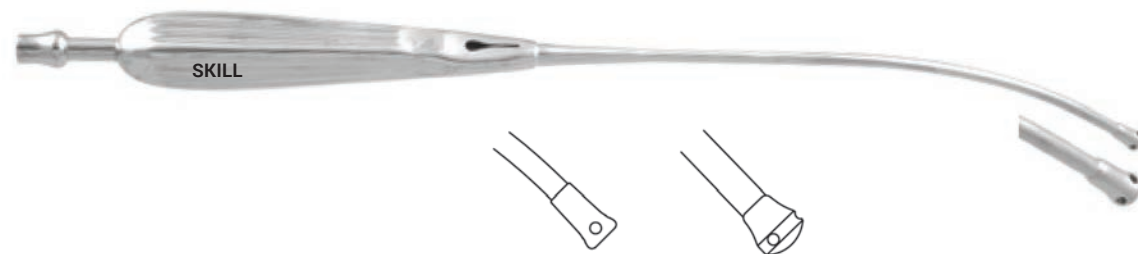

Description	Total Length	Code
Finger tip controlled suction regulator 4.9 mm shaft / 8 mm tip	40 cm	FR-10-182-40
Finger tip controlled suction regulator 3.5 mm shaft / 7.9 mm tip	45 cm	FR-10-183-45

SKILL Thoracic Suction Tube



Description	Total Length	Code
With Yankauer handle / 5 mm tube / 17 1/4" Straight	44 cm	FR-10-184-44

SKILL Thoracic Suction Tube



Description	Total Length	Code
With Yankauer handle / 5 mm tube / 17 1/4" Angled	44 cm	FR-10-185-44

SKILL Thoracic Suction Tube



Description	Total Length	Code
With Yankauer handle / 5 mm tube / 17 1/4" Straight with basket tip	44 cm	FR-10-186-44

SKILL Thoracic Suction Tube



Description	Total Length	Code
With Yankauer handle / 5 mm tube / 17 1/4" Angled with basket tip	44 cm	FR-10-187-44

SKILL Thoracic Suction Tube



Description	Total Length	Code
With Yankauer handle / 10 mm tube / 18 3/4" Straight	48 cm	FR-10-188-48

SKILL Thoracic Suction Tube



Description	Total Length	Code
With Yankauer handle / 10 mm tube / 18 1/2" Angled	47 cm	FR-10-189-47



Adam Yozu Retractor

**Description**

Adam Yozu Retractor 55 mm x 50 mm x 100 mm x 95 mm

Exchangeable Blades 65 mm x 50 mm Set

Code

CB1-10-719-03

Adam Yozu Retractor

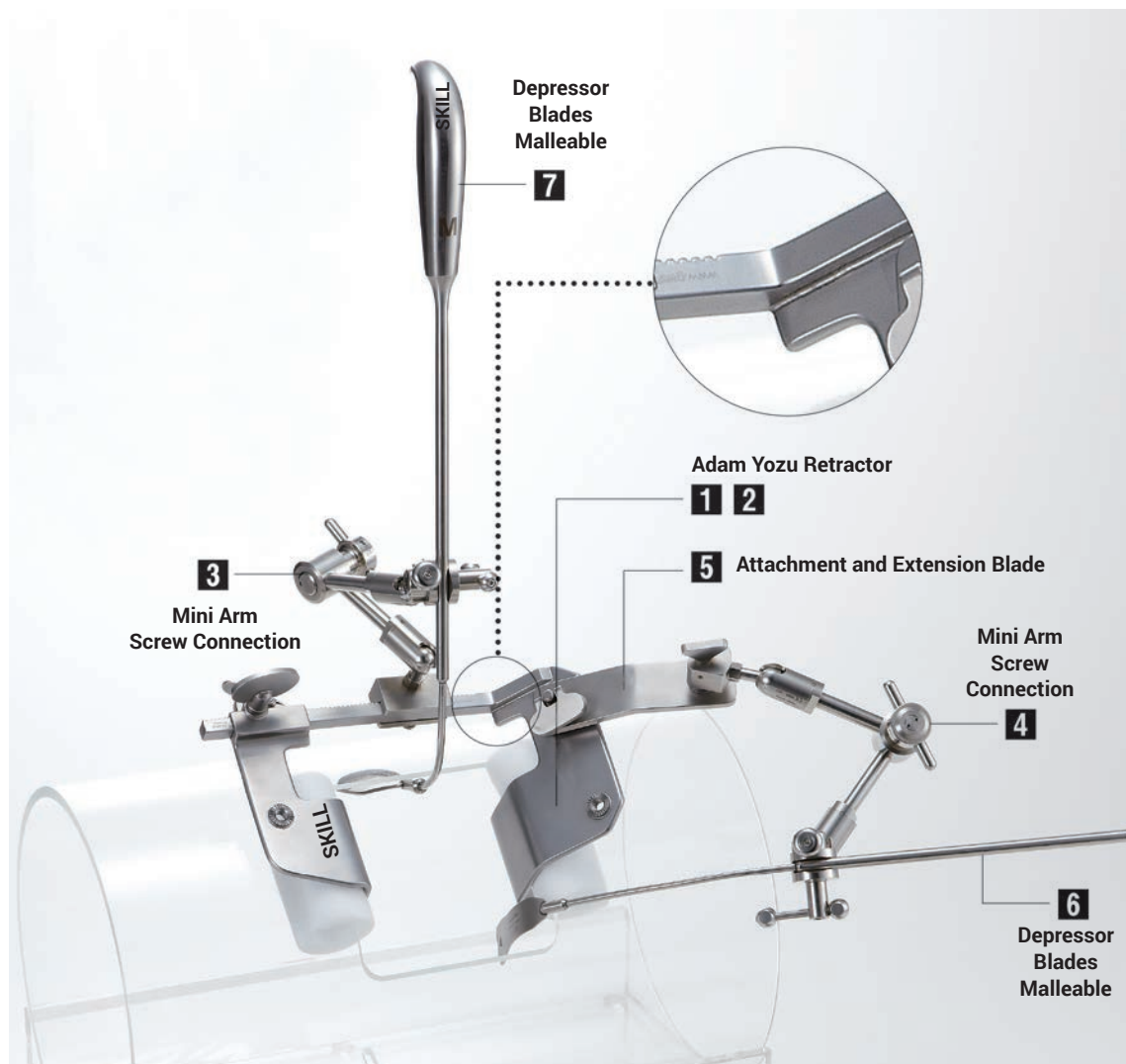

Exchangeable Blades



Mini Arm Screw Connection

Description	Code
Adam Yozu Retractor 45 mm x 40 mm x 100 mm x 95 mm	
Exchangeable Blades 55 mm x 40 mm Set	CB1-10-719-02

Description	Code
Mini Arm with Screw Connection	CB1-10-719-10

Adam Yozu Retractor

Description

Mini Arm with Screw Connector

Code

CB1-10-719-11

Mini Arm with Quick Connector for Spreading Bar

CB1-10-719-12

Attachment and Extension Blade

CB1-10-719-13

Description

Total Length

Code

Depressor Blade Malleable XXS, Paediatric	46 cm	85 mm	18 mm	CB1-10-719-14
Depressor Blade Malleable XS	44 cm	70 mm	23 mm	CB1-10-719-15
Depressor Blade Malleable S	44 cm	70 mm	28 mm	CB1-10-719-16
Depressor Blade Malleable M	44 cm	70 mm	35 mm	CB1-10-719-17
Depressor Blade Malleable L	44 cm	70 mm	45 mm	CB1-10-719-18
Depressor Blade Malleable XL	47 cm	90 mm	45 mm	CB1-10-719-19

Description

Total Length

Code

Spatula Malleable	36 cm	70 mm	20 mm	CB1-10-719--20
-------------------	-------	-------	-------	----------------



	A	B	C	D
Retractor	55 mm	50 mm	100 mm	95 mm
	65 mm	50 mm		
Small Version	45 mm	40 mm	100 mm	95 mm
	55 mm	40 mm		



Mini-Thoracotomy Retractor Straight

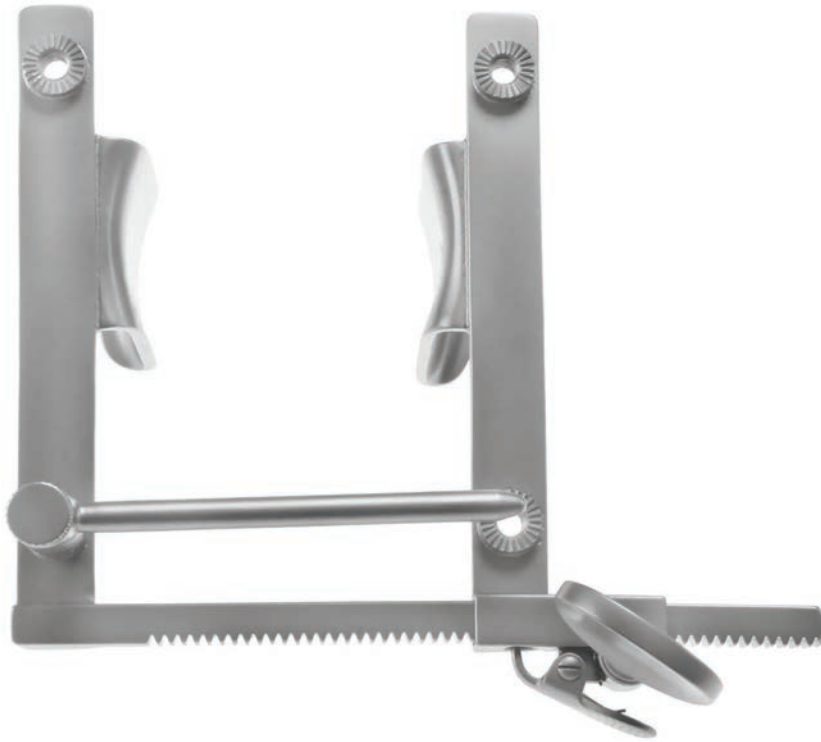

Description

Mini Thoracotomy w Straight
Arms 40 mm x 60 mm Blades Turnable Crossbar

Code

CB1-10-9850-00

Mini-Thoracotomy Retractor Curved Arms

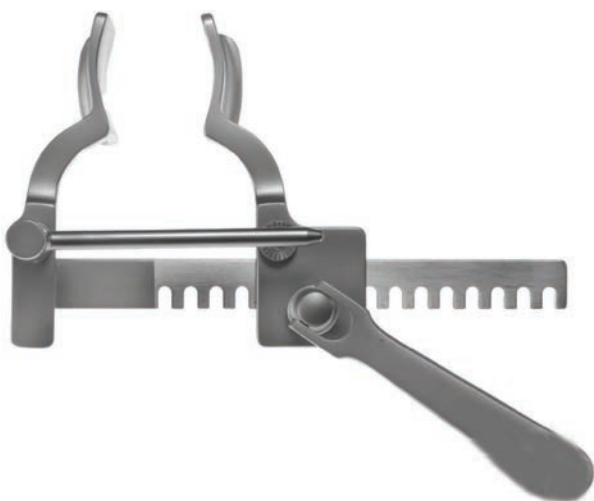

Description

Mini Thoracotomy Retractor Curved Arms 36 mm x 60 mm Blades Strong
Spreading Bar attachments

Code

CB1-10-9851-00

Mini-Thoracotomy Retractor Curved Arms



Description	Code
Mini Thoracotomy Retractor Hinged Arms 2 x 2 Exchangeable Blades 36 mm x 38 mm, 36 mm x 52 mm	
Turnable Crossbar for attachments	CB1-10-9852-00

Fixation Clamps

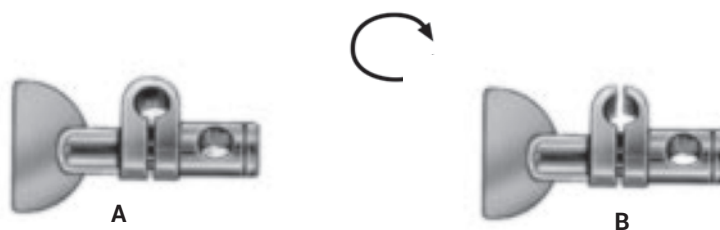

Description	Fig	Ø mm	Length mm	Code
Fixation Clamps	A	6		CB1-10-9853-01
Fixation Clamps	B	6	Splitted	CB1-10-9853-02

SKILL[®]

Surgical Instruments

SPECIALITY INSTRUMENTS





Index

Speciality Instruments

DeBakey Bulldog Clamp	456
Titanium DeBakey Bulldog Clamp	456-457
Glover Bulldog Clamp	457
Diethrich Bulldog Clamp	458-459
Titanium Vena Cava Bulldog Clamp	460-461
Frasier Suction Tube	461
Yankauer Suction Tube	462
Poole Suction Tube	463-464
Cardiac Suction Tube Andrew Pynchon Suction Tube	465-466
Pediatric Cardiac Suction Tube	466-467
Finsterer Suction Tube	467
Yankauer Suction Tube	468
Tunneling Set	469
Tibbs Arterial Cannula Ross Sump Sucker	470
Cooley Vascular Dilator	471
DeBakey Vascular Dilator	473
Garrett Vascular Dilator	473
Bakes Dilator Set	474
DeBakey Vascular Dilators Titanium Handle Leksell Bone Rongeur	475
Cushing Nerve Hook	476
Hegar Dilator Set Tubbs Aortic Dilator	477
Cardiac Tube Holders	478
Ligature Catcher	479



DeBakey Bulldog Clamp Straight



Description	Length	Code
DeBakey Bulldog Clamp Straight	8 cm	BF-507-08
DeBakey Bulldog Clamp Straight	9 cm	BF-507-09
DeBakey Bulldog Clamp Straight	10 cm	BF-507-10
DeBakey Bulldog Clamp Straight	12 cm	BF-507-12

DeBakey Bulldog Clamp Curved



Description	Length	Code
DeBakey Bulldog Clamp Curved	8 cm	BF-508-08
DeBakey Bulldog Clamp Curved	9 cm	BF-508-09
DeBakey Bulldog Clamp Curved	10 cm	BF-508-10
DeBakey Bulldog Clamp Curved	12 cm	BF-508-12

Titanium DeBakey Bulldog Clamp Straight



Description	Length	Code
Titanium DeBakey Bulldog Clamp Straight	7 cm	BF-507-07T
Titanium DeBakey Bulldog Clamp Straight	8 cm	BF-507-08T
Titanium DeBakey Bulldog Clamp Straight	9 cm	BF-507-09T
Titanium DeBakey Bulldog Clamp Straight	10 cm	BF-507-10T
Titanium DeBakey Bulldog Clamp Straight	11 cm	BF-507-11T
Titanium DeBakey Bulldog Clamp Straight	12 cm	BF-507-12T
Titanium DeBakey Bulldog Clamp Straight	13 cm	BF-507-13T

Titanium DeBakey Bulldog Clamp Curved



Description	Length	Code
Titanium DeBakey Bulldog Clamp Curved	7 cm	BF-508-07T
Titanium DeBakey Bulldog Clamp Curved	8 cm	BF-508-08T
Titanium DeBakey Bulldog Clamp Curved	9 cm	BF-508-09T
Titanium DeBakey Bulldog Clamp Curved	10 cm	BF-508-10T
Titanium DeBakey Bulldog Clamp Curved	11 cm	BF-508-11T
Titanium DeBakey Bulldog Clamp Curved	12 cm	BF-508-12T
Titanium DeBakey Bulldog Clamp Curved	13 cm	BF-508-13T

Glover Bulldog Clamp Straight



Description	Length	Code
Glover Bulldog Clamp Straight	6 cm	BF-509-06
Glover Bulldog Clamp Straight	7 cm	BF-509-07
Glover Bulldog Clamp Straight	10 cm	BF-509-10
Glover Bulldog Clamp Straight	12 cm	BF-509-12

Glover Bulldog Clamp Curved



Description	Length	Code
Glover Bulldog Clamp Curved	6 cm	BF-510-06
Glover Bulldog Clamp Curved	7 cm	BF-510-07
Glover Bulldog Clamp Curved	10 cm	BF-510-10
Glover Bulldog Clamp Curved	12 cm	BF-510-12

Diethrich Bulldog Clamp



Description	Length	Code
Diethrich Bulldog Clamp Straight	8 cm	BF-511-08
Diethrich Bulldog Clamp Straight	12 cm	BF-511-12
Diethrich Bulldog Clamp Straight	20 cm	BF-511-20
Diethrich Bulldog Clamp Angled	8 cm	BF-512-08
Diethrich Bulldog Clamp Angled	12 cm	BF-512-12
Diethrich Bulldog Clamp Angled	20 cm	BF-512-20

Titanium Diethrich Bulldog Clamp



Description	Length	Code
Titanium Diethrich Bulldog Clamp Straight	8 cm	BF-511-08T
Titanium Diethrich Bulldog Clamp Straight	12 cm	BF-511-12T
Titanium Diethrich Bulldog Clamp Straight	20 cm	BF-511-20T
Titanium Diethrich Bulldog Clamp Angled	8 cm	BF-512-08T
Titanium Diethrich Bulldog Clamp Angled	12 cm	BF-512-12T
Titanium Diethrich Bulldog Clamp Angled	20 cm	BF-512-20T



DeBakey Diethrich Bulldog Clamp



Description	Length	Code
DeBakey Diethrich Bulldog Clamp Straight	10 cm	BF-512-10
DeBakey Diethrich Bulldog Clamp Straight	14 cm	BF-512-14
DeBakey Diethrich Bulldog Clamp Straight	20 cm	BF-512-20
DeBakey Diethrich Bulldog Clamp Angled	10 cm	BF-513-10
DeBakey Diethrich Bulldog Clamp Angled	14 cm	BF-513-14
DeBakey Diethrich Bulldog Clamp Angled	20 cm	BF-513-20
DeBakey Diethrich Bulldog Clamp Curved	10 cm	BF-514-10
DeBakey Diethrich Bulldog Clamp Curved	14 cm	BF-514-14
DeBakey Diethrich Bulldog Clamp Curved	20 cm	BF-514-20

Titanium DeBakey Diethrich Bulldog Clamp



Description	Length	Code
Titanium DeBakey Diethrich Bulldog Clamp Straight	10 cm	BF-512-10T
Titanium DeBakey Diethrich Bulldog Clamp Straight	14 cm	BF-512-14T
Titanium DeBakey Diethrich Bulldog Clamp Straight	20 cm	BF-512-20T
Titanium DeBakey Diethrich Bulldog Clamp Angled	10 cm	BF-513-10T
Titanium DeBakey Diethrich Bulldog Clamp Angled	14 cm	BF-513-14T
Titanium DeBakey Diethrich Bulldog Clamp Angled	20 cm	BF-513-20T
Titanium DeBakey Diethrich Bulldog Clamp Curved	10 cm	BF-514-10T
Titanium DeBakey Diethrich Bulldog Clamp Curved	14 cm	BF-514-14T
Titanium DeBakey Diethrich Bulldog Clamp Curved	20 cm	BF-514-20T

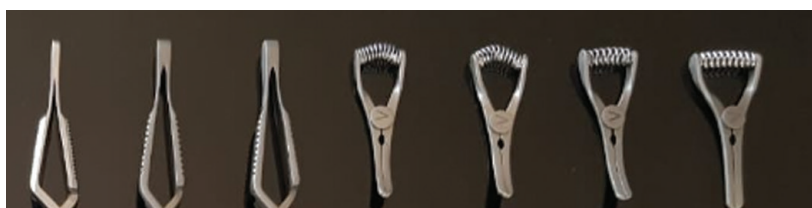

Titanium Vena Cava Bulldog Clamp Straight

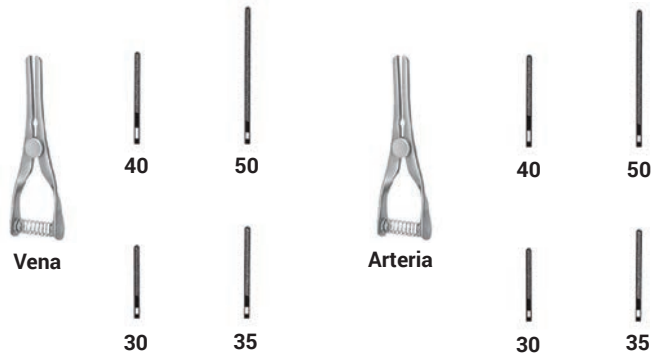

Description

- Vena Bulldog Clamp Straight 30 mm
- Vena Bulldog Clamp Straight 35 mm
- Vena Bulldog Clamp Straight 40 mm
- Vena Bulldog Clamp Straight 50 mm
- Arteria Bulldog Clamp Straight 30 mm
- Arteria Bulldog Clamp Straight 35 mm
- Arteria Bulldog Clamp Straight 40 mm
- Arteria Bulldog Clamp Straight 50 mm

Code

- BF-513-30
- BF-513-35
- BF-513-40
- BF-513-50
- BF-514-30
- BF-514-35
- BF-514-40
- BF-514-50

Titanium Vena Cava Bulldog Clamp Curved

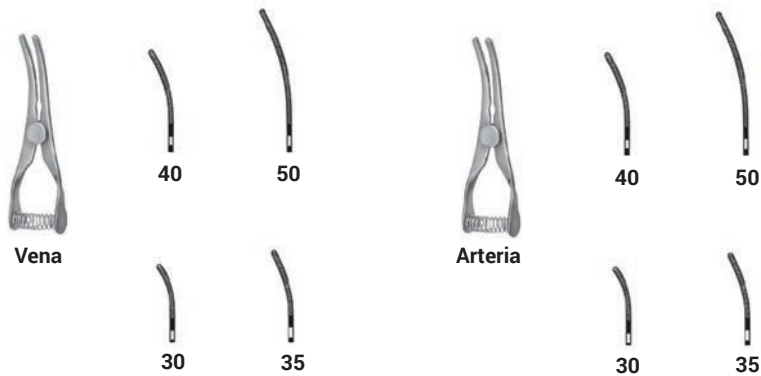

Description

- Vena Bulldog Clamp Curved 30 mm
- Vena Bulldog Clamp Curved 35 mm
- Vena Bulldog Clamp Curved 40 mm
- Vena Bulldog Clamp Curved 50 mm
- Arteria Bulldog Clamp Curved 30 mm
- Arteria Bulldog Clamp Curved 35 mm
- Arteria Bulldog Clamp Curved 40 mm
- Arteria Bulldog Clamp Curved 50 mm

Code

- BF-515-30
- BF-515-35
- BF-515-40
- BF-515-50
- BF-516-30
- BF-516-35
- BF-516-40
- BF-516-50

Titanium Vena Cava Bulldog Clamp Fully Curved

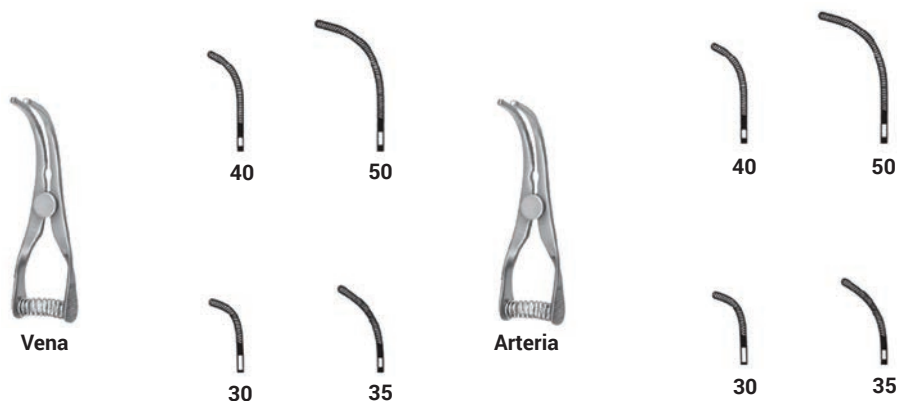

Description

- Vena Bulldog Clamp Fully Curved 30 mm
- Vena Bulldog Clamp Fully Curved 35 mm
- Vena Bulldog Clamp Fully Curved 40 mm
- Vena Bulldog Clamp Fully Curved 50 mm
- Arteria Bulldog Clamp Fully Curved 30 mm
- Arteria Bulldog Clamp Fully Curved 35 mm
- Arteria Bulldog Clamp Fully Curved 40 mm
- Arteria Bulldog Clamp Fully Curved 50 mm

Code

- BF-517-30
- BF-517-35
- BF-517-40
- BF-517-50
- BF-518-30
- BF-518-35
- BF-518-40
- BF-518-50

Frasier Suction Tube

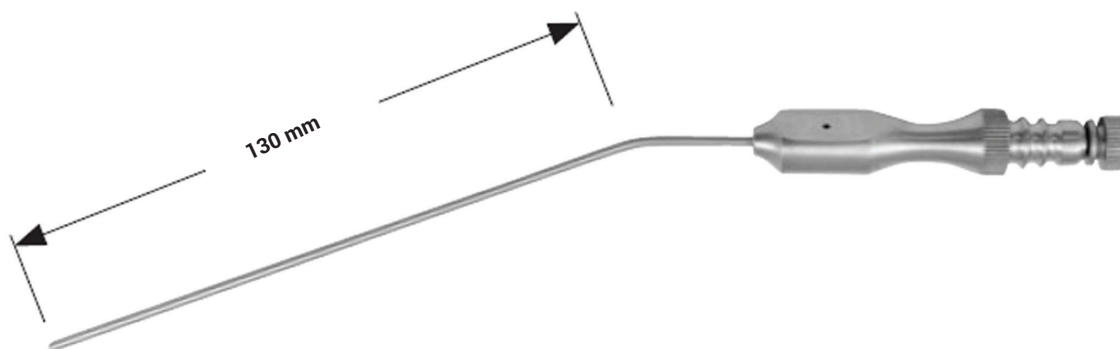

Description

- Frasier Suction Tube 6FR
- Frasier Suction Tube 7FR
- Frasier Suction Tube 8FR
- Frasier Suction Tube 9FR
- Frasier Suction Tube 10FR
- Frasier Suction Tube 11FR
- Frasier Suction Tube 12FR
- Frasier Suction Tube 15FR

Length

- 16 cm
- 16 cm
- 16 cm
- 16 cm
- 16 cm
- 16 cm
- 16 cm
- 16 cm

Code

- BA-503-06
- BA-503-07
- BA-503-08
- BA-503-09
- BA-503-10
- BA-503-11
- BA-503-12
- BA-503-15

Yankauer Suction Tube



Description

Yankauer Suction Tube

Length

27 cm

Code

BA-911-01

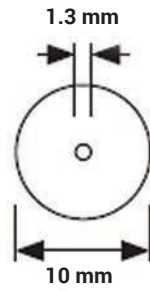

Poole Suction Tube

**Description**

Poole Suction Tube

Length

22 cm

Code

BA-914-10



SPECIALITY INSTRUMENTS

SPECIALITY INSTRUMENTS

Poole Suction Tube



Description	Length	Code
Poole Suction Tube 6mm	20 cm	BA-915-06
Poole Suction Tube 8 mm	20 cm	BA-915-08

Poole Suction Tube



Description	Length	Code
Poole Suction Tube 10 mm	22 cm	BA-916-10



Cardiac Suction Tube



Description	Length	Code
Cardiac Suction Tube 10 mm	38 cm	BA-917-38

Andrew Pynchon Suction Tube



Description	Length	Code
Andrew Pynchon Suction Tube	38 cm	BA-918-38



SPECIALITY INSTRUMENTS

Cardiac Suction Tube



Description	Length	Code
Cardiac Suction Tube 10 mm	25 cm	BA-919-25

Pediatric Cardiac Suction Tube



Description	Length	Code
Pediatric Cardiac Suction 6 mm	26 cm	BA-920-26
Pediatric Cardiac Suction 8 mm	26 cm	BA-927-26
Pediatric Suction Tube 10 mm	26 cm	BA-928-26



Pediatric Cardiac Suction Tube



Description	Length	Code
Pediatric Cardiac Suction Tube Removable Tip 6 mm	26 cm	BA-930-26
Pediatric Cardiac Suction Tube Removable Tip 8 mm	26 cm	BA-931-26
Pediatric Cardiac Suction Tube Removable Tip 10 mm	26 cm	BA-932-26

Finsterer Suction Tube



Description	Length	Code
Finsterer Suction Tube	32 cm	BA-933-32



SPECIALITY INSTRUMENTS

Yankauer Suction Tube



Description

Yankauer Suction Tube

Length

27 cm

Code

BA-934-27

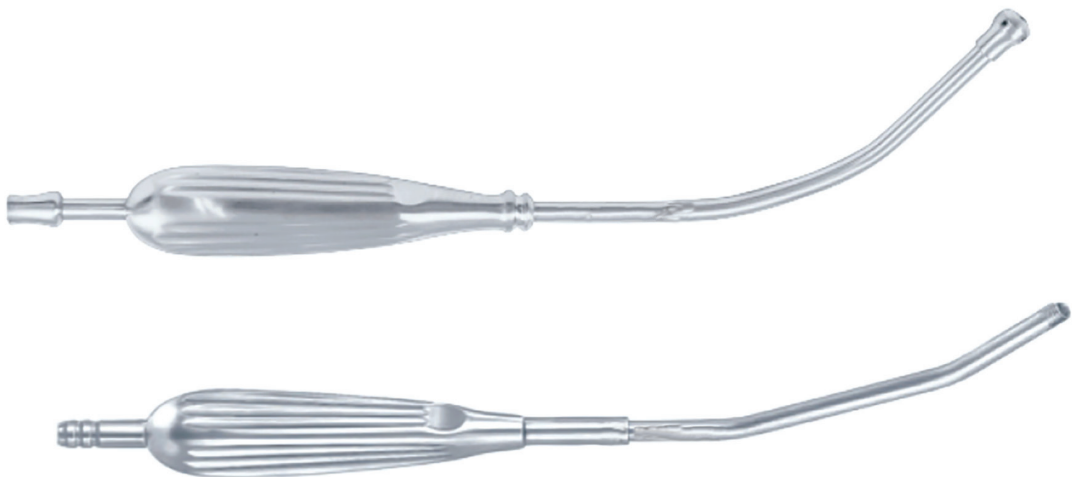

Tunneling Set



Tunneling Set

1. Handle for Tunneling Set
2. Tunneling Shafts x 3
3. Tunneling Tip x 4 (6 mm, 8 mm, 10 mm, 12 mm)
4. Vein Tip x 1
5. Luer Adaptor
6. Storage Case Stainless

Description

Tunneling Set

Code

CC-9800-00S



Tibbs Arterial Cannula



Description

- Tibbs Arterial Cannula 58 mm A
- Tibbs Arterial Cannula 58 mm B
- Tibbs Arterial Cannula 58 mm C
- Tibbs Arterial Cannula 58 mm D

Code

- BA-917-01
- BA-917-02
- BA-917-03
- BA-917-04

Ross Sump Sucker



Description

- Ross Sump Sucker Infant
- Ross Sump Sucker Child
- Ross Sump Sucker Adult

Code

- BA-918-01
- BA-918-02
- BA-918-03



Cooley Vascular Dilator

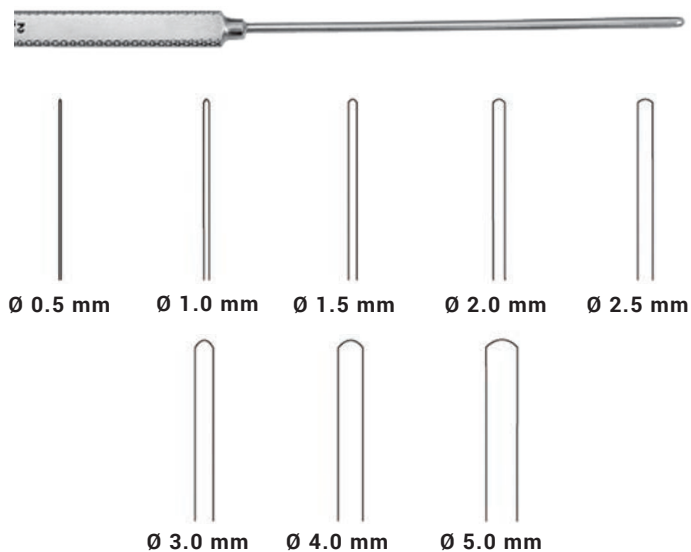

Description

Cooley Vascular Dilator 0,5 mm
 Cooley Vascular Dilator 1 mm
 Cooley Vascular Dilator 1,5 mm
 Cooley Vascular Dilator 2 mm
 Cooley Vascular Dilator 2,5 mm
 Cooley Vascular Dilator 3 mm
 Cooley Vascular Dilator 4 mm
 Cooley Vascular Dilator 5 mm

Length

13 cm
 13 cm
 13 cm
 13 cm
 13 cm
 13 cm
 13 cm
 13 cm

Code

CC-1300-01
 CC-1300-02
 CC-1300-03
 CC-1300-04
 CC-1300-05
 CC-1300-06
 CC-1300-07
 CC-1300-08



SPECIALITY INSTRUMENTS

DeBakey Vascular Dilator

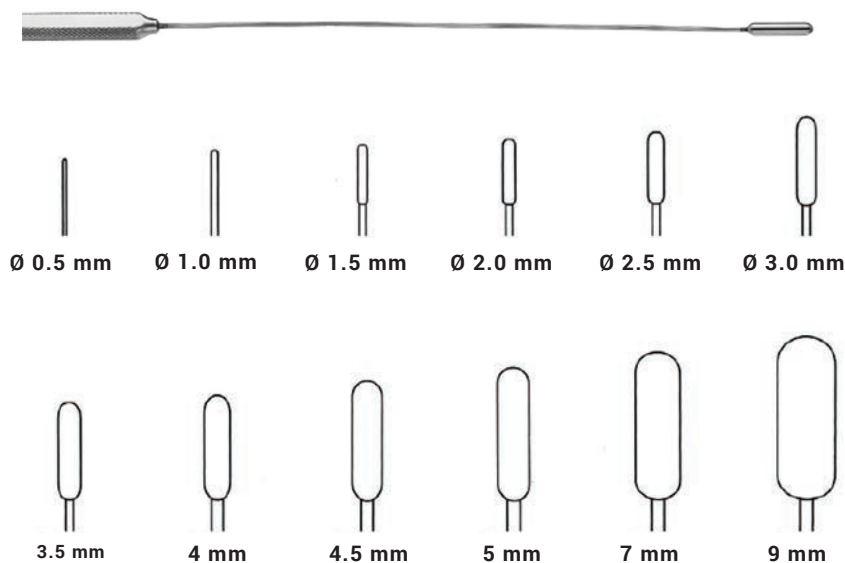
**Description**

DeBakey Vascular Dilator 0,5 mm
 DeBakey Vascular Dilator 1 mm
 DeBakey Vascular Dilator 1,5 mm
 DeBakey Vascular Dilator 2 mm
 DeBakey Vascular Dilator 2,5 mm
 DeBakey Vascular Dilator 3 mm
 DeBakey Vascular Dilator 3,5 mm
 DeBakey Vascular Dilator 4 mm
 DeBakey Vascular Dilator 5 mm
 DeBakey Vascular Dilator 7 mm
 DeBakey Vascular Dilator 9 mm

Length

19 cm
 19 cm
 19 cm
 19 cm
 19 cm
 19 cm
 19 cm
 19 cm
 19 cm
 19 cm
 19 cm

Code

CC-1400-01
 CC-1400-02
 CC-1400-03
 CC-1400-04
 CC-1400-05
 CC-1400-06
 CC-1400-07
 CC-1400-08
 CC-1400-09
 CC-1400-10
 CC-1400-11



Garrett Vascular Dilator

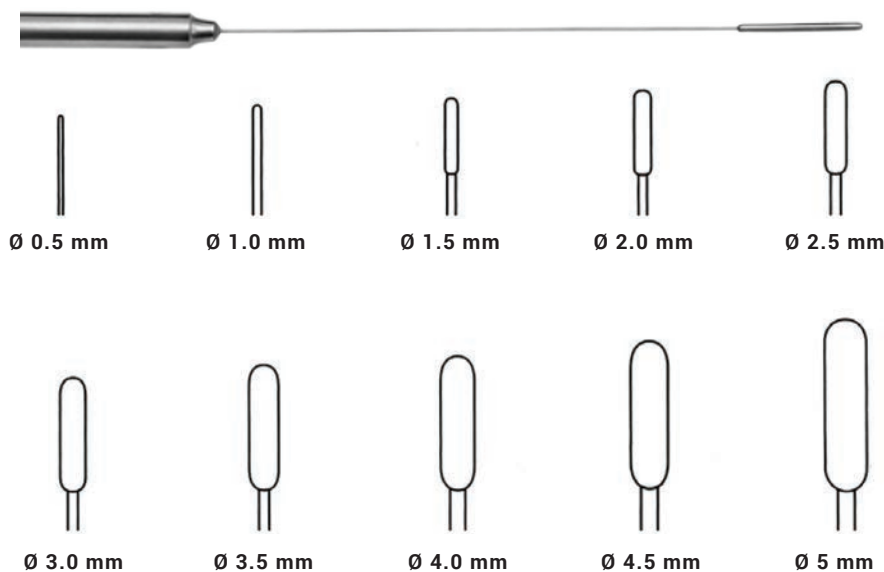

Description	Length	Code
Garrett Vascular Dilator 0,5 mm	14 cm	CC-1410-01
Garrett Vascular Dilator 1 mm	14 cm	CC-1410-02
Garrett Vascular Dilator 1,5 mm	14 cm	CC-1410-03
Garrett Vascular Dilator 2 mm	14 cm	CC-1410-04
Garrett Vascular Dilator 2,5 mm	14 cm	CC-1410-05
Garrett Vascular Dilator 3 mm	14 cm	CC-1410-06
Garrett Vascular Dilator 4 mm	14 cm	CC-1410-07
Garrett Vascular Dilator 5 mm	14 cm	CC-1410-08

Description	Length	Code
Garrett Vascular Dilator 0,5 mm	21 cm	CC-1411-01
Garrett Vascular Dilator 1 mm	21 cm	CC-1411-02
Garrett Vascular Dilator 1,5 mm	21 cm	CC-1411-03
Garrett Vascular Dilator 2 mm	21 cm	CC-1411-04
Garrett Vascular Dilator 2,5 mm	21 cm	CC-1411-05
Garrett Vascular Dilator 3 mm	21 cm	CC-1411-06
Garrett Vascular Dilator 4 mm	21 cm	CC-1411-07
Garrett Vascular Dilator 5 mm	21 cm	CC-1411-08



SPECIALITY INSTRUMENTS

Bakes Dilator Set

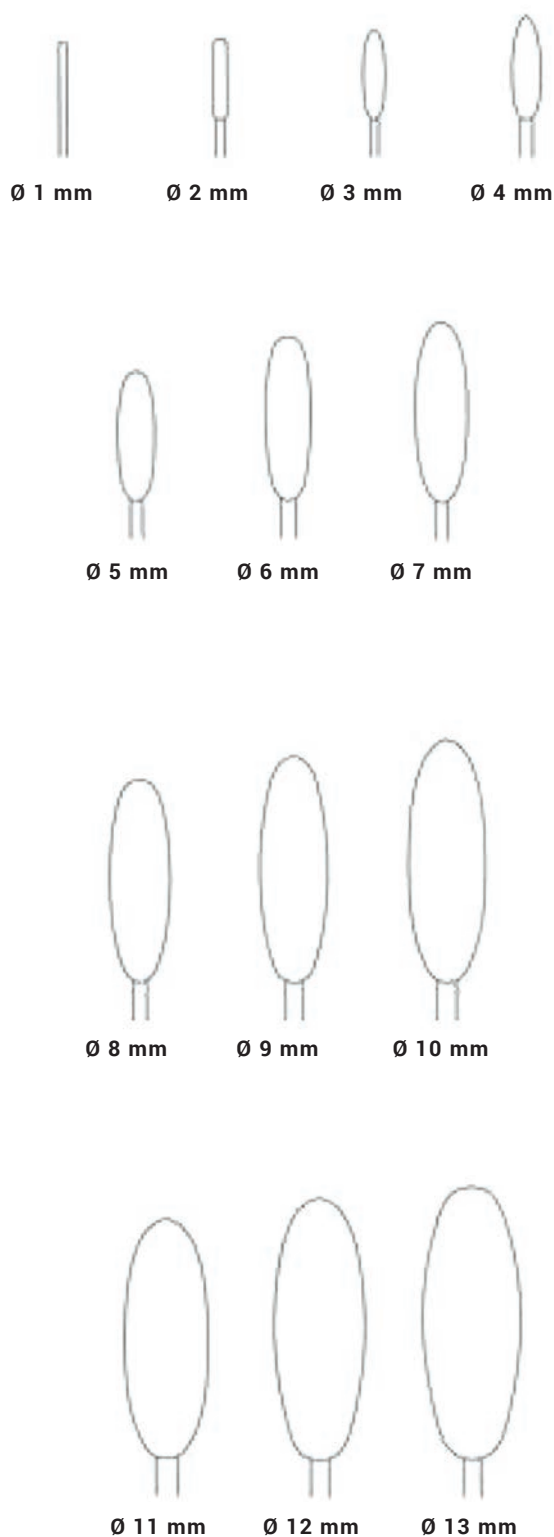

Description

Bakes Dilator Set 1mm - 13 mm
 Bakes Dilator Set 1mm - 13 mm

Length

20 cm
 31 cm

Code

CC-1415-00
 CC-1416-00

DeBakey Vascular Dilator Titanium Handle (Memory Nitinol Wire)

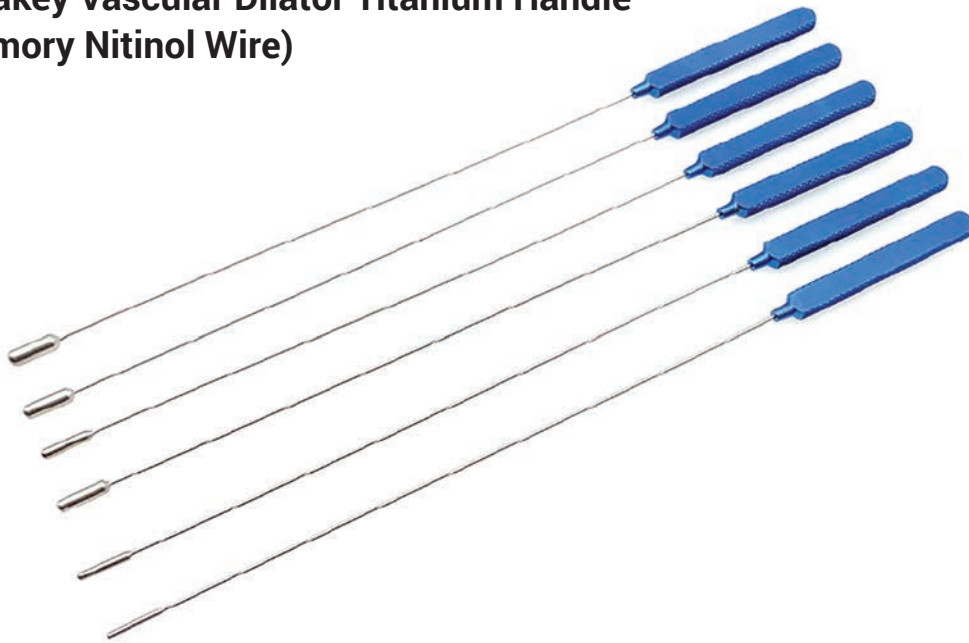

Description

DeBakey Vascular Dilator Titanium Handle 0.5 mm - 9 mm

Length

19 cm

Code

CC-1417-00

Leksell Bone Rongeur



Description

Leksell Bone Rongeur 3 mm

Leksell Bone Rongeur 5 mm

Leksell Bone Rongeur 8 mm

Length

24 cm

24 cm

24 cm

Code

EA-6221-03

EA-6221-05

EA-6221-08

Cushing Nerve Hook

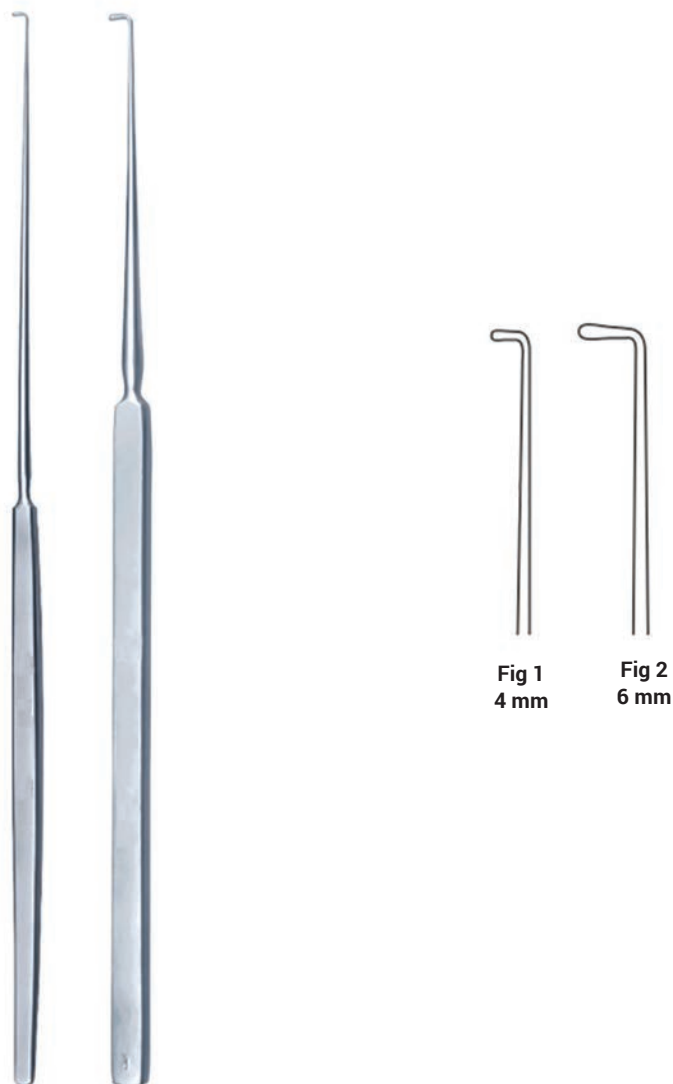

Description	Length	Code
Cushing Nerve Hook 4 mm Fig 1	19 cm	CA-3473-19
Cushing Nerve Hook 6 mm Fig 2	19 cm	CA-3474-19
Cushing Nerve Hook 4 mm Fig 1	28 cm	CA-3473-28
Cushing Nerve Hook 6 mm Fig 2	28 cm	CA-3474-28



Hegar Dilator Set



Single Ended

Double Ended

Description

1. Hegar Dilator Set 26 Pieces 1 mm x 26 mm
2. Hegar Dilator Set 8 Pieces 4 mm x 17 mm
3. Storage Case Stainless

Code

- CC-9800-01
 CC-9800-02
 CC-9800-03

Tubbs Aortic Dilator

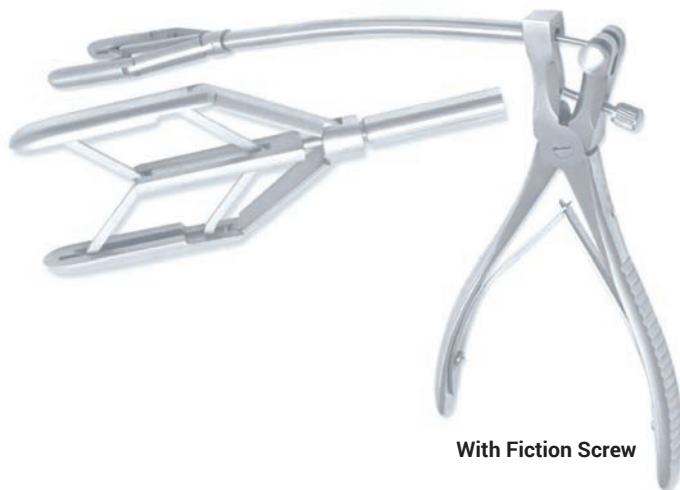

With Fiction Screw

Description

Tubbs Aortic Dilator Opening 8 mm - 42 mm

Code

CC-9800-10



SPECIALITY INSTRUMENTS

Cardiac Tube Holders

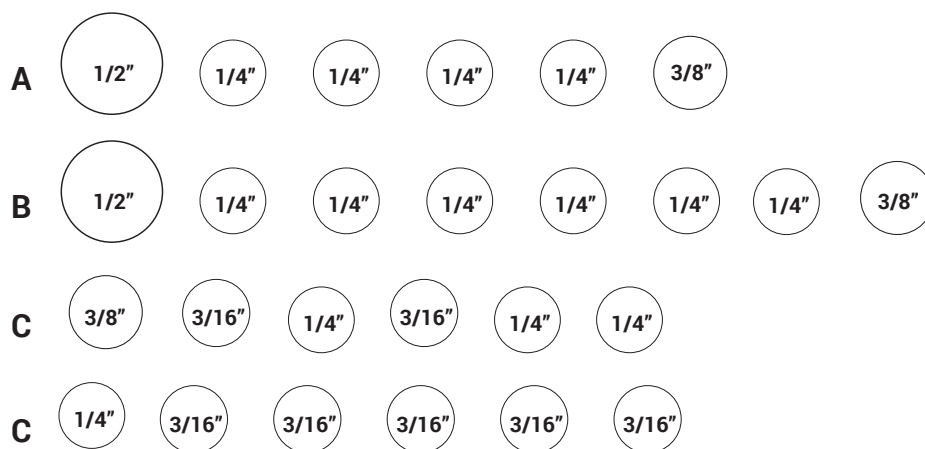
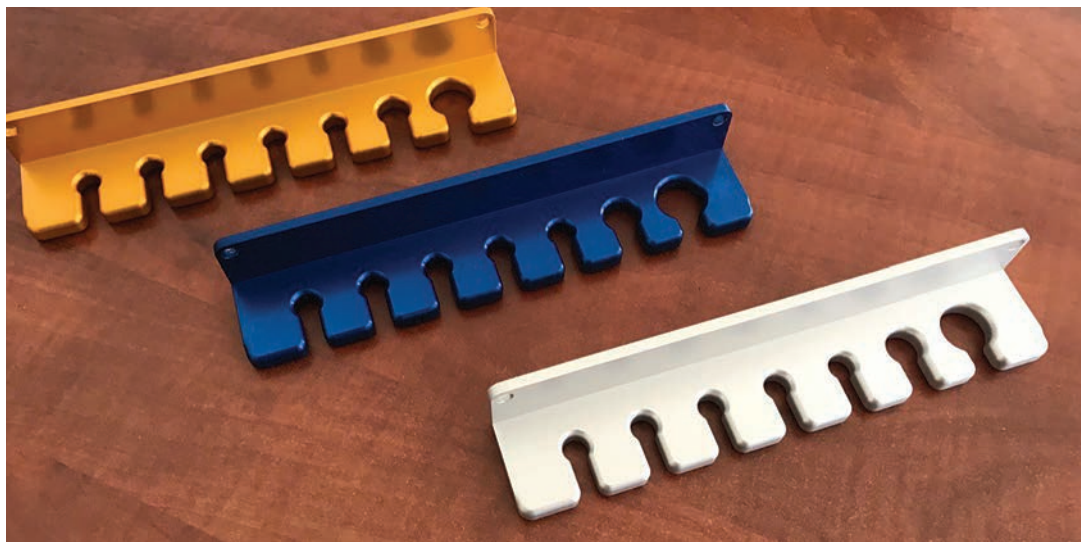

Description

Code

- A** Cardiac Tube Holders
- B** Cardiac Tube Holders
- C** Cardiac Tube Holders
- D** Cardiac Tube Holders

- CC-1800-01
- CC-1800-02
- CC-1800-03
- CC-1800-04

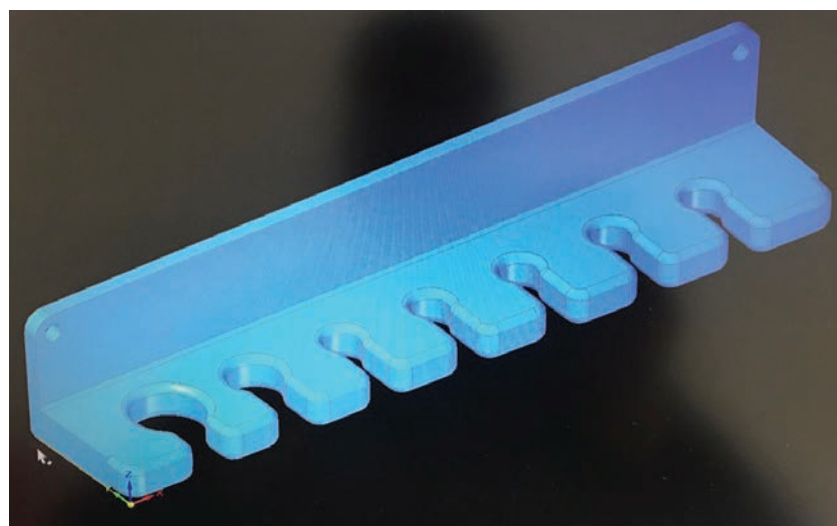

Ligature Catcher



Description

Ligature Catcher 1.5 mm
 Ligature Catcher 2 mm
 Ligature Catcher 2.5 mm
 Ligature Catcher 3 mm

Length

24 cm
 24 cm
 24 cm
 24 cm

Code

CC-1339-01
 CC-1339-02
 CC-1339-03
 CC-1339-04



SPECIALITY INSTRUMENTS

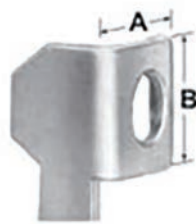



Authorised Dealer / Agent

www.skillinstruments.co.za

SKILL® Surgical Instruments
Rottweiler Street 53
D-78669 Wellendingen
Germany